

Application Note



Understanding Advanced P25 Control Channel Functions



This application note deals with an advanced form of P25 trunking using explicit messaging.¹

Explicit messaging is currently used in the VHF and UHF frequency bands and it is a feature that allows trunked P25 networks to fully exploit the flexibility that the VHF and UHF bands offer. As a precursor, we want to review some of the basic terminology regarding P25 networks, especially the difference between implicit and explicit modes of operation.

Implicit operation means that the radio's own internal

programming in conjunction with the P25 network messages will determine what channel/frequency pair the radio assigns to a particular network channel. This is also known as the "Short Channel form". The explicit mode of operation assigns the actual channel/frequency over the air by providing the exact TX and RX frequency assignments directly to the radio.

Note: Before reading this application note, it is highly recommended that the reader review the companion application note "Understanding 800 MHz and VHF/UHF Implicit P25 Control Channel Functions using the 2975". This will remove the need to review the basics of trunked radio operation and provide the reader with an understanding of control channel functions and the P25 implicit mode of operation.

Typically, the implicit mode of operation uses a technique called single block messaging, where explicit typically uses multi-block messaging to convey trunking messages. However, certain single and multi-block messages can be used on either type of network.

Review of Key Terminology

In any wireless mobile communication system, acronyms abound. P25 is no different and there are certain acronyms and terms used that the reader needs to know before using the 2975 for testing P25 radio systems. The following is a list of the most common acronyms:

ARQ	Automatic Retry Request
CAI	Common Air Interface
CRC	Cyclic Redundancy Check
EIA	Electronic Industries Alliance
EXPLICIT	The means in which the SU and FNE utilize messaging to channel assignments using advanced control channel messaging techniques
FNE	Fixed Network Equipment
GROUP ID	A collection of users assigned a particular ID number to designate them as a unique category of users
ID	Identifier
IMPLICIT	The means in which the SU and FNE utilize messaging to access pre-programmed channel parameters to establish channel assignments
INTERCONNECT	A call made to or from the Public Switched Telephone Network
ISP	Inbound Signaling Packet
ISM	Inbound System Message - occurs from the mobile to the NTS
LB	Last Block Flag - indicates if this block is last or more are to follow
LC	Link Control Word
LCF	Link Control Format
LCO	Link Control Opcode
LDU1	Logical Link Data Unit 1
LRA	Location Registration Area
LSB	Least Significant Bit
MBT	Multiple Block Trunking
MFID	ManuFacterer's Identity
MI	Message Indicator

MOBILE	For this application note, a mobile denotes either a portable or mobile.
ms	Millisecond
MSB	Most Significant Bit
NARROW BAND	12.5 kHz bandwidth operation
TX	Transmit
Octet	8 bits of information used in messaging
Opcode	Identifies the message type
OSP	Outbound Signaling Packet
P	Protected Flag
PARAMETRICS	The RF performance of a radio system including RF Error, Power and Modulation Accuracy, as well as radio sensitivity
PROTOCOL	A series of communication processes defined to set up calls and to send various forms of data to and from the mobile.
PSTN	Public Switched Telephone Network
REGISTRATION	The initial handshake process that allows the radio to communicate
RFSS	RF Sub-System
RX	Receive
SCCB	Secondary Control Channel Broadcast
SS	Status Symbols
SU	Subscriber Unit - the mobile or portable radio
SYS ID	System Identifier
TIA	Telecommunications Industry Association
TILE	This applies to the 2975. A tile is window view of various functions within the 2975. There are two tiles. One is a 1/4 tile and the other is 1/8 tile. The 1/4 tiles are used for displaying repeater simulators, minimized spectrum analyzers and oscilloscopes, and take up 1/4 of the total screen area. 1/8 tiles are used for meters and take up 1/8 of the total screen area.
TSBK	Trunking Signaling Block
WACN ID	Wide Area Communication Network Identifier

P25 Control Channel Functions

The P25 control channel is a separate channel that is designated as the control resource and is different from the traffic channel in that it functions as a resource allocation and digital communication message bearer and handler between the RFSS (RF Sub-System) and the SU (Subscriber Unit).

The P25 control channel feature for trunking is not specific (proprietary) to any P25 manufacturer or P25 RFSS configuration. All mobiles supporting P25 formats should be able to access a P25 trunking function as either standard configuration or as an optional mode of operation, depending on manufacturer and their target markets.

In the P25 standard, the control channel maintains compatibility between conventional operation in that the modulation format and the bit rate are the same. In the case of P25, the control channel is a 9600-baud (data rate) channel using C4FM modulation to transfer the digital 1s and 0s to the receiving radio.

Inbound and Outbound Control Channel Signaling Messages

The P25 control channel communicates a variety of information through signaling messages to the SU so that proper access to the system can be achieved. The P25 standard utilizes system status (overhead messages) and control messages to accomplish this.² Correspondingly, the SU sends control messages to the network to establish and update communications .

Explicit Versus Implicit Mode of Operation

In a P25 radio system, channel/frequency combinations can be programmed into the radio. These programmed values match the network channel/frequency combinations. In the channel grant, the system tells the radio, through the use of a channel identifier, what channel to select. In the implicit mode of operation, the radio internally looks up the channel identifier, and then tunes to the requested channel.

Implicit messaging typically uses single block TSBK messages. This is a relatively simple means of getting the proper information to the radio from the control channel. This works fine in bands with fixed channel assignments like the 800 MHz band (implicit messaging can be used in undefined bands as well, such as the VHF and UHF bands).

However, in undefined bands, the implicit mode of operation can limit the use and the inherent flexibility of the band. This is caused by the radio having to be pre-programmed for all the various channel/frequency combinations. If the channel is not pre-programmed, the radio cannot tune to that channel because it is simply not aware of its availability.

To remove this limitation, the explicit mode of operation was developed. This mode allows for direct assignment of radio TX and RX parameters to the radio from the network. Let's look at an example to see why this is so important.

Let's say that a mobile user is on a VHF or UHF network in Seattle. The radio in use only supports the implicit mode of operation and has the predefined look-up table of assigned frequencies pre-pro-

grammed so that it can react appropriately when the network sends the channel grant. As long as the user is in the Seattle area, with the assigned frequencies within the VHF or UHF band, the radio can communicate with the network.

However, what happens when the user moves out of the Seattle area, and needs to access the network? Let's say that the new location is Atlanta, and the individual wants to access the Atlanta network. What happens to the radio?

Most P25 radios can handle multiple pre-programmed control channels. This eliminates any problems in finding a control channel on an established network with an associated WACN ID or SYS ID that the radio recognizes. However, the Atlanta network, due to frequency allocations that are different than the Seattle VHF or UHF band, uses different channel/frequency combinations. What does the radio do? Inherently, the radio may find the control channel. However, it cannot relate the channel grants received from the network to the appropriate user channels to establish voice or data communications.

That is where explicit messaging comes into play. With explicit messaging, the radio can find the appropriate control channel through a pre-programmed control channel look up, but when the channel grant is received, the network *specifically* assigns to the radio, the appropriate TX and RX frequencies that are to be used for voice or data communications.

As the reader can well imagine, depending on the message, the explicit mode of operation requires more robust messaging from the network to accomplish its task. Some messages can use single block formats to relay the explicit channel information (for example, the Group Voice Channel Grant Update - Explicit Channel Form). Others need more data to relay the channel information, and thus, require multi-block formats to transmit the data (for example, the Group Voice Channel Grant - Explicit Channel Form).

Single Block Messaging Operation

Implicit messaging usually uses Single Block Messaging consisting of single TSBK (trunking signaling block) to provide information to the SU. It is important to realize that a network configured for explicit messaging can also use single block messages typically used in the overhead, or control messages that are used outside of the actual channel grant messages that control the channel/frequency allocations to the radio (for example, the IDEN_UP Message).

Besides a single TSBK configuration, it is also important to realize Single Block messages can be combined into two or three sequential blocks following the FS (Frame Synch) and NID (Network Identifier). This allows multiple single trunking signaling blocks to be sent consecutively. See TIA/EIA-102.AABB section 5 for more details. Do not confuse double or triple TSBK messages as explicit or extended multi-block messages.

² See the application note "Understanding 800 MHz and VHF/UHF Implicit P25 Control Channel Functions using the 2975" for more information on specific message types.

Figure 1 shows the configuration of a single TSBK. As you can see, the first two octets are used for the LB, P and Opcode information. The following 8 octets are used for the arguments or the actual message information. The final two octets are used for the TSBK CRC that is a validation check that the data was processed correctly.

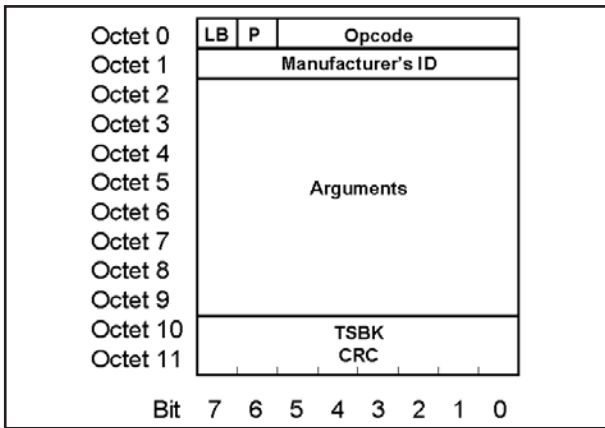

Figure 1: Single Block TSBK Format

Multi-Block Messaging Operation

Multiple Block Messaging consists of a number of Data Blocks to provide more robust data information from the RFSS to the SU and vice versa. Again, it is important to realize that a network configured for explicit messaging can also use single block messages as they relate to various overhead, or control messages, besides the actual channel grant messages that control the channel/frequency allocations to the radio.

The primary difference between single block messages and multi-block messages is that the single block message formats contain "complete" or whole messages, where the multi-block messages disperse the information over one, two or three data blocks. Multi-block messages include a header block that contains information on how many data blocks are required for the message. The header block dictates how many data blocks follow the header. Figure 2 shows the configuration for Multi-Block messages.

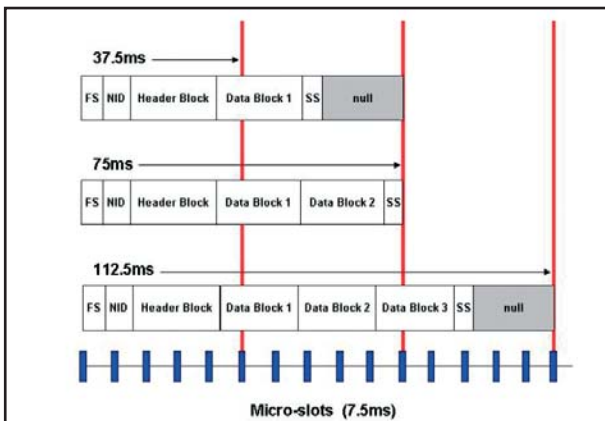

Figure 2: Multi-Block Message Formats.

It is important to understand that there are different types of header blocks depending on the information being sent. Data (non voice) message transmission uses a confirmed header block (requires an acknowledgement that the data has been received correctly). Voice communication trunking messages use an

unconfirmed header block. For the purpose of this application note we will focus on those used with the various trunked voice modes, specifically the Group Voice Channel Grant Explicit Channel Form, the Unit to Unit Voice Channel Grant - Extended Format and the Telephone Interconnect Channel Grant - Explicit Channel Form.

Figure 3 shows the Alternative Trunking Control Packet Header Block format. This format is used with the above referenced channel grant messages.

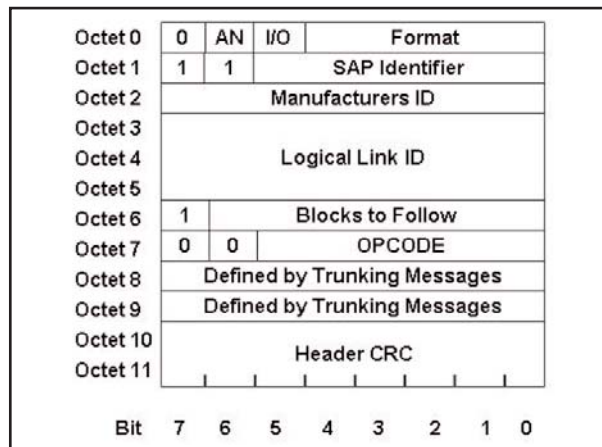

Figure 3: Alternative Trunking Control Packet Header Block

The header block indicates the type of message being sent via the Opcode field (Alternative Trunking Control Packet Header Block). This is important in the explicit messaging mode. When used with the channel grant message, the opcode indicates that the following data blocks dictate the TX and RX frequencies that are associated with the Channel Grant message. For example, the opcode for a Group Voice Channel Grant is %000000. The opcode is the same for either a single block implicit or a multi-block explicit message. Additional fields are identified as follows:

Bit 7 of octet 0: indicates that the message has multiple blocks.

The AN bit: This bit, which is number 6 of octet 0, is set to 0 to indicate that it is unconfirmed.

The IO bit: is set to 1 for outbound or 0 for inbound messages.

Format: is the type of header, either unconfirmed for Multiple Block Trunking or Alternative Multiple Block Trunking format for trunking control.

=%10101 - Unconfirmed multi-block trunking control

=%10111 - Alternate multi-block trunking control

The SAP identifier: indicates the service access point to where the data is directed. 61 indicates a non-protected Trunking control, while 63 indicates a protected trunking control message.

The MFID: or the Manufacturer ID identifies the manufacturer ID for non-standard control channel messaging. Throughout this document, the Manufacturer's ID field is to assume the standard Project 25 Manufacturer's ID of 00.

Blocks to follow: are a simple indication of the number of blocks after the header.

Header CRC: is a Cyclical Redundancy Check that verifies the reassembled transmitted bits are coded properly. The user can-

not set this field.

Octet 8 and 9 are defined by the type of message being sent. This is covered later in this application note.

Typical Explicit Control Channel Configuration

Since the P25 standard states that a control channel requires a minimum of the RFSS_STS_BCST, NET_STS_BCST and the IDEN_UP messages, the minimum configuration one would expect to see on an Explicit P25 control channel would include these messages. Although a "basic" simplified version using only the RFSS_STS_BCST and NET_STS_BCST messages would actually work in an implicit messaging environment, it would not work on in Explicit messaging system . That is because the IDEN_UP message contains data that is essential to the Explicit radio's operation. The IDEN_UP_VU message is a modified form of the message and is used for the VHF and UHF band operation.

A typical "basic" control channel configuration for Explicit messaging is shown in figure 4 where "1" would designate an IDEN_UP message, "2" would designate an RFSS_STS_BCST message and "3" would designate a NET_STS_BCST message. Please note that the RFSS_STS_BCST and NET_STS_BCST can be either multi-block format (explicit) or abbreviated form.



Figure 4: An example of a "Basic" P25 Control Channel Configuration

Now that we know how the basic messages are put together, we need to look at the messages closer to gain a better understanding of how the control channel operation works in the explicit mode.

Network Status Broadcast Message

The Network Status Broadcast message for multi-block operation contains fields or information elements as outlined in figure 5.

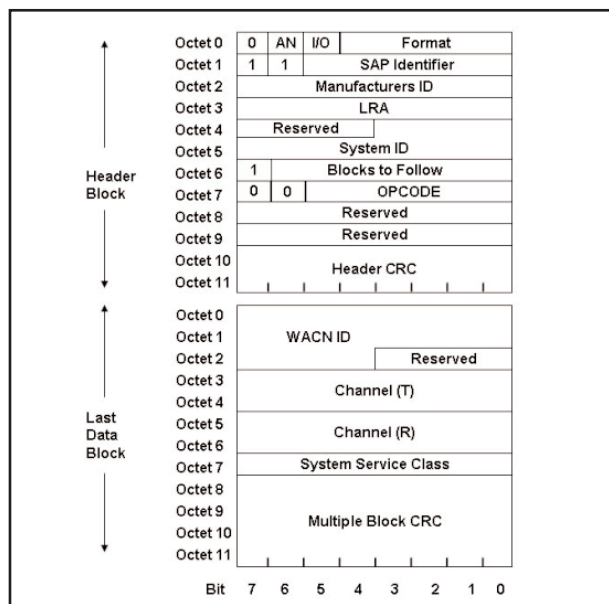

Figure 5: The Multi-Block Extended Network Status Broadcast Message

The fields within this message are defined as follows:

LRA: The LRA defines the region of a registration area in which a subscriber unit may roam without the need to indicate a location update to the network. The registration area may consist of a number of LRAs. The LRA may be a single site or a collection of sites of an RFSS. The exact meaning is up to the system designers. This is a single octet in length with valid entries of \$0000 - \$FFFF. See TIA/EIA-102 AABC and AABD.

System ID: The System ID identifies the home system in a 12-bit field. The radio may be programmed to operate in up to 8 other systems through the combination of the (WACN ID + System ID). Valid entries are \$001 - \$FFE.

Blocks to Follow: In this instance, %0000001.

Opcode: %111011

The WACN ID: This field is a 20 bit field that sets the home network identity which is hard coded into the radio SU through the use of a data interface. This dictates the Home network upon which the radio can work. Valid entries are \$0 0001 - \$F FFFE.

Channel (T): This is the actual channel assigned to the Transmit frequency of the RFSS control channel. The actual calculation used to obtain this will be discussed further on in this application note

Channel (R): This is the actual channel assigned to the receive frequency of the RFSS control channel. The actual calculation used to obtain this will be discussed further on in this application note

System Service Class: This is the 8-bit System Service Class field that indicates the basic functions of what the control channel will support. The defined values are:

- \$01 - composite control channel
- \$02 - no service requests; update control channel only
- \$04 - backup control channel only
- \$08 - reserved for future definition
- \$10 - data service requests only
- \$20 - voice service requests only
- \$40 - registration services only
- \$80 - authentication service only

These values may be ORed together to give different service class definitions. A few of the many possibilities are given below for examples. Other values not listed here are also allowed.

- \$00 - no services, either trunked or conventional
- \$F0 - all service, not a backup control channel

RFSS Status Broadcast Message

The RFSS Status Broadcast (RFSS_STS_BCST) messages contain fields or information elements as outlined in figure 6.

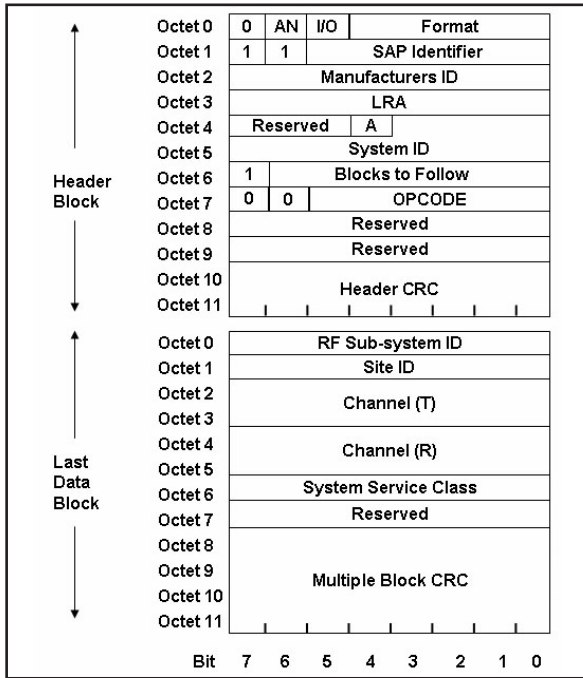

Figure 6: The Multi-Block Extended RFSS Status Broadcast Message

The RFSS Status Broadcast message provides additional information about the sub-system capabilities. It shares some of the same fields as the Network Status Broadcast Message, but also has additional fields as follows:

A: This field in the RFSS_STS_BCST message will specify if the site has an active network connection with the RFSS controller, i.e., communication with other sites is possible. A value of 1 will indicate a valid RFSS network connection is active.

RFSS ID: The 8-bit RFSS ID field identifies the RF subsystem in a P25 network. Valid entries are \$01 - \$FE. See TIA/EIA-102 AABD for more information.

Site ID: The 8-bit Site ID field indicates the identity of the site. The Site ID is unique within an RFSS. Valid entries are \$01 - \$FE. See TIA/EIA-102 AABD for more information.

IDEN_UP and IDEN_UP_VU Messages

IDEN_UP Messages

The IDEN_UP and IDEN_UP_VU messages contain fields or information elements as outlined in the following figures 7 and 8. The purpose of the IDEN_UP messages is to provide a baseline for the radio and then to start calculation of the appropriate TX and RX frequencies.

The primary difference between the two messages is that the IDEN_UP is used for frequencies outside the VHF/UHF band, where the IDEN_UP_VU is used specifically in the VHF/UHF band (136 MHz to 172 MHz and 380 MHz to 512 MHz). Figure 7 shows the IDEN_UP message structure.

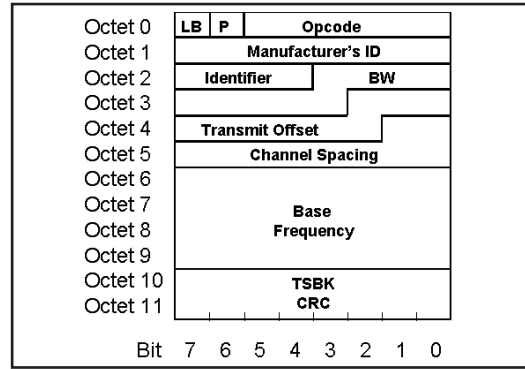

Figure 7: The IDEN_UP message

For the IDEN_UP message, the fields are defined as follows:

Identifier Field: This is the assigned identifier for the channel. It is a 4-bit field used as a reference for a set of frequencies and channel characteristics, and it is also used to determine the corresponding frequency information. Each control channel can send multiple IDEN_UP messages with different corresponding frequency information, and there can be up to 16 unique channel set references allowed for each control channel.

BW: This defines the receiver bandwidth and uses this information in a calculation to determine the actual bandwidth. The formula used to determine the bandwidth (kHz) is $(BW) \times (0.125 \text{ kHz})$. The BW value of zero is reserved and currently not valid.

Transmit Offset: This field represents the separation from the subscriber receive frequency to the subscriber transmit frequency and is a multi-part field where particular bits indicate different functions. The most significant bit, b8 (octet 3, bit 2), is used to describe the relationship between the TX and RX frequency and is known as the High/Low flag. If the bit is set to zero (0) then the SU transmit frequency is less than the SU receive frequency. Consequently, if the bit is set to one (1), then the SU transmit frequency is greater than the SU receive frequency.

The actual value of the offset is then determined by the remaining 8 bits. The transmit offset frequency (MHz) is computed as $(\text{offset value}) \times (0.250 \text{ MHz})$.

Therefore, if $b8 = 0$, then this frequency is subtracted from the computed SU RX frequency. If $b8 = 1$, then this frequency is added to the computer SU RX frequency.

The value of \$00 is reserved to indicate that transmit and receive occur on the same frequency. A value of \$80 is reserved to indicate that there is no standard transmit offset associated.

Channel Spacing: This is a frequency multiplier for the channel number. It is used as a multiplier in other messages that specify a channel field value. The channel spacing (kHz) is computed as $(\text{Channel Spacing}) \times (0.125 \text{ kHz})$.

Base Frequency: This field determines the absolute frequency which is used to determine the frequency for a channel assignment as referenced by an Identifier. The frequency is calculated as $(\text{Base Frequency}) \times (0.000005 \text{ MHz})$. A Base Frequency value of zero is reserved and not valid.

IDEN_UP_VU Messages

The Identifier Update for VHF/UHF bands is slightly different than the IDEN_UP message used outside the VHF and UHF bands. The two fields affected are the BW and Transmit Offset fields. Of course, the base frequency field must contain information regarding frequencies that are only valid in the VHF/UHF bands. The IDEN_UP_VU message uses a shorter (more defined) BW field and a longer, more flexible Transmit Offset field. Figure 8 shows the IDEN_UP_VU message with the longer Transmit Offset VU field.

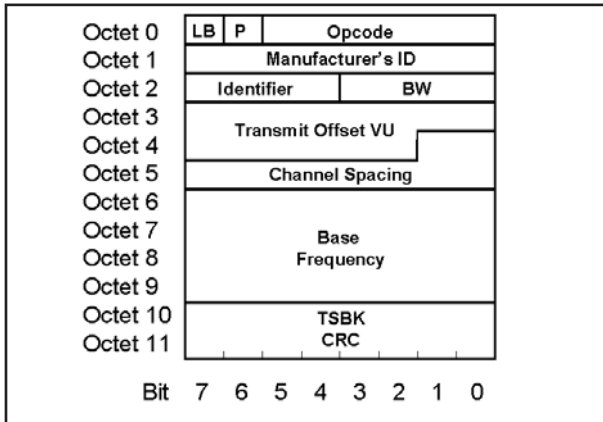

Figure 8: The IDEN_UP_VU Message

In the IDEN_UP_VU Message, the two fields affected are defined as follows:

BW VU: This field (octet 2, bits 3-0) takes on the following values for receiver bandwidth.

%0000 - %0011 reserved

%0100 6.25 kHz receiver bandwidth

%0101 12.5 kHz receiver bandwidth

%0111 - %1111 reserved

These values are essentially non-variable and only the values above are used in a VHF/UHF mode of operation.

The BW field differs in that the IDEN_UP uses a calculated field, whereas the IDEN_UP_VU message uses a shorter, more defined structure limited to 6.25 kHz and 12.5 kHz, respectively.

Transmit Offset VU: This field of 14 bits represents the separation from the subscriber receive (SU RX) frequency to the subscriber transmit frequency and is a multi-part field.

The most significant bit (octet 3, bit 7) is used to describe the relationship between the TX and RX frequency. If the bit is set to zero (0) then the SU transmit frequency is *less than* the SU receive frequency and therefore the sign is -1. Consequently, if the bit is set to one (1), then the SU transmit frequency is *greater than* the SU receive frequency and therefore the sign is +1. This is then followed by the actual offset information in the remaining 13 bits (octet 3, bits 6-0) and (octet 4 bits 7-2).

It is important to note that the IDEN_UP_VU message can be used with either implicit or explicit messaging.

The IDEN_UP message is used to inform the subscriber unit of the channel parameters to associate with a specific channel identifier. For example, an identifier will have an associated base frequency, transmit offset, bandwidth and channel spacing. Each system can have multiple identifiers (up to 16). For implicit P25 radios, the IDEN_UP message provides information about the network, but in actuality already provides information programmed into the radio.

Registration in a P25 Trunked System

As with most trunking systems, the P25 format requires that the SU register with the RFSS or network. This is done when the user turns on the mobile radio or when the user moves into a new zone. The primary purpose for registering a SU with the network is to ensure that only authorized users access the network, and that the network can track where the SU is located. This reduces the amount of time and resources that the network needs to locate the mobile, reducing call setup time and control channel loading.

There are two types of registration in a P25 trunked network, a full registration and a location registration. In a full registration the network will check the validity of the SU. A full registration occurs when the SU is first switched on, enters a new registration area, the user selects a new network or when the RFSS requests registration.

During a location registration, the SU monitors the control channel and then performs a location register in the event the user has moved to another site within the coverage area.

In both cases, the registration can be protected (encrypted) for enhanced security. Figure 9 shows a typical full registration process. The blue messages are ISPs and the red messages are OSPs.

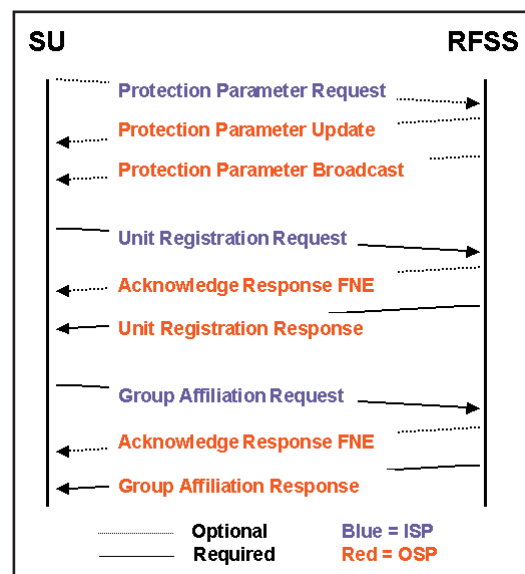

Figure 9: Full Registration Process

Unit Registration Request and Group Affiliation Request (SU Originated ISP)

If we look at the registration process, the basic implementation requires a registration message and an affiliation message. The first is the Unit Registration Request (U_REG_REQ). This is from the mobile to the RFSS and uses a single TSBK format. The detailed Unit Registration Request message from the radio is shown in figure 10.

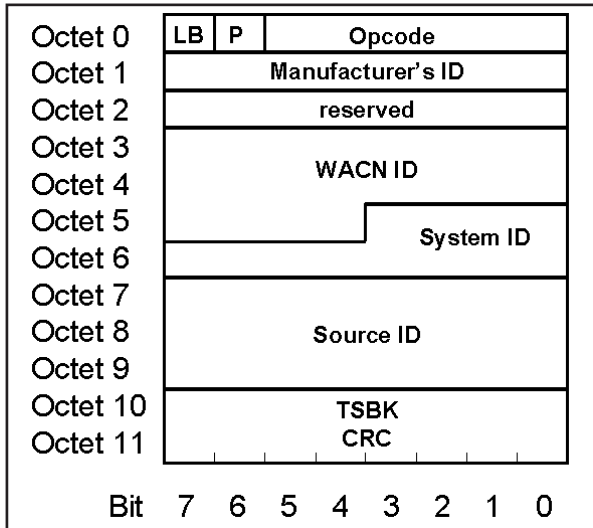

Figure 10: Unit Registration Request (Originated from the Mobile Radio)

All the definitions noted earlier for the network status broadcast and RFSS status broadcast messages OSPs apply. In addition, however, there is a new field, not previously defined, called Source ID.

Source ID: A 24-bit unit identity portion of the unique subscriber unit identity. This field along with the WACN ID and System ID uniquely addresses a subscriber unit. This can also be called the Unit ID.

Note that the subscriber unit has the appropriate WACN ID that is echoed back to the network for verification that the SU accepted the Wide Area Communication Network code. This message utilizes the Last Block flag identifier field, the encryption P-Bit and the appropriate Opcode that identifies this message as a Unit Registration Request. The System ID is preprogrammed into the SU as is the Source ID (UID). Manufacturer ID is also shown, which for a P25 system is 00.

Unit Registration Response (RFSS Originated OSP)

This message tells the subscriber unit how its request was handled by the network and, if accepted, it includes an assigned Source Address which "tells" the SU what its "new" identifier is. This Source Address is also known as the unit's new "WUID" or working unit ID. A single TSBK format is used if the WACNID of the RFSS matches the WACN ID in the SU. Figure 11 shows the Unit Registration Response message.

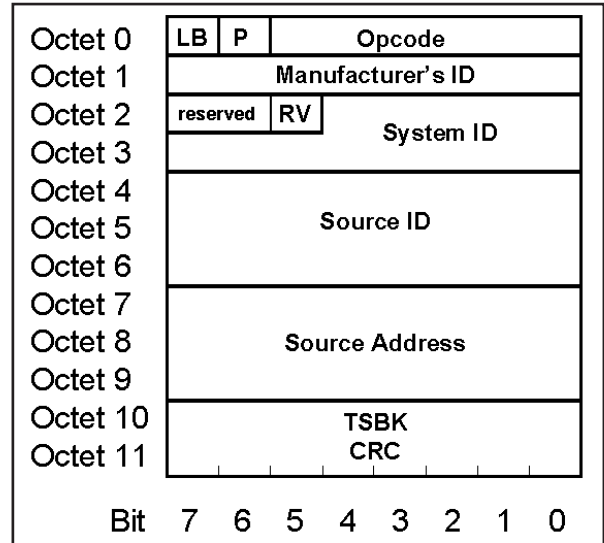

Figure 11: The Single TSBK Unit Registration Response message.

The Unit Registration Response assigns the new Source Address (WUID) and the RV field. Their functions are defined as follows:

RV: The RV field is a 2-bit field that designates the Registration Value. The following values are defined.

%00 = REG_ACCEPT indicates that registration is accepted.

%01 = REG_FAIL indicates that the RFSS was unable to verify registration.

%10 = REG_DENY indicates that registration is not allowed at the location.

%11 = REG_REFUSED indicates that the WUID is invalid but the SU need not enter the control channel hunt and the SU may attempt to re-register after a user stimulus.

See TIA/EIA-102-AABC for more information.

WUID: Within a Registration Area, each Subscriber Unit is assigned a unique abbreviated address known as the Working Unit ID (WUID) as indicated by the Source Address field. Once a SU has been assigned a WUID for a Registration Area, the WUID will normally be used to address the SU. The SU will use a WUID to identify target addresses whenever possible or appropriate. The WUID is a 24-bit field.

While within the registration area, a SU will be able to respond to messages that are addressed to its WUID. Also, while in the domain of the registration area, a SU shall initiate messages using its WUID for that registration area. Valid entries are \$00 0001 - \$FF FFFD. See TIA/EIA-102 AABD for more information.

In some instances the assigned WUID will be the same Unit ID or Source ID received by the SU in the Unit Registration Request. This is an automatic copy back function that simply reassigns the SU's Unit ID as its WUID.

If the WACN ID of the RFSS and the SU do not match, the RFSS sends a multi-block extended message that can be used in con-

junction with the Roaming Address Command (ROAM_ADDR_CMD) from the RFSS to establish a new WACN into the SU's Roaming Address Stack. This would be contingent upon the network establishing the validity of the SU to allow roaming. For this application note, we will assume a valid WACN ID is found. See TIA/EIA-102.AABC and AABD for more details.

Group Affiliation Request (SU Originated ISP)

After a registration request, the SU will send a Group Affiliation Request (GRP_AFF_REQ). The detailed Group Affiliation Request message is shown in figure 12

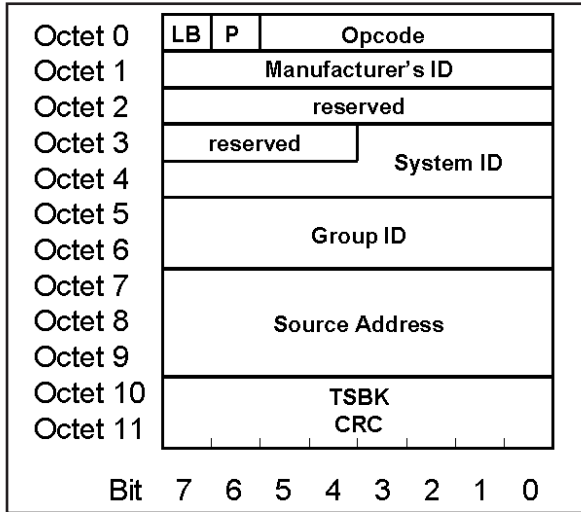

Figure 12: Group Affiliation Request (Originated from the Mobile Radio)

The message contains some of the fields that the Unit Registration Request contains, except that the WACN ID is removed and the Group ID field is added. This message can be invoked by the RFSS at any time by broadcasting the Group ID Query command. The Group ID is pre-programmed into the SU.

Group ID: This defines the 16-bit group identifier that together with the WACN ID and System ID uniquely defines a group.

Again, if the WACN ID of the RFSS and the SU do not match, the SU sends a multi-block extended message that includes the SU's WACN ID. For this application note, we will assume a valid WACN ID is found. See TIA/EIA-102.AABC and AABD for more details.

Group Affiliation Response (RFSS Originated OSP)

The Group Affiliation Response message from the network assigns A Group Address to the SU, i.e., the "WGID". The WGID works similarly to the WUID. Figure 13 shows the Group Affiliation Response message.

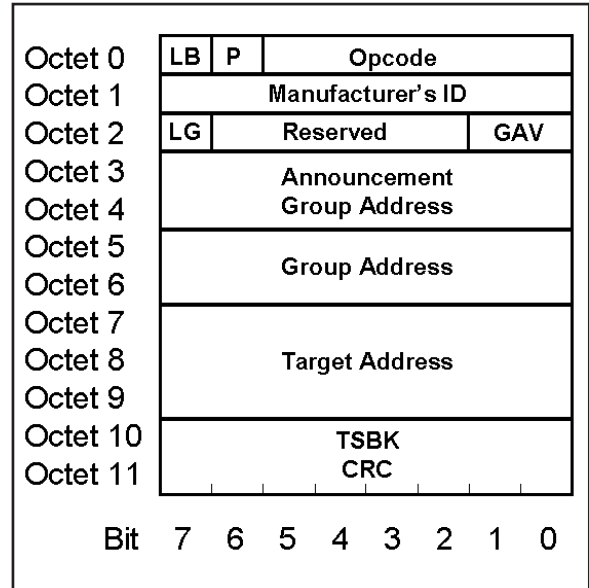

Figure 13: The Group Affiliation Response Message

Announcement Group Address: This field denotes a special group address which addresses a grouping of groups. This is unique within a system. There needs to be some prior arrangement to associate the groups to an announcement group address.

WGID: Here the group address is now the WG ID. Within a system, a SGID or Subscriber Group ID (comprised of the WACN ID, System ID and Group ID) is assigned a unique abbreviated address known as the Working Group ID (WGID). This is a 16-bit field. See TIA/EIA-102 AABD for more details.

A WGID may be assigned to more than one SU, but will only be associated with a single SGID at any given time. The 16-bit address space of the WGID is customer defined to accommodate dynamic address capability. Valid entries are \$0001 -\$FFFE. See TIA/EIA-102 AABD.

As with the WUID, in some instances the assigned WGID will be the same subscriber Group ID received by the SU in the Group affiliation request. This is an automatic copy back function that simply reassigns the SU's Group ID as the WGID.

LG: The LG bit indicates Local or Global affiliation.

LG=0 for Local and

LG=1 for Global

GAV: The GAV argument is a Group Affiliation Value.

%00 = AFF_ACCEPT indicates affiliation acceptance.

%01 = AFF_FAIL indicates affiliation failure.

%10 = AFF_DENY indicates affiliation denial.

%11 = AFF_REFUSED indicates that the WGID is invalid and that the SU need not enter the control channel hunt and the SU may attempt to re-affiliate after a user stimulus.

The abbreviated format is used if both the source and target SU have the same HOME system designation, *and* the target unit resides in the HOME system. If not, an extended Group Affiliation Response is sent. For the purposes of this application note, we will assume that the SU have the same HOME system designation and that the target unit resides in the HOME system.

Understanding Group, Unit and PSTN Call Sequences

As the call is initiated and managed, additional messages are involved in the call sequence. For example, Figure 14 shows the required messages to establish a P25 unit to group voice call after the Unit Registration and Group Affiliation process is complete.

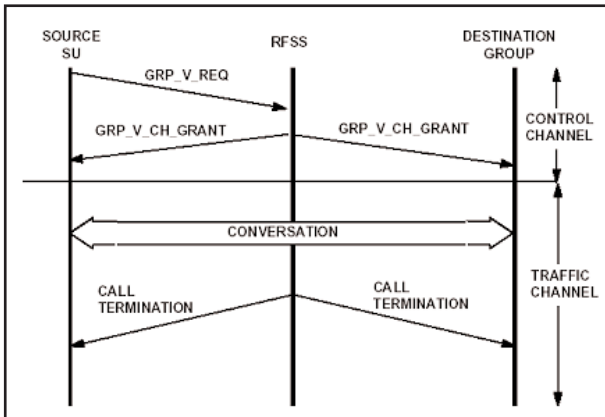

Figure 14: Unit to Group Call Sequence Chart

Once the mobile is registered and has affiliated, the only commands required to move the mobile to a particular channel, is to issue a channel grant after a Group Voice Request from an SU.

The Unit to Unit channel grant is more detailed in that the required communications from the Source SU through the RFSS to the Destination SU requires the issuing of an answer request from the RFSS and an answer response from the Destination SU. Figure 15 shows the call sequence for a Unit to Unit call.

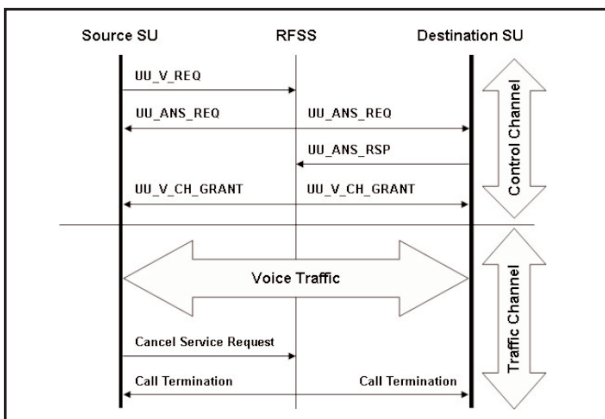

Figure 15: Unit to Unit Call Sequence Chart

The Unit to PSTN call requires interaction between the RFSS and the PSTN. The P25 Air interface messages require a PSTN interconnect request, either using a dial request or a PSTN request. The dial request includes actual digits dialed, and can be up to 10 digits - or more than 10 digits, using the extended or multi-block messaging. The PSTN request is a user defined reference

associated with a dialing sequence. Figure 16 shows the Unit to PSTN interconnect call process.

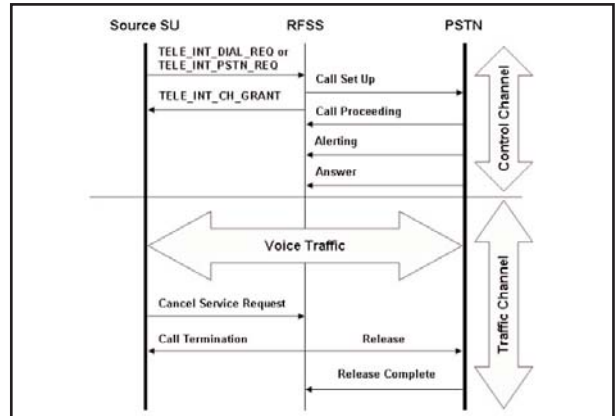

Figure 16: Unit to PSTN Call Sequence Chart

Establishing a Group Call in an Explicit P25 Trunked System

As in any communication system, a user initiates a call. This call can be defined as two types, either a SU originated call or a SU terminated call. The difference is that the SU either generates the call request or the SU receives a call request. Either action ends up with a channel grant being delivered to the SU to begin voice communications. In Figure 14 above, the group call sequence begins with a Group Voice Request from the SU to the RFSS. Let's look further at the messages involved in this transaction.

Group Voice Request (SU Originated ISP)

The SU will send this when initiating the Unit to Group call sequence. Here, an additional message is sent, the Group Voice Request (GRP_V_REQ). This message is shown in Figure 17.

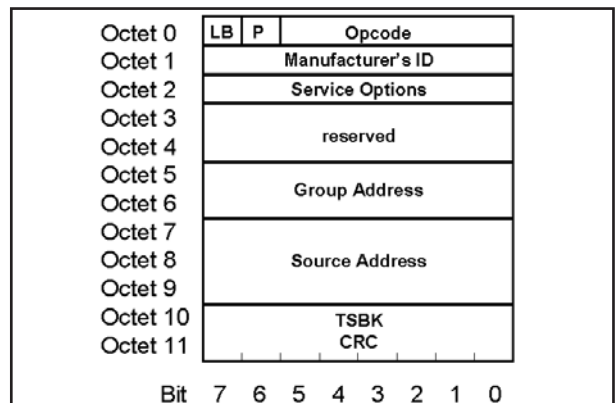

Figure 17: Group Voice Request Message

Note that this message reflects the newly created WG ID as the Group Address. It also contains a new field as follows:

Service Options: Service requests and service grants allow for special service extensions called the Service Options field. This feature provides extended flexibility to tailor the requested service to the needs of the requesting unit or process capability of the system. Figure 18 shows the Service Option field definition.

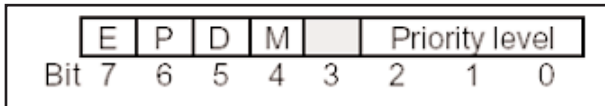

Figure 18: The Service Option Octet

The following are definitions for each bit:

- 7: **Emergency** - this is the status indication to determine if this service is to be specially processed as an emergency service.
 - 0 = Non-emergency - indicates the normal processing status.
 - 1 = Emergency - indicates special processing required.

- 6: **Protected** - indicates whether the resources (other than control channel resources) to be associated with this service should be presented in protected mode (e.g. encrypted) or not.
 - 0 = not protected - indicates normal mode presentation for the resource(s).
 - 1 = protected - indicates protection mode presentation for the resource(s).

- 5: **Duplex** - indicates the way the channel resource is to be utilized by the unit(s) involved in the call.
 - 0 = Half duplex - indicates the unit will be capable of transmitting but not simultaneously receiving on an assigned channel.
 - 1 = Full duplex - indicates the unit will be capable of simultaneous transmit and receive on an assigned channel.

- 4: **Mode** - this is the indication of whether this service session should be accomplished in a packet mode or circuit mode.
 - 0 = Circuit mode - will utilize resources capable of supporting circuit operation.
 - 1 = Packet mode - will utilize resources capable of supporting packet operation.

- 3: **Reserved** - currently set to null (0)

- 2-0: **Priority level** - indicates the relative importance attributed to this service where:
 - %111 Highest (top)
 - %110 System definable
 - %101 System definable
 - %100 Default
 - %011 System definable
 - %010 System definable
 - %001 Lowest (bottom)
 - %000 Reserved

Group Voice Channel Grant (RFSS Originated OSP)

It is important to note that the Group Voice Channel Grant contains both the "WUID" and "WGID". The fields are derived from the previous dialog between the SU and the RFSS during the registration and affiliation processes, and ensure that the SU only responds to channel grants that apply to his unique unit and group identifiers.

After the Group Voice Request is received, the RFSS responds with a Group Voice Channel Grant message (GRP_V_CH_GRANT). In the explicit mode of operation, this message is sent as a multi-block message. Figure 19 shows the Group Voice Channel Grant Explicit message. Notice the channel information section shown in Octets 2, 3, 4 and 5 of the last data block where the actual TX and RX frequencies are set.

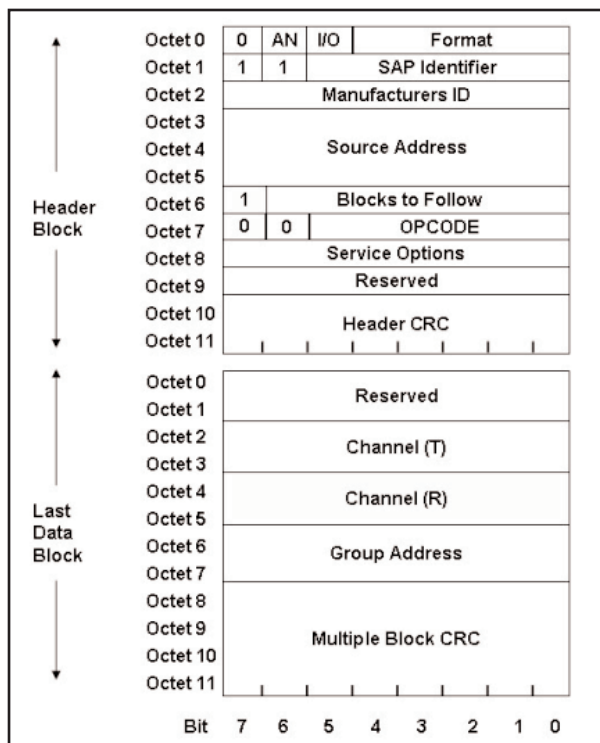

Figure 19: The Group Voice Channel Grant Explicit Message

The Channel (T) field identifies the transmit frequency of the FNE (the SU RX) and the Channel (R) field identifies the receive frequency for the FNE (the SU TX). Each Channel field is actually comprised of two elements of information. The first element is the Channel Identifier, which determines the band of frequencies that are associated with the Channel Number. As we discussed earlier, there are up to 16 unique identifiers per site and each identifier will include information such as base frequency, channel spacing, transmit offset and bandwidth. In the explicit mode of operation, this information coincides with the information sent in the IDEN_UP_VU message.

The second element is the Channel Number, which contains a value to be used to derive the actual frequency of the channel. The SU receive frequency is computed from the base frequency and channel spacing information from the IDEN_UP message and channel number from the GRP_V_CH_GRANT as follows:

SU RX = (Base Frequency) + (Channel Number) x (Channel Spacing). Figure 20 shows the channel information broken into its two elements.

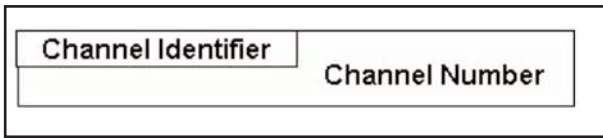

Figure 20: The Channel Information

How Mobiles Calculate the RX and TX Frequencies

In the explicit mode of operation, the SU will use the channel identifier information and the channel number in conjunction with the IDEN_UP_VU message to calculate the SU RX and SU TX frequencies.

Calculating the SU RX Frequency

The SU RX Frequency is calculated as follows:

SU RX = (Base Frequency) + (Channel Number) x (Channel Spacing).

Note: Base Frequency is calculated as (Base Frequency) x (0.000005 MHz) from the IDEN_UP_VU message. See TIA/EIA-102 AABC-2 section 2.3.5.

We know that both the Base Frequency and the Channel Spacing are derived from the IDEN_UP_VU message. The transmitted Channel Number from the Group Voice Channel Grant Explicit message becomes the key part of the equation for frequency assignments.

Calculating the SU TX Frequency

The SU transmit base frequency is computed as follows:

Using the Transmit Offset VU field from the IDEN_UP_VU message, the SU TX Frequency is simply: Sign (Transmit Offset x Channel Spacing x 12500).

That value is then added to the SU RX frequency.

Establishing a Unit to Unit Call in an Explicit P25 Trunked System

The Unit to Unit call process is very similar to the Group call process with the exception that the group voice request is replaced by the unit to unit voice service request (UU_V_REQ). The UU_V_REQ can be either a single block or multi-block format. The single block operates in the same manner as the GRP_V_REQ whereas the multi-block is an optional configuration that adds the WACN ID and the System ID to provide a more flexible address for the target SU if it is outside its home system. For this application note, we will use the single block format. See TIA/EIA-102.AABC for more details. Figure 21 shows the UU_V_REQ single block format.

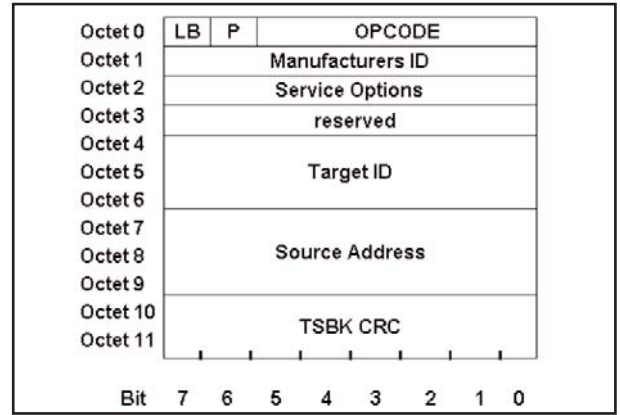

Figure 21: The UU_V_REQ Message Single Block Format

As can be seen, everything is the same as the GRP_V_REQ message except that the Target ID has replaced the Group Address. Once the UU_V_REQ has been received, the RFSS sends a UU_ANS_REQ which the target SU picks up and, if available, responds to the RFSS with a UU_ANS_RSP message indicating that it will accept the call. Figure 22 shows the UU_ANS_REQ message.

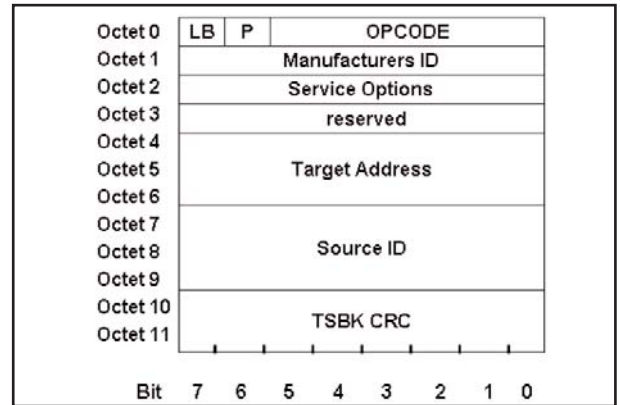

Figure 22: The UU_ANS_REQ Message

In this outbound message (OSP), the Target Address replaces the Target ID and the Source ID replaces the Source Address compared to the UU_V_REQ which is an inbound message (ISP). Again, the multi-block mode can be invoked if either user is outside the home system. Once this message has been issued, the Targeted SU for the unit to unit call can reply with the UU_ANS_RSP which indicates that the user is available to accept the call. Figure 23 shows the UU_ANS_RSP.

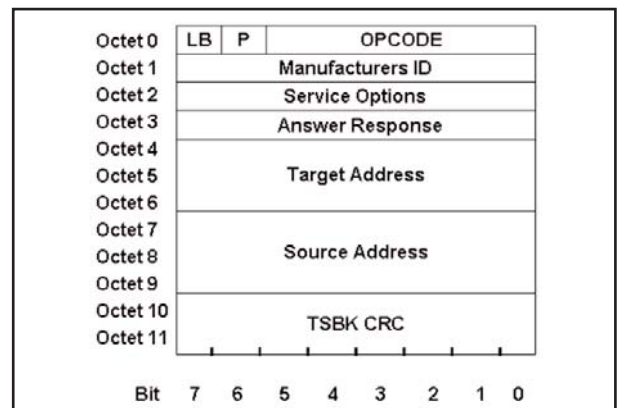

Figure 23: The UU_ANS_RSP message

With this message response, the user can send one of three "Answer Responses". These include:

- \$20 - Proceed
- \$21 - Deny
- \$22 - Wait

With an acceptable response (Proceed), the RFSS then sends a UU_V_CH_GRNT message assigning the two units in the call to a particular frequency. In this instance, we will show the explicit mode (multi-block) messaging in figure 24. After the call is done, the SU can issue a cancel service request to terminate the call.

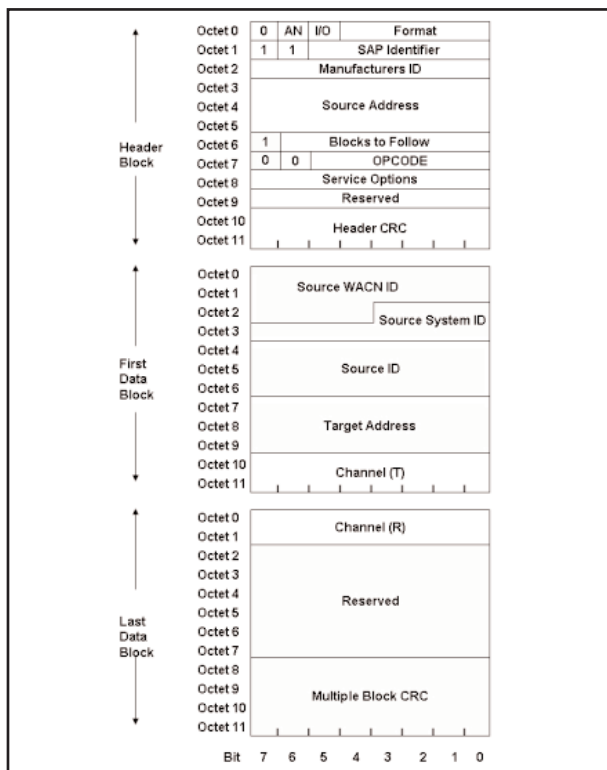

Figure 24: The UU_V_CH_GRANT Message.

The explicit mode of operation is shown with both the transmit and receiver parameters detailed along with the extended addressing including the WACN ID and source System ID.

Establishing a PSTN Call in an Explicit P25 Trunked System

Similarly to the way the Group call and Unit to Unit call operates, the PSTN differs in that the call can originate from the SU to the RFSS and then on to the PSTN, or it can originate from the PSTN to the SU through the RFSS. If the SU originates the request, it can originate two types of calls. One type is a PSTN request known as a TELE_INT_PSTN_REQ where the SU sends a PSTN address that is 8 bits refers to a PSTN dialing sequence referenced in the network. The other type is a TELE_INT_DIAL_REQ that specifically (explicit) indicates the numbers to be dialed. Figure 25 shows the TELE_INT_DIAL_REQ format and Figure 26 shows the TELE_INT_PSTN_REQ format.

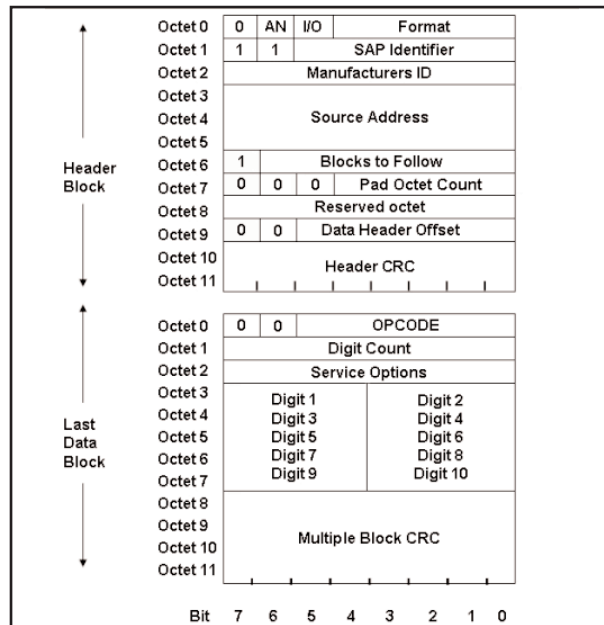

Figure 25: The TELE_INT_DIAL_REQ Message

This particular message uses a different format from the previous messages in that the OPCODE field in the header block has been replaced by a Pad Octet Count. This is actually the standard Trunking Control Packet Header Block and it is used because there is another alternative that allows up to 34 digits to be dialed and requires another data block to accomplish this. The pad octet count allows the RFSS to determine the number of blocks to follow. See TIA/EIA-102.AABB for more details. As we can see, the actual dialed digits are included in this message.

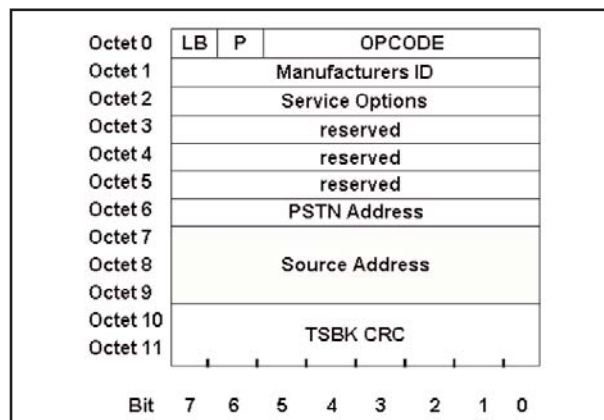

Figure 26: The PSTN Request Message

Once the dial or PSTN request has been received, the RFSS negotiates with the PSTN link to establish the call. Once the RFSS receives a response from the PSTN to continue, it issues a channel grant in the form of a TELE_INT_CH_GRANT message as show in Figure 27. Once the call is done, the SU can issue a cancel service request to terminate the call.

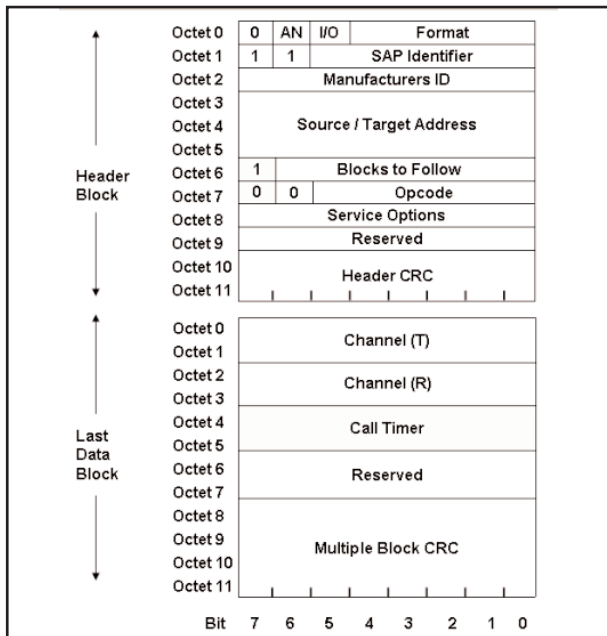

Figure 27: The TELE_INT_CH_GRANT Message

Testing P25 Trunking Radios in an Explicit mode

Since P25 Trunking systems utilize digital voice channels controlled by a digital control channel, we do not typically need to test the inbound control channel (ISP) for parametric performance. However, we do need to allow for setup and testing of the interaction between the control channel and the transition to the traffic channel. These tests are called protocol tests, in which we test the radio's ability to respond to commands from the radio test set.

In order to do this, the test system needs to be able to emulate some of the protocol (OSPs) that the repeater sends out. In addition, the system needs to be able to respond to the ISPs the mobile is sending and react appropriately to get the unit onto a traffic channel for proper parametric testing. While on the traffic channel, the test system also needs to keep in communication with the mobile with control messages that are "associated" or embedded with the voice call information. This is done through P25 specified LDU (logical data units) messages. These data units carry both voice and data information during a "call".

Being RF based, these systems also require the ability to test and verify parametric performance including frequency error, power, modulation accuracy and other parameters.

Using the 2975 to perform advanced P25 trunking tests

The 2975 provides powerful test features for P25 Trunked systems. These tests include the following:

1. The ability to emulate a P25 repeater station and initiate a system originated call. Either implicit or explicit. With the 2975, you are not locked into a specific test sequence for the radio. You decide what pass and fail means.
2. The ability to handle a P25 mobile initiated call. Either implicit or explicit.
3. The ability to perform full digital test functions.

The 2975 provides access to message elements and fields that other P25 testers do not allow. This gives the operator added flexibility in testing functionality, especially interoperability testing between mobiles and P25 networks.

P25 Trunking Control and Traffic Channel Setup

Setting up the control and traffic channel is the first thing that needs to be accomplished to begin testing P25 Trunked radios. This application note will show you how to enable the P25 Repeater Simulator for testing mobiles. In all test modes for P25 mobile systems, the instrument should be in the duplex mode. To enable the duplex mode, click on the screen selection button next to the time at the very upper left of the screen or select <MODE>, <3> as shown in Figure 28.

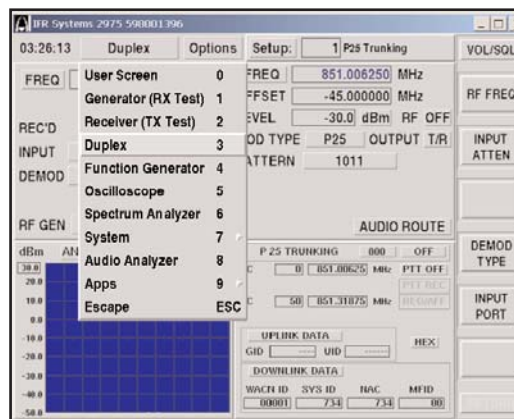

Figure 28: Selecting Duplex Mode

From there, we want to enable the Repeater Simulator. To do this, select the "Options" button next to the Duplex display at the top right of the display or select <SHIFT>,<MODE> and then select "P25 Repeater Sim". See Figure 29 for this selection. Note that we have also selected the Spectrum Analyzer for display.

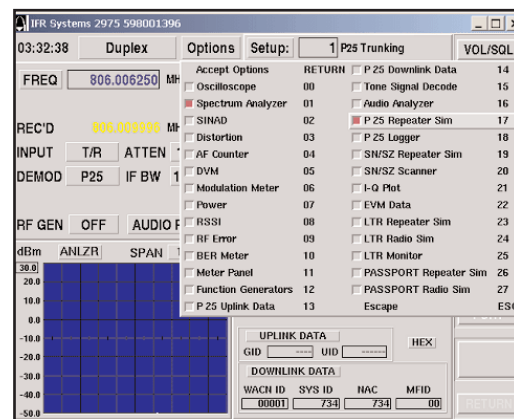

Figure 29: Selecting the P25 Repeater Simulator

To enable a valid control channel, we need to set up the proper control and traffic channel numbers. This is fairly straightforward for 800 MHz operation, in that the channels are defined with a set frequency assignment. The duplex offset is also standard at 45 MHz. We simply enter the proper channel number or frequency in the CC and VC data fields. See figure 30. Refer to the application note "Understanding 800 MHz and VHF/UHF Implicit P25 Control Channel Functions using the 2975" for more details.

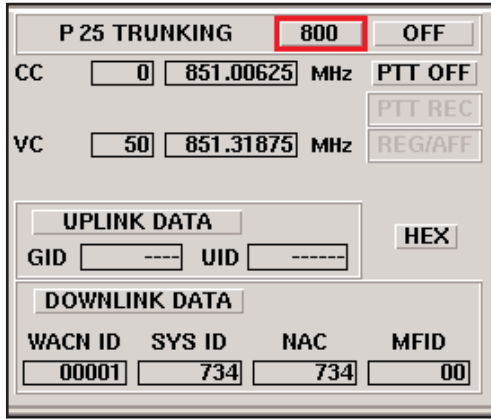

Figure 30: Setting-up the Control Channel and Voice (Traffic) Channel - 800 MHz band

For VHF/UHF implicit operation, things become a little more complex. You will note that upon selecting the U/V mode, an additional button named "CONFIG" pops up under the REG/AFF indicator section. See Figure 31 for more detail. The VHF/UHF/700MHz Other Band P25 Trunking Option (OPT 14) needs to be installed before being able to set up this feature.

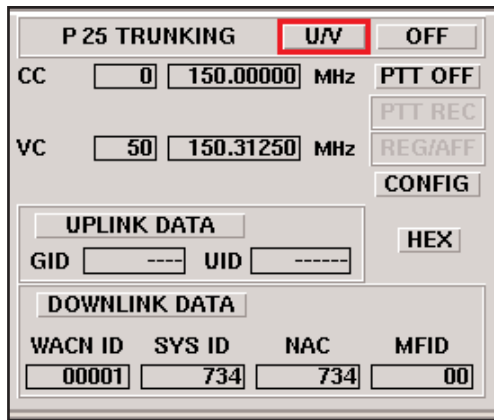

Figure 31: The VHF/UHF P25 Implicit Trunking Mode

Expanding the "CONFIG" button reveals in detail the Channel Identifier information we studied earlier in this application note. Figure 32 shows the configuration screen.

CHANNEL ID	BASE FREQUENCY (MHz)	BANDWIDTH (kHz)	TRANSMIT OFFSET (MHz)	CHANNEL SPACING (kHz)
0	136.000000	12.500	1.0000	6.250
1	150.000000	6.250	2.0000	6.250
2	150.000000	6.250	2.0000	6.250
3	150.000000	6.250	2.0000	6.250
4	150.000000	6.250	2.0000	6.250
5	150.000000	6.250	2.0000	6.250
6	150.000000	6.250	2.0000	6.250
7	150.000000	6.250	2.0000	6.250
8	150.000000	6.250	2.0000	6.250
9	150.000000	6.250	2.0000	6.250

Figure 32: The Configuration Screen for VHF/UHF mode of operation

As you can see, the configuration screen shows all the parameters associated with the IDEN_UP_VU messages. The Base Frequency, bandwidth, transmit offset and channel spacing are set equivalent to the IDEN_UP_VU information or the radio's internal programming. This is the same for either implicit or explicit set-up. The user needs to be very familiar with this feature in order for this table to be set up correctly. Note that the 2975 sends one IDEN_UP_VU message at any given time, but allows you to select multiple configurations for this message.

Setting Explicit Control Channel Protocol Elements

Now that we understand the control channel broadcast messages, the registration and group affiliation process and the various call sequences, we can move on with setting up the 2975 to perform not only parametric tests, but also protocol tests. We have the control and traffic channel setup, however, we need to set additional parameters before proceeding. For proper operation, we need to enter a valid WACN ID and System ID, which we've already reviewed. We also need to set the NAC.

The NAC is the Network Access Code that is an 8-bit field. With P25 trunking systems, the NAC is typically the same as the P25 System ID, although they may be configured differently to provide added flexibility for the network operator. Figure 33 shows how to set up the WACN ID, NAC, System ID and the MFID - Manufacturers ID (typically "00" for P25 compliant messages). Setting the WACN ID, NAC and System ID along with configuring the IDEN_UP_VU message, is the minimum configuration for testing the mobile unit.

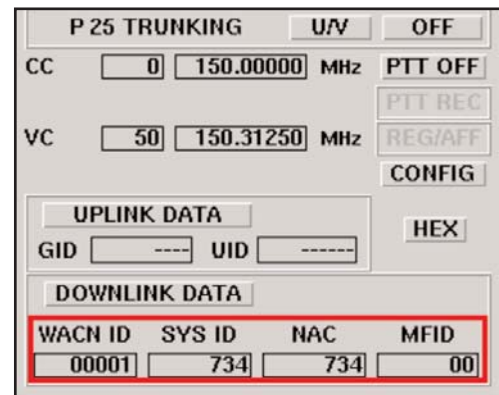

Figure 33: Setting the WACN ID, NAC, System ID and MFID

While the difference between the implicit and explicit mode of operation is extensive, the 2975 makes that difference almost transparent to the user. With Option 14, the VHF or UHF P25 trunked radio feature is enabled on the 2975 for the implicit mode of operation. By enabling Options 22 and/or 23, this feature now expands the 2975's VHF and UHF operation to include emulation of the multiple block message formats discussed earlier. Option 22 will enable the Group voice channel grant message, while option 23 will enable more extended call support, including the Unit to Unit and PSTN interconnect call capabilities. With the explicit mode of operation, the 2975 is sending an IDEN_UP_VU message as seen in Figure 4.

The main differences between implicit and explicit mode can best be seen when the "downlink data" button is selected in the VHF/UHF mode. See Figure 34 to see how to select the "downlink data" functions.

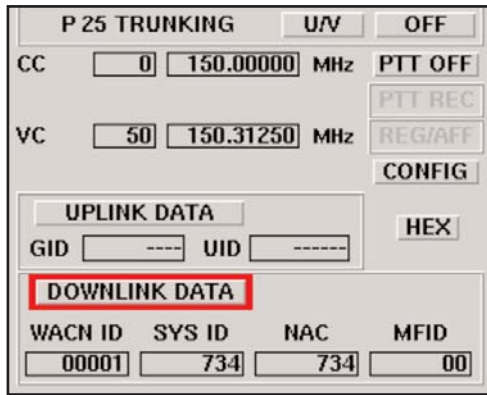

Figure 34: Selecting the Downlink Data Functions

Once selected, the user can select a variety of parameters associated with the OSP set up of the 2975. This includes the ability to control the various parameters included with the RFSS Status Broadcast and Network Status Broadcast messages as well as the Group Voice Channel Grant as was covered earlier in this application note. Figure 35 shows how to configure the 2975 for emulation of these parameters.

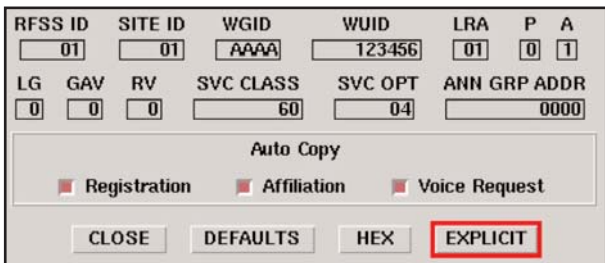

Figure 35 Setting the Various Downlink Parameters for Control Channel Emulation.

Notice that when the Explicit Mode (OPT22) of operation is enabled, the user is given the option to toggle between an implicit and explicit mode of operation. After selecting the Explicit Mode of operation and closing the downlink data box, we can observe the difference between the Implicit and Explicit mode of operation. Compare Figure 36 to Figure 31. You'll notice that the Control Channel and Voice Channel parameters now have the explicit TX and RX frequencies associated with the Explicit mode of operation. These TX and RX frequencies are based on the configuration data entered earlier (IDEN_UP_VU data). In addition, a new field appears to the left of the channel number and frequency fields. This is the channel identifier used to reference what channel combination was defined earlier.

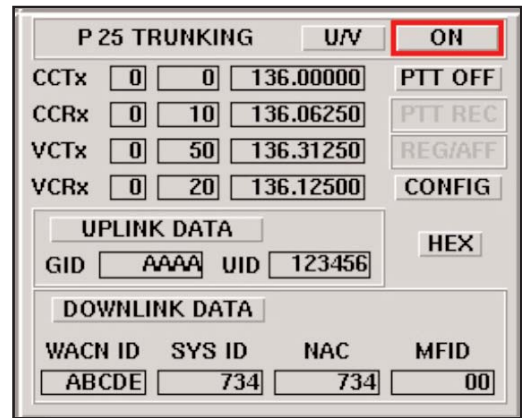

Figure 36: The Explicit Mode Control Channel and Voice Channel

Setting the specific TX and RX frequencies and enabling the Explicit Mode of operation are the only user operations that are required to switch the 2975 from an implicit mode to an explicit mode using multi-block messaging.

As you can see, there is also a feature area designated as the Auto-Copy area, see Figure 35. This area deals with the WUID and WGID issues discussed earlier. By enabling the auto-copy function, the user can have the 2975 echo back (copy) the SU's pre-programmed Unit ID (Registration) and/or the Group ID (Affiliation) by enabling the appropriate box (in red). Enabling the Voice Request means that during the Group Voice Channel Grant, the system will use the Group ID received from the SU instead of the WGID in the message parameters.

Disabling any of these functions means that the pre-programmed WGID and WUID would be used as needed. This can be programmed in the top line of the P25 Trunking Downlink Configuration screen.

Uplink Data Analysis

The 2975 will automatically decode a number of fields from the mobile when the unit registers and affiliates with the 2975. This feature can be very helpful in determining if the unit has been setup correctly for use on the network. On the primary P25 trunking tile, you will see the two indicators for the GID or Group ID used for initiating group calls, and the UID or Unit ID (Source ID). Only the 2975 provides this capability for testing P25 mobiles.

Now that we understand the fields in each of the messages used during a registration and affiliation process, and during a unit to group voice call, we can use the 2975 to decode these fields to assist in testing interoperability of various SU's and systems. Figure 37 shows the 2975's P25 Trunking Uplink Data Decode screen.



Figure 37: The P25 Trunking Uplink Configuration Decode Screen.

These fields are derived from the SU's U_REG_REQ and GRP_AFF_REQ messages sent during the registration and affiliation processes discussed earlier. These are not user definable fields.

Testing with the 2975 - Group Voice Channel Explicit Mode

We can now perform either a mobile originated call or a repeater originated call. To perform mobile radio transmitter tests, simply key the mobile unit and the 2975 will automatically assign the unit to the proper voice channel for performing parametric tests using the appropriate message format as selected by the implicit or explicit function.

Figure 38 shows the 2975 setup in the Duplex Mode with the P25 repeater simulator running in the VHF band and with a Spectrum Analyzer tile enabled to view the spectrum from the SU. Notice that the SU has registered with the 2975 as seen by the lit REG REC field.

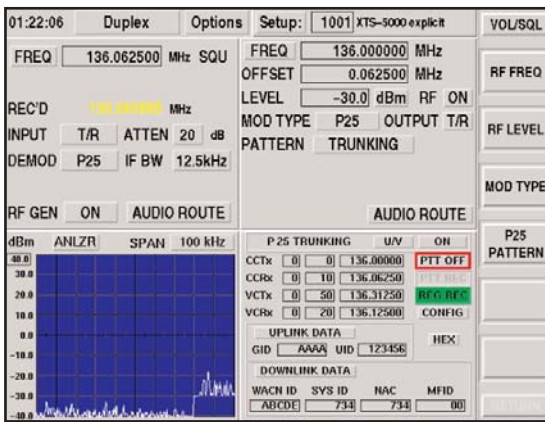

Figure 38: P25 Trunking Control Channel Screen with the Spectrum Analyzer Enabled Showing a Unit Registration Received from the SU

Figure 39 shows the Group Affiliation message received from the SU to the 2975

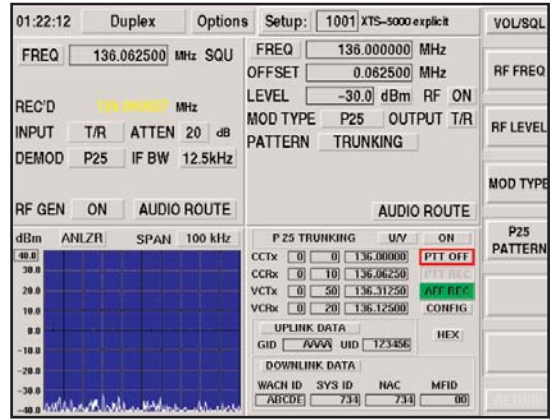

Figure 39: P25 Trunking Control Channel Screen with the Spectrum Analyzer Enabled Showing a Group Affiliation Received from the SU

Figure 40 shows the SU originating a call, as seen by the lit PTT REC (push to talk received) field on the P25 Trunking tile.

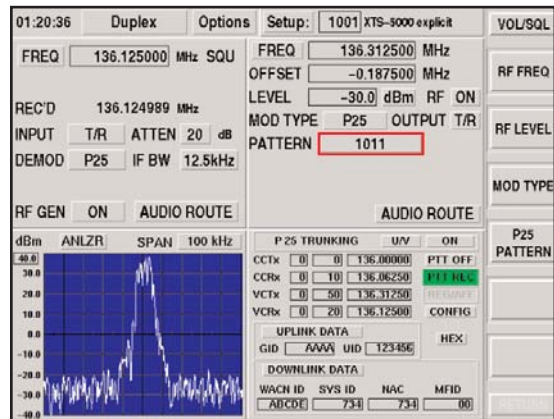

Figure 40: P25 Trunking Control Channel Screen with the Spectrum Analyzer Enabled Showing a SU Originated Call (PTT REC)

Note that the duplex receiver and generator frequencies have changed since the unit is now on the voice channel with the previously defined duplex offset as established in the P25 channel configuration table.

To enable a call from the 2975 to the SU, simply de-key the radio and select the PTT OFF button. This will toggle to a PTT ON mode and the 2975 will send a group voice channel grant message and then transmit the appropriate voice data as selected by the user (1011 tone, Speech, etc...) and keep the call active until the PTT ON is toggled to the PTT OFF mode.

With Option 22, the group voice mode is the only explicit mode operating, however, with Option 23 enabled, the user can also select unit to unit or PSTN interconnect modes.

Testing with the 2975 - Unit to Unit Explicit Mode

If the SU is originating a unit to unit call, the 2975 will automatically determine the type of call coming in and respond appropriately. For example, if a unit to unit call is received from the SU, the PTT REC field will automatically change to indicate that a unit to unit call request has been received. The 2975 then accept the call and send an UU_ANS_REQ to the radio and then a UU_V_CH_GRANT. See Figure 41 that shows a Unit to Unit Request Received.

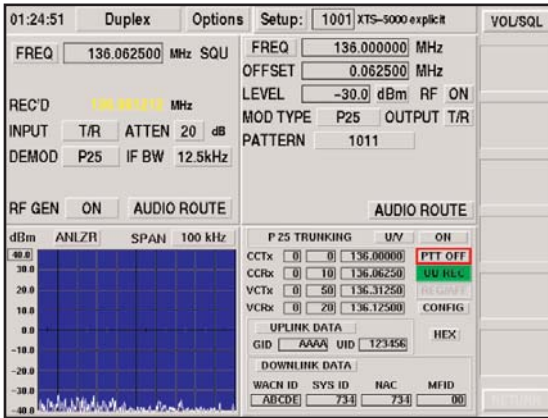

Figure 41: P25 Trunking Control Channel Screen with the Spectrum Analyzer Enabled Showing a SU Originated Unit to Unit Call (UU REC)

However, if the user wants to initiate a unit to unit call from the 2975 to the SU, then the 2975, when the PTT OFF button is selected (with Option 23 enabled only), will display the ability to initiate either a unit to unit call or PSTN call. See Figure 42.

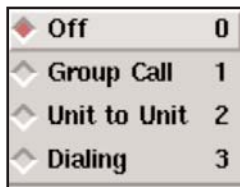

Figure 42: With Options 22 and 23 enabled, the 2975 Allows for Explicit Group, Unit to Unit and PSTN Calls

With the unit to unit call, the 2975 will send to the SU the UU_ANS_REQ message and then wait for the appropriate user interaction (that results in the generation of the UU_ANS_RSP message) to the 2975 that allows the call to be accepted. The 2975 will display the received response from the SU (Proceed, Deny or Wait) and display that on the PTT REC field of the trunking tile. See Figure 43.

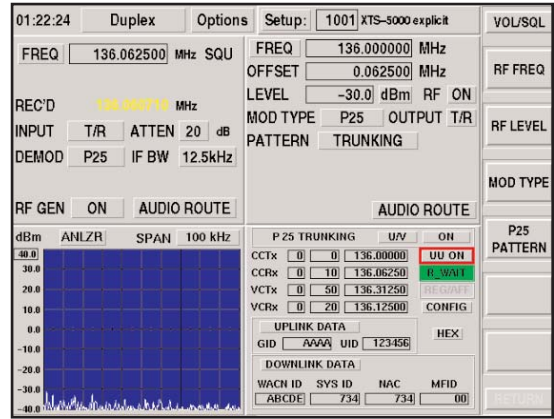

Figure 43: The 2975 Displaying the R WAIT State Received from the SU during a Unit to Unit Call

If a "Proceed" is received, the 2975 then finishes the communication with a UU_V_CH_GRANT message to complete the call with the appropriate user selected voice data. See Figure 44 and note the changed frequencies for the transmitter and receiver.

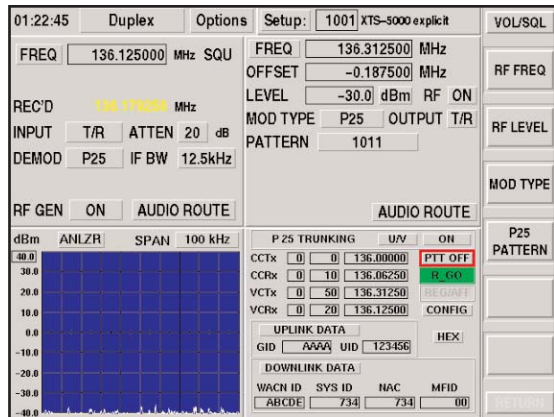

Figure 44: The 2975 Displaying the R GO (Proceed) State Received from the SU during a Unit to Unit Call

In addition to seeing the various call processes on the trunking tile, the 2975 allows the user to set various parameters being sent to the radio during the Unit to Unit call process. During the Unit to Unit call set up, the Source ID, Source Address and Target Address are sent to the target SU and then to both the target and source SU in the channel grant. The 2975 can individually set these parameters to emulate a specific user on a network. See Figure 45.

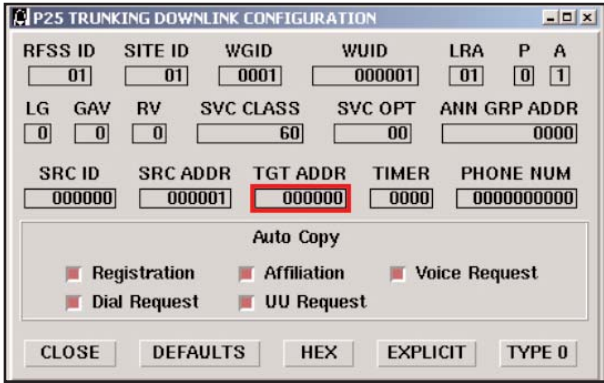

Figure 45: Configuring the Source ID, Source Address and Target Address in the 2975

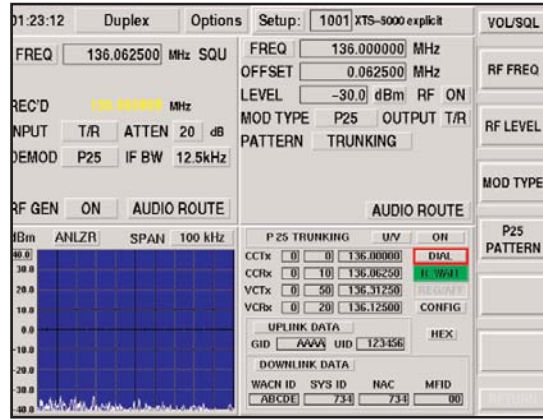

Figure 47: The 2975 Generating a PSTN Call to the SU

Testing with the 2975 - PSTN Explicit Mode

If the SU is originating a PSTN call, the 2975 will automatically determine the type of call coming in (either a TEL_INT_DIAL_REQ or TEL_INT_PSTN_REQ) and respond appropriately. The PTT REC field will automatically change to indicate that a PSTN call request has been received. The 2975 will then accept the call and send a TEL_INT_CH_GRANT to the radio. See Figure 46.

The PSTN mode allows the user to define the number that will be sent to the radio. This is important information, as the user can then test how the radio recovers that number and then display or optionally correlate that information to a user identifier (i.e. "Bob" calling). See Figure 48 to view the associated telephone number and timer information.



Figure 46: The 2975 Displaying the Dial Request Received from the SU during a PSTN Dial Call

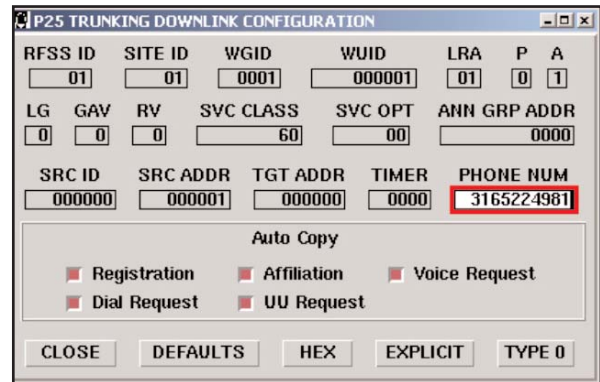

Figure 48: Setting-up the 2975 to Emulate the Dialing Number.

If the user wants to initiate a PSTN call from the 2975 to the SU, then the 2975, when the PTT OFF button is select (with Option 23 enabled only), will again display the ability to initiate either a unit to unit call or PSTN call (See Figure 41 above). The 2975 will then send a channel grant to the radio. See Figure 47.

Parametric Analysis

Besides the advanced protocol test capabilities, the 2975 has the ability to perform extensive parametric analysis.

Once we have the control channel set up and running, and the mobile is talking with the 2975, we can then select any number of options to run. This includes the Oscilloscope, Spectrum Analyzer, Meter Panel, Power Meter, RSSI Meter, etc.... To enable these functions, select the "Options" button or select <SHIFT>,<MODE> and select the combinations you wish. Remember that not all screens can be displayed at one time and you will be limited to two 1/4 tile "Meter" screens or one 1/2 tile Oscilloscope/Spectrum analyzer screen when run in conjunction with the P25 Control Channel simulator screen in the duplex mode. More screen modes can be defined in the user mode <MODE 0> or the receiver mode <MODE 2>.

The 2975 has every instrument constantly running in an operational state, and by simply changing modes, we change the "view" of the instrument. As seen in Figure 49, the 2975 receiver <MODE 2> shows the receive frequency, power meter, frequency error meter, modulation accuracy meter, and the traffic uplink decode information.

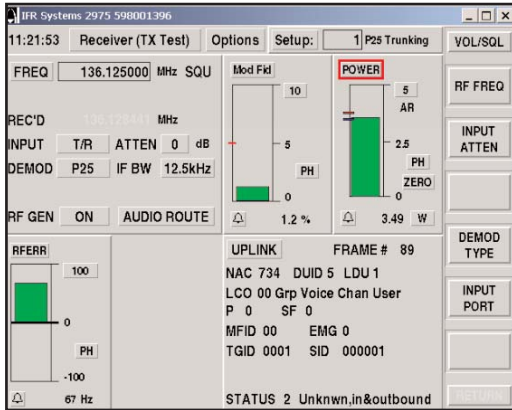

Figure 49: The Receiver (Transmitter Test) mode with Power, Frequency Error and Modulation Meters and the P25 Uplink Decode Tile

Notice that the meters display green bars. This is because prior to conducting the test, we set pre-determined pass/fail limits for each of the parameters. We know that the radio is within the range of performance for Power, RF Frequency Error and Modulation Error.

To perform mobile receiver measurements, enable the PTT mode by selecting the PTT button directly below the ON/OFF button on the repeater screen. This will cause a repeater originated call request to be sent to the mobile and the mobile will then be assigned to a voice channel in a "listen" (receive) mode.

We can now enable a unique sensitivity test called the "Speech" mode. The speech mode is a special voice file that provides a pre-recorded voice pattern that allows the test professional to quickly determine the receiver's sensitivity. This is accomplished by listening to the pre-recorded audio voice patterns and then reducing the RF level until the voice starts to break up or sounds slurred. This test is unique to the 2975 and is another way that Aeroflex is improving technician productivity. Figure 50 shows how to select the speech mode and Figure 51 shows where to adjust the RF level. Once you hit a level where the voice is breaking up, that become the receiver's "realistic" sensitivity. Tests have shown that this mode of testing typically correlates to a 5% BER test, commonly used for digital receiver testing, by a few dB.

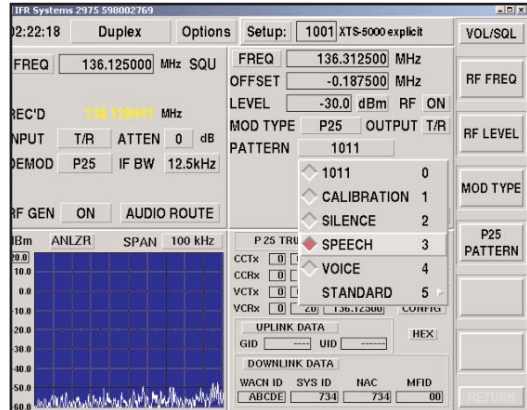

Figure 50: Setting the 2975 up for P25 Sensitivity Testing Using the Speech Mode.

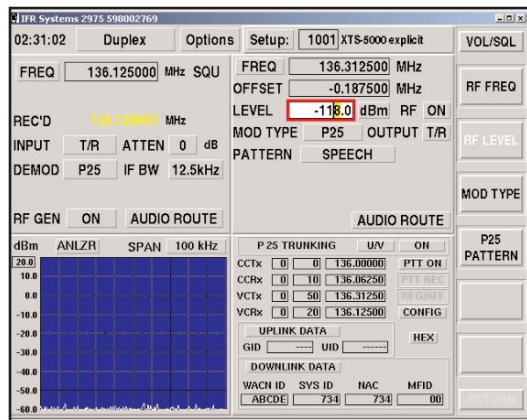

Figure 51: Decrease the RF Output until Speech Quality Degrades

Conclusion

The 2975 provides some of the most advanced testing functions ever presented in a communication test set. For testing P25 systems, the 2975 truly allows for dynamic testing by means of true repeater functionality. The 2975 provides the test professional with the most advanced wireless test set on the market for P25 and other PMR systems.

CHINA Beijing
Tel: [+86] (10) 6539 1166
Fax: [+86] (10) 6539 1778

CHINA Shanghai
Tel: [+86] (21) 5109 5128
Fax: [+86] (21) 5150 6112

FINLAND
Tel: [+358] (9) 2709 5541
Fax: [+358] (9) 804 2441

FRANCE
Tel: [+33] 1 60 79 96 00
Fax: [+33] 1 60 77 69 22

GERMANY
Tel: [+49] 8131 2926-0
Fax: [+49] 8131 2926-130

HONG KONG
Tel: [+852] 2832 7988
Fax: [+852] 2834 5364

INDIA
Tel: [+91] 80 5115 4501
Fax: [+91] 80 5115 4502

KOREA
Tel: [+82] (2) 3424 2719
Fax: [+82] (2) 3424 8620

SCANDINAVIA
Tel: [+45] 9614 0045
Fax: [+45] 9614 0047

SPAIN
Tel: [+34] (91) 640 11 34
Fax: [+34] (91) 640 06 40

UK Burnham
Tel: [+44] (0) 1628 604455
Fax: [+44] (0) 1628 662017

UK Cambridge
Tel: [+44] (0) 1763 262277
Fax: [+44] (0) 1763 285353

UK Stevenage
Tel: [+44] (0) 1438 742200
Fax: [+44] (0) 1438 727601
Freephone: 0800 282388

USA
Tel: [+1] (316) 522 4981
Fax: [+1] (316) 522 1360
Toll Free: 800 835 2352

As we are always seeking to improve our products, the information in this document gives only a general indication of the product capacity, performance and suitability, none of which shall form part of any contract. We reserve the right to make design changes without notice. All trademarks are acknowledged. Parent company Aeroflex, Inc. ©Aeroflex 2006.

www.aeroflex.com
info-test@eroflex.com



Our passion for performance is defined by three attributes represented by these three icons: solution-minded, performance-driven and customer-focused.

Part No. 46891/942, Issue 1, 08/06