

CellAdvisor JD780A Series

User's Manual

JD785A Base Station Analyzer

JD786A RF Analyzer

JD788A Signal Analyzer

CellAdvisor JD780A Series

User's Manual

JD785A Base Station Analyzer

JD786A RF Analyzer

JD788A Signal Analyzer



Network and Service Enablement
One Milestone Center Court
Germantown, Maryland 20876-7100 USA
Toll Free 1-855-ASK-JDSU • Tel +1-240-404-2999 • Fax +1-240-404-2195
www.jdsu.com

Notice

Every effort was made to ensure that the information in this manual was accurate at the time of release. However, information is subject to change without notice, and JDS Uniphase reserves the right to provide an addendum to this manual with information not available at the time that this manual was created.

Copyright

© Copyright 2014 JDS Uniphase Corporation. All rights reserved. JDSU, Network and Service Enablement, and its logo are trademarks of JDS Uniphase Corporation (“JDS Uniphase”). All other trademarks and registered trademarks are the property of their respective owners. No part of this document may be reproduced or transmitted electronically or otherwise without written permission of the publisher.

Copyright release

Reproduction and distribution of this document is authorized for Government purposes only.

Trademarks

JDSU and CellAdvisor are trademarks or registered trademarks of JDSU in the United States and/or other countries.

Google Maps and Google Earth are either trademarks or registered trademarks of Google in the United States and/or other countries.

Acknowledgement

This product incorporates open source software entitled “zlib”. The zlib is the compression library written by Jean-loup Gailly and Mark Adler, who granted permission to use this software for any purpose, including commercial applications.

This product includes open source software developed by the Apache Software Foundation (<http://www.apache.org/>).

This product used free library for JPEG image compression written and distributed by Independent JPEG Group or IJG (<http://www.ijg.org/>).

See “Viewing OSS license” on page 40 for more information.

Ordering information

This manual is a product of JDSU, issued as part of the JD780A Series analyzers. The catalog number for a published manual is JD780A362 - printed. The catalog number for an electronic manual on CD-ROM is JD780A361 - electronic.

Terms and conditions

Specifications, terms, and conditions are subject to change without notice. The

provision of hardware, services, and/or software is subject to JDSU's standard terms and conditions, available at www.jdsu.com/terms.

EMC directive compliance

This product was tested and conforms to the EMC Directive, 2004/108/EC and its amending directives for electromagnetic compatibility. Conformity with this directive is based upon compliance with the harmonized European standards: EN61326-1, CISPR11, EN61000-3-2, and EN61000-3-3. A copy of the Declaration of Conformity is provided upon your request.

Low voltage directive compliance

This product was tested and conforms to the Low Voltage Directive, 2006/95/EC and its amending directives. Conformity with this directive is based upon compliance with the harmonized European standard EN61010-1. A copy of the Declaration of Conformity is provided upon your request.

WEEE and battery directive compliance

JDSU has established processes in compliance with the Waste Electrical and Electronic Equipment (WEEE) Directive, 2002/96/EC, and the Battery Directive, 2006/66/EC.

This product, and the batteries used to power the product, should not be disposed of as unsorted municipal waste and should be collected separately and disposed of according to your national regulations. In the European Union, all equipment and batteries purchased from JDSU after 2005-08-13 can be returned for disposal at the end of its useful life. JDSU will ensure that all waste equipment and batteries returned are reused, recycled, or disposed of in an environmentally friendly manner, and in compliance with all applicable national and international waste legislation.

It is the responsibility of the equipment owner to return equipment and batteries to JDSU for appropriate disposal. If the equipment or battery was imported by a reseller whose name or logo is marked on the equipment or battery, then the owner should return the equipment or battery directly to the reseller. Instructions for returning waste equipment and batteries to JDSU can be found in the Environmental section of JDSU's web site at www.jdsu.com. If you have questions concerning disposal of your equipment or batteries, contact JDSU's WEEE Program Management team at WEEE.EMEA@jdsu.com.

Contents



About This Manual	17
Purpose and scope	18
Assumptions	18
Safety and compliance information	18
Safety consideration	18
Battery	18
Electrostatic discharge precautions (ESD)	19
Using 12 V DC automotive adapter	20
Conventions	20
Technical assistance	21
<hr/>	
JD780A Series Overview	22
About the JD780A series	23
Features and capabilities	23
Options	24
Specifications	24
AC power	24
Physical specifications	24
<hr/>	
Getting Started	25
Unpacking the JD780A series	26
Exploring the JD780A series	26
Front panel	27
Top panel	28
Installing battery pack	30
Starting up the JD780A series	31
Managing files	31
Using save	31
Using load	34
Using file manager	34
Configuring system	35
Setting frequency reference	35
Setting date and time	35
Setting language	36
Setting power on	36
Changing display mode	36
Setting sleep time	37
Adjusting LCD brightness	37
Adjusting volume	37
Upgrading firmware	37
Checking installed firmware version	38
Installing new firmware	38
Managing licenses	39
Checking options	39
Installing options	40
Loading temporary license	40
Viewing OSS license	40
Performing service diagnostic	41
Viewing system log	41
Running self-test	41
Performing factory reset	41
Re-aligning touch screen	42
Using system administration	42
Logging in	42
Changing password	42
Locking limit key	42
Modifying online help	43

Running IP test.....	43
Activating StrataSync	44
Establishing a connection to StrataSync.....	44
StrataSync status indicators	45
Setting communication	45
Configuring Ethernet.....	45
Setting for JDViewer and JDRemote.....	46
Setting USBTMC mode	46
Setting SCPI mode.....	47
Configuring LMF setting.....	47
Enabling Bluetooth connection	47
<hr/>	
Analyzing Measurement Results	48
Using marker.....	49
Using peak search.....	50
<hr/>	
Using Spectrum Analyzer	51
Introduction	52
Display overview	52
Connecting a cable.....	53
Selecting measurement mode	54
Configuring test parameters	54
Setting frequency.....	54
Setting amplitude.....	56
Setting bandwidth	58
Setting average	59
Setting sweep.....	59
Using RF source.....	61
Conducting spectrum measurements	61
Setting trace	62
Setting limit.....	63
Conducting RF measurements	64
Channel power	64
Occupied bandwidth	66
Spectrum emission mask (SEM).....	67
Adjacent channel power (ACP).....	69
Multi-ACP	71
Spurious emissions	73
AM/FM audio demodulation	75
Field strength meter.....	77
Route map.....	79
Dual spectrum	81
PIM detection (single and multiple carriers)	82
<hr/>	
Using Interference Analyzer	85
Introduction	86
Display overview	86
Connecting a cable.....	87
Selecting measurement mode	88
Configuring test parameters	88
Setting frequency.....	88
Setting amplitude.....	89
Setting bandwidth	91
Setting average	92
Setting sweep.....	92
Conducting spectrum measurements	94
Sound indicator.....	94
AM/FM audio demodulation	95
Interference ID.....	95
Conducting interference measurements	96
Spectrogram.....	96
Dual spectrogram	97
RSSI.....	98
Interference finder	100
Spectrum Replayer.....	102

Setting limit for interference analyzer.....	103
<hr/>	
Using GSM/GPRS/EDGE Signal Analyzer.....	105
Introduction	106
Display overview	106
Connecting a cable.....	107
Direct connection.....	107
Indirect connection	107
Over the air (OTA)	108
Selecting measurement mode	109
Configuring test parameters	109
Setting frequency.....	109
Setting amplitude.....	110
Setting average	112
Setting sweep mode	112
Setting trigger source.....	112
Conducting spectrum measurements	113
Setting measure setup.....	113
Setting trace	114
Conducting RF measurements.....	114
Channel power	114
Occupied bandwidth	115
Spectrum emission mask (SEM).....	116
Spurious emissions	117
Setting limit for RF tests.....	119
Conducting power vs. time measurements	120
Power vs. time (slot)	120
Power vs. time (frame).....	122
Conducting constellation measurements	123
Setting measure setup.....	123
Setting limit for constellation	124
Measurement example	124
Performing auto measurements	125
Setting limit for auto measure	125
Setting measure setup.....	125
Setting display	126
Conducting GSM OTA measurements.....	127
Channel scanner	127
Frequency scanner.....	128
Multipath profile	130
Modulation analyzer	131
<hr/>	
Using WCDMA/HSPA+ Signal Analyzer.....	133
Introduction	134
Display overview	134
Connecting a cable.....	135
Direct connection.....	135
Indirect connection	135
Over the air (OTA)	136
Selecting measurement mode	137
Configuring test parameters	137
Setting frequency.....	137
Setting amplitude.....	138
Setting average	140
Setting sweep mode	140
Setting trigger source.....	140
Setting external clock.....	141
Conducting spectrum measurements	142
Setting trace	142
Conducting RF measurements.....	143
Channel power	143
Occupied bandwidth	144
Spectrum emission mask (SEM).....	145
ACLR.....	146
Multi-ACLR	147

Spurious emissions	148
Setting limit for RF tests.....	150
Conducting modulation measurements.....	151
Constellation.....	151
Code domain power	152
Relative code domain power.....	155
Codogram.....	157
RCSI.....	159
CDP Table	161
Setting limit for modulation tests	162
Performing auto measurements	163
Setting limit for auto measure	163
Setting measure setup.....	164
Setting display	164
Performing power statistics CCDF measurement	165
Setting measure setup.....	165
Measurement example	166
Conducting WCDMA/HSPA+ OTA measurements	166
Channel scanner	166
Scramble scanner.....	168
Multipath profile	168
Code domain power	169
Route map.....	171
<hr/>	
Using LTE - FDD Signal Analyzer.....	175
Introduction	176
Display overview	177
Connecting a cable.....	177
Direct connection.....	177
Indirect connection	178
Over the air (OTA)	178
Selecting measurement mode	179
Configuring test parameters	180
Setting frequency.....	180
Setting amplitude.....	180
Setting average	182
Setting sweep mode	183
Setting trigger source.....	183
Setting external clock.....	183
Conducting spectrum measurements	184
Setting measure setup.....	184
Setting trace	185
Conducting RF measurements	186
Channel power	186
Occupied bandwidth	187
Spectrum emission mask (SEM).....	187
ACLR.....	189
Multi-ACLR	189
Spurious emissions	191
Setting limit for RF tests.....	193
Conducting power vs. time (frame) measurements	194
Setting measure setup.....	194
Measurement example	195
Conducting modulation measurements.....	195
Constellation.....	195
Data channel	197
Control channel	200
Subframe.....	203
Frame.....	206
Time alignment error.....	209
Data allocation map.....	210
Setting limit for modulation tests	213
Performing auto measurements	214
Conformance test	214
Maintenance test	216
Signal performance test.....	218

DAS test.....	219
Performing power statistics CCDF measurements.....	221
Setting measure setup.....	221
Measurement example.....	222
Performing carrier aggregation measurements.....	222
Setting measure setup.....	222
Setting display.....	223
Measurement example.....	224
Using marker.....	224
Conducting LTE - FDD OTA measurements.....	225
Channel scanner.....	225
ID scanner.....	227
Multipath profile.....	228
Control channel.....	229
Datagram.....	231
Route map.....	233
<hr/>	
Using LTE - TDD Signal Analyzer.....	238
Introduction.....	239
Display overview.....	240
Connecting a cable.....	240
Direct connection.....	240
Indirect connection.....	241
Over the air (OTA).....	241
Selecting measurement mode.....	242
Configuring test parameters.....	243
Setting frequency.....	243
Setting amplitude.....	243
Setting average.....	245
Setting sweep mode.....	246
Setting trigger source.....	246
Setting external clock.....	246
Conducting spectrum measurements.....	247
Setting measure setup.....	247
Setting trace.....	248
Conducting RF measurements.....	249
Channel power.....	249
Occupied bandwidth.....	250
Spectrum emission mask (SEM).....	251
ACLR.....	252
Multi-ACLR.....	253
Spurious emissions.....	255
Setting limit for RF tests.....	257
Conducting power vs. time measurements.....	258
Power vs. time (slot).....	258
Power vs. time (frame).....	260
Conducting modulation measurements.....	261
Constellation.....	261
Data channel.....	264
Control channel.....	267
Subframe.....	270
Time alignment error.....	273
Data allocation map.....	275
Setting limit for modulation tests.....	277
Performing auto measurements.....	279
Conformance test.....	279
Maintenance test.....	280
Signal performance test.....	283
DAS test.....	284
Performing power statistics CCDF measurements.....	286
Setting measure setup.....	286
Measurement example.....	287
Performing carrier aggregation measurements.....	287
Setting measure setup.....	287
Setting display.....	288
Measurement example.....	289

Using marker	289
Conducting LTE - TDD OTA measurements	290
Channel scanner	290
ID scanner	292
Multipath profile	293
Control channel	294
Datagram	296
Route map	298
<hr/>	
Using CDMA Signal Analyzer	303
Introduction	304
Display overview	305
Connecting a cable	305
Direct connection	305
Indirect connection	306
Over the air (OTA)	306
Selecting measurement mode	307
Configuring test parameters	307
Setting frequency	307
Setting amplitude	308
Setting average	310
Setting sweep mode	310
Setting trigger source	311
Setting external clock	311
Conducting spectrum measurements	312
Setting trace	313
Conducting RF measurements	314
Channel power	314
Occupied bandwidth	315
Spectrum emission mask (SEM)	315
ACPR	316
Multi-ACPR	317
Spurious emissions	318
Setting limit for RF tests	320
Conducting modulation measurements	321
Constellation	321
Code domain power	322
Codogram	324
RCSI	325
CDP Table	327
Setting limit for modulation tests	328
Performing auto measurements	329
Setting limit for auto measure	329
Setting measure setup	330
Setting display	330
Performing power statistics CCDF measurements	331
Setting measure setup	331
Measurement example	332
Conducting CDMA OTA measurements	332
Channel scanner	332
PN scanner	334
Multipath profile	335
Code domain power	336
Route map	338
<hr/>	
Using EV-DO Signal Analyzer	342
Introduction	343
Display overview	343
Connecting a cable	344
Direct connection	344
Indirect connection	344
Over the air (OTA)	345
Selecting measurement mode	346
Configuring test parameters	346
Setting frequency	346

Setting amplitude.....	347
Setting average	349
Setting sweep mode	349
Setting trigger source.....	350
Setting external clock.....	350
Conducting spectrum measurements	351
Setting trace	351
Conducting RF measurements	352
Channel power	352
Occupied bandwidth	353
Spectrum emission mask (SEM).....	354
ACPR	354
Multi-ACPR.....	355
Spurious emissions	356
Setting limit for RF tests.....	358
Conducting power vs. time measurements	359
Power vs. time (idle slot).....	359
Power vs. time (active slot).....	359
Setting limit for power vs. time tests.....	360
Conducting modulation measurements.....	361
Constellation.....	361
Code domain power	364
MAC Codogram.....	366
RCSI.....	368
MAC CDP Table	369
Setting limit for modulation tests	370
Performing auto measurements	371
Setting limit for auto measure	371
Setting measure setup.....	371
Setting display	372
Performing power statistics CCDF measurements.....	373
Setting measure setup.....	373
Measurement example	373
Conducting EV-DO OTA measurements	374
Channel scanner	374
PN scanner.....	376
Multipath profile	377
Code domain power	378
Route map.....	380
<hr/>	
Using TD-SCDMA Signal Analyzer.....	383
Introduction	384
Display overview	385
Connecting a cable.....	385
Direct connection.....	385
Indirect connection	386
Over the air (OTA)	386
Selecting measurement mode	387
Configuring test parameters	387
Setting frequency.....	387
Setting amplitude.....	388
Setting average	390
Setting sweep mode	391
Setting trigger source.....	391
Setting external clock.....	391
Conducting spectrum measurements	392
Setting measure setup.....	392
Setting trace	393
Conducting RF measurements	394
Channel power	394
Occupied bandwidth	395
Spectrum emission mask (SEM).....	396
ACLR.....	397
Multi-ACLR	398
Spurious emissions	399
Setting limit for RF tests.....	401

Conducting power vs. time measurements	402
Power vs. time (slot)	402
Power vs. time (frame).....	403
Power vs. time (mask)	405
Timogram	406
Setting limit for power vs. time tests.....	408
Conducting modulation measurements.....	408
Constellation.....	408
Midamble power	410
Code power	411
Code error	413
Setting limit for modulation tests	414
Performing auto measurements	414
Conducting TD-SCDMA OTA measurements.....	416
Sync-DL ID scanner.....	416
Sync-DL ID vs. Tau	417
Sync-DL ID multipath.....	418
Sync-DL ID analyzer.....	419
Route map.....	420
<hr/>	
Using Mobile WiMAX Signal Analyzer	423
Introduction	424
Display overview	424
Connecting a cable.....	425
Direct connection.....	425
Indirect connection	425
Over the air (OTA)	426
Selecting measurement mode.....	427
Configuring test parameters	427
Setting frequency.....	427
Setting amplitude.....	428
Setting average	430
Setting sweep mode	430
Setting trigger source.....	431
Setting external clock.....	431
Conducting spectrum measurements	432
Setting measure setup.....	432
Setting trace	433
Conducting RF measurements	434
Channel power	434
Occupied bandwidth	435
Spectrum emission mask (SEM).....	437
Spurious emissions	438
Setting limit for RF tests.....	440
Conducting power vs. time (frame) measurements.....	441
Setting measure setup.....	441
Setting limit for power vs. time tests.....	442
Measurement example	442
Conducting modulation measurements.....	443
Constellation.....	443
Spectral flatness	444
EVM vs. subcarrier	446
EVM vs. symbol.....	448
Setting limit for modulation tests	450
Performing auto measurements	451
Performing power statistics CCDF measurements.....	452
Setting measure setup.....	453
Measurement example	453
Conducting Mobile WiMAX OTA measurements	453
Preamble scanner	453
Multipath profile	455
Preamble power trend	456
Route map.....	458
<hr/>	
Using Cable and Antenna Analyzer	461

Introduction	462
Display overview	462
Selecting measurement mode	463
Configuring test parameters	463
Setting frequency.....	463
Setting distance	464
Adjusting scale	465
Setting sweep mode	465
Performing calibration.....	465
1-port calibration.....	466
2-port calibration.....	467
Calibration status indicators.....	468
Connecting a cable.....	469
Connecting a cable for reflection, DTF, 1-port phase, and Smith Chart measurements	469
Connecting a cable for cable loss (1 port) measurements.....	470
Connecting a cable for 2-port vector measurements	470
Connecting a cable for 2-port scalar measurements	471
Performing reflection measurements	471
Making a measurement	472
Measurement example	473
Performing DTF measurements	473
Making a measurement	473
Measurement example	475
Performing reflection-DTF measurements	476
Making a measurement	476
Measurement example	476
Performing cable loss (1 port) measurements	477
Making a measurement	477
Measurement example	478
Performing 1-port phase measurements.....	479
Making a measurement	479
Measurement example	480
Performing Smith chart measurements.....	480
Making a measurement	481
Performing 2-port vector measurements.....	481
Making a measurement	481
Measurement example	482
Performing 2-port scalar measurements.....	483
Making a measurement	483
Measurement example	483
Analyzing measurements	484
Setting trace and display	484
Setting zoom zones.....	484
Setting alternate sweep	485
Setting limit for cable and antenna analyzer.....	486
<hr/>	
Using E1 Analyzer	487
Introduction	488
Display overview	488
Connecting a cable.....	489
Out-of-service testing.....	489
In-service monitoring	489
Monitoring transmission.....	490
Making a test.....	490
Measurement example	491
Performing BERT testing.....	491
Making a test.....	491
Measurement example	493
<hr/>	
Using T1 Analyzer	494
Introduction	495
Display overview	495
Connecting a cable.....	496
Out-of-service testing.....	496
In-service monitoring	496

Monitoring transmission.....	497
Making a test.....	497
Measurement example.....	498
Performing BERT testing.....	498
Making a test.....	498
Measurement example.....	500
Performing RX signal testing.....	500
Making a test.....	500
Measurement example.....	501
Performing loop testing.....	502
Making a test.....	502
Measurement example.....	504
<hr/>	
Using Channel Scanner.....	505
Introduction.....	506
Display overview.....	506
Connecting a cable.....	506
Direct connection.....	506
Indirect connection.....	507
Over the air (OTA).....	507
Selecting measurement mode.....	508
Configuring test parameters.....	508
Setting frequency.....	508
Setting amplitude.....	508
Setting average.....	510
Setting sweep mode.....	510
Making channel scanner measurements.....	511
Setting channel.....	511
Measurement example.....	511
Making frequency scanner measurements.....	512
Setting frequency.....	512
Measurement example.....	513
Making custom scanner measurements.....	513
Setting channel/frequency.....	513
Measurement example.....	515
Analyzing measurements.....	515
Setting limit for channel scanner.....	515
<hr/>	
Using Power Meter.....	518
Introduction.....	519
Display overview.....	519
Performing internal RF power measurements.....	519
Connecting a cable.....	520
Selecting measurement mode.....	521
Setting frequency.....	521
Setting amplitude.....	522
Setting sweep mode.....	523
Making a measurement.....	523
Measurement example.....	524
Performing external RF power measurements.....	524
Connecting a cable.....	524
Selecting measurement mode.....	525
Setting frequency.....	526
Setting amplitude.....	526
Making a measurement.....	526
Measurement example.....	527
Performing optical power measurements.....	527
Connecting a cable.....	527
Selecting measurement mode.....	528
Setting amplitude.....	528
Making a measurement.....	529
Measurement example.....	529
Setting limit for power meter.....	530
<hr/>	
Performing Fiber Inspection.....	531

Introduction	532
Display overview	532
Connecting a fiber microscope	532
Selecting measurement mode	533
Configuring test parameters	533
Selecting profile and tip	533
Setting preferences	533
Performing fiber inspection	534
Capturing fiber image	534
Measurement example	535
Testing a fiber	535
Measurement example	536
<hr/>	
Appendix	537
Appendix A – Product general information	538
Appendix B – Cable list	540
Appendix C – Band, frequency & channel standard	541
Appendix D – VSWR-Return loss conversion table	544
Appendix E – Cyclic prefix table	545
Appendix F – Motorola CDMA/EV-DO LMF	546
Using JD780A series LMF interface	546
Setting up for a LMF test	546
Performing a LMF test	547
Appendix G – Bluetooth connection	548
Installing and Setting up Bluetooth software	548
Making Bluetooth connection	548
Setting up communication in application	549
Turning Bluetooth mode on/off manually	550
Appendix H – Device driver installation	551
Appendix I – Ordering information	552
JD785A Base Station Analyzer	552
JD786A RF Analyzer	553
JD788A Signal Analyzer	554
JD780A Series Common Options	555
Appendix J – RoHS information	557
Appendix K – On-screen keyboard	558
Adding or deleting letters	558
Editing or adding a custom keyword	558
Appending a keyword	559

About This Manual

Topics discussed in this chapter include the following:

- Purpose and scope 18
- Assumptions 18
- Safety and compliance information 18
- Conventions 20
- Technical assistance 21

Purpose and scope

The purpose of this manual is to help you successfully operate the JD780A series and use its features and capabilities. This manual includes instructions that describe how to operate, set up, configure, and use the JD780A series, consisting of JD785A Base Station Analyzer, JD786A RF Analyzer, and JD788A Signal Analyzer.

Assumptions

This manual is intended for novice, intermediate, and experienced users who want to use the JD780A series effectively and efficiently. We are assuming that you have basic operation experience and are familiar with basic mobile communication concepts and terminology.



Safety and compliance information

Safety and compliance information for the instrument are provided upon your request.

Safety consideration

It is mandatory to permanently connect this product to the protective earth.

When powering this instrument externally, always use an AC power cable that includes an earth (safety) ground connection, which is shipped with your instrument.

	<p>WARNING Do not attempt to service this product yourself, as opening or removing covers may expose you to dangerous voltage and other hazards. Refer all servicing to qualified JDSU service personnel.</p>
	<p>CAUTION This equipment contains parts and assemblies sensitive to electrostatic discharge (ESD). Use ESD precautionary procedures when touching, removing, or inserting ESD sensitive parts and assemblies, or damage to components could result.</p> <p>An electrostatic-sensitive device can only withstand voltage spikes of 10 to 100 volts. Any discharge greater than this can damage or effectively destroy such a device while going unnoticed by a technician. Common plastics (synthetic insulating materials), clothing, and paper or cardboard are the most common source of static charges.</p>
	<p>CAUTION This instrument uses a Lithium Ion battery that, if not connected correctly, may lead to explosion. In case the battery needs to be exchanged, it must be the same kind as or compatible with the one shipped with your instrument.</p> <p>The battery must not be disposed of in a landfill site or as municipal waste, and should be disposed of according to your national regulations.</p>

Battery

The battery pack that comes with the instrument is Lithium Ion and it may lead to explosion if not connected correctly. In case the battery needs to be replaced, it must be one of the same kinds or compatible ones. Disposal of the batteries must be done according to local safety and environmental regulations.

Safety guide

- Do not expose the battery to high temperature such as fire, heat, direct sun, etc.
- Do not connect the positive and negative terminals of the battery together with any metal objects such as wires, paper clips, etc.
- Do not expose the battery to any type of liquid such as rain, water and salt water, etc.
- Do not disassemble or modify the battery.

Storage guide

Lithium Ion batteries continue to slowly discharge (self-discharge) when stored or not in use for a while. In this case, you need to:

- Remove the battery pack and store it separately from the product in a cool and dry location without direct sun light on the pack or its carton box.
- Store the battery at temperatures between 10 °C and 30 °C (50 °F and 86 °F) to minimize the deactivation effect of the battery.
- Storage at the temperatures above 30 °C or 86 °F reduces the battery storage life.
- Charge at least once per 6 months to prevent leakage and deterioration in performance caused by self-discharging.

Battery charge status indicator

You can find the indicator for battery charge status on the battery pack.



Table 1 Battery charge status

Indicator	Description
	Voltage < 9.0 V, immediate charge required
	Remaining Capacity Alarm, immediate charge required
	1 to 19% Remaining, charge before storage
	21 to 40% Remaining, charge before storage
	41 to 60% Remaining, charge before storage
	61 to 80% Remaining
	81 to 100% Remaining

Electrostatic discharge precautions (ESD)

This instrument was manufactured in an ESD protected environment. Semiconductor devices used in this product are susceptible to damage by static discharge. Depending on the magnitude of the discharge, semiconductor devices may be damaged by direct contact or mere proximity of a static charge. This may cause performance degradation, early failure, or immediate destruction. Use the following guidelines to prevent ESD damage:

- Before connecting a cable to this instrument terminal, short circuit the center of the cable with an outside metal shield.

- Before removing a connected cable or getting in contact with the center pin, wear a wrist strap with one MΩ resistor connected to the ground.
- All equipment must be connected to the ground to avoid accumulation of static charges.

Using 12 V DC automotive adapter

When powering or charging this instrument with the 12 V DC Automotive Adapter, always verify that the supply is rated for a minimum of 60 Watts @12 V DC and that the socket is clear of any dirt or debris. If the adapter plug gets hot to touch during operation, discontinue the use immediately.

Conventions

This document uses typographical and symbols conventions as described in the following tables.

Table 2 Text formatting and other typographical conventions

Item	Text formatting/symbols used	Example(s)
Buttons or hard keys that the user presses on a physical device	Bold, all caps, default font	Press the ON button. Press the MODE hard key. Press the MARKER hard key.
Hot keys that the user presses on a physical device	Bold, all caps, italics, default font	Press the <i>SYSTEM</i> hot key. Press the <i>MEASURE</i> hot key.
Soft keys or toggle keys that the user presses on a physical device to select corresponding menus	Bold, default font	Press the Span soft key. Press the Channel Power soft key.
Soft key option separators	Denoted by a vertical bar that means “or”, only one option can be selected with a single press	Press the Zone [1 2 3] soft key.
File type	Courier New	In . t r a file type.
Required arguments (text variables in code)	Denoted by slanted brackets < >.	Enter <password>

Table 3 Symbol conventions



This symbol represents a general hazard. It may be associated with either a DANGER, WARNING, or CAUTION message.



This symbol represents hazardous voltages. It may be associated with either a DANGER, WARNING, or CAUTION message.



This symbol represents a risk of explosion. It may be associated with either a DANGER, WARNING, or CAUTION message.



This symbol, located on the equipment, battery, or the packaging indicates that the equipment or battery must not be disposed of in a landfill site or as municipal waste, and should be disposed of according to your national regulations.

Table 4 Safety definitions

DANGER	Indicates a potentially hazardous situation that, if not avoided, <i>will</i> result in death or serious injury. It may be associated with either a general hazard, high voltage, or risk of explosion symbol.
WARNING	Indicates a potentially hazardous situation that, if not avoided, <i>could</i> result in death or serious injury. It may be associated with either a general hazard, high voltage, or risk of explosion symbol.
CAUTION	Indicates a potentially hazardous situation that, if not avoided, <i>could</i> result in minor or moderate injury and/or damage to equipment. It may be associated with either a general hazard, high voltage, or risk of explosion symbol. When applied to software actions, indicates a situation that, if not avoided, <i>could</i> result in loss of data or a disruption of software operation.

Technical assistance

Contact information for technical assistance is listed in the following table. For the latest TAC information, go to www.jdsu.com or contact your local sales office for assistance. Contact information for regional sales headquarters is listed on the back cover of this manual.

Table 5 Technical assistance centers

Region	Phone Number	E-mail Address
Americas	1-855-ASK-JDSU (option #3) (1-855-275-5378, option #3)	catvsupport@jdsu.com
Europe, Africa, and Mid-East	+49 (0) 7121 86 1345 (JDSU Germany)	hotline.europe@jdsu.com
Asia and the Pacific	China 400 122 6542 Taiwan 008 06651950 India 1800 103 5378 Australia 1800 095 127 New Zealand 0800 448 482 Japan 005 316 50533 Korea 007 986 517 490 Singapore 1800 223 7070 Malaysia 1800 806584 Thailand 1800 658177 Vietnam 12065180 Philippines 1800 16510736 Indonesia 001 803657082	tac.apac@jdsu.com

During off-hours, you can request assistance by doing one of the following: leave a voice mail message at the Technical Assistance number, e-mail the North American Technical Assistance Center, tac@jdsu.com, or submit your question using our online Technical Assistance Request form at www.jdsu.com.

JD780A Series Overview

This chapter provides a general description of the JD780A series. Topics discussed in this chapter include the following:

- About the JD780A series23
- Features and capabilities.....23
- Options24
- Specifications.....24

About the JD780A series



JDSU wireless RF test solutions for the field include base station analyzers, cable and antenna analyzers, and signaling analyzers for the installation and maintenance of modern wireless communication systems. RF test is critical for wireless operators facing challenges of signal quality and signaling interference, and maintaining quality high-bandwidth services.

The JD780A series addresses spectrum analysis, interference analysis, and cable, antenna and modulation analysis, covering current wideband technologies such as WiMAX and LTE.

Base station analyzer JD785A

The Base Station Analyzer contains all the features and capabilities required to perform field testing of cell sites of all wireless technologies, from 2G to 4G.

RF analyzer JD786A

The RF Analyzer provides multi-purpose solution for the analysis of RF systems covering all physical aspects of transmission, reception, and interference of RF systems up to 8 GHz.

Signal analyzer JD788A

The Signal Analyzer contains all the features and capabilities required to perform cell site field testing for all wireless technologies from 2G to 4G.

Features and capabilities

The JD780A series is the optimal test solution for installation and maintenance of cellular base stations and cell sites, running with external AC power or battery for the field.

The user interface has been specifically designed with customized menus and simple calibration procedures, providing service providers with accurate and reliable measurement results.

Applicable Systems

- cdmaOne/cdma2000
- EV-DO
- WCDMA/HSPA+
- GSM/GPRS/EDGE
- TD-SCDMA
- WiMAX
- LTE/LTE-Advanced (FDD/TDD)

Key Features

Table 6 Key functions

Functionality	JD785A	JD786A	JD788A
Spectrum Analyzer	■	■	■
Cable and Antenna Analyzer	■	■	
RF Power Meter	■	■	■
Optical Power Meter	■	■	■
Fiber Inspection	■	■	■
Signal Analyzers (optional)	■		■
E1/T1 Analyzers (optional)	■		
Interference Analyzer (optional)	■	■	■
Channel Scanner (optional)	■	■	■
OTA Measurement (optional)	■		■

Options

This instrument is provided with various options/features that are available to be ordered. See “Appendix I – Ordering information” on page 552 for more information.

Specifications

AC power

Input voltage is automatically selected within the instrument’s tolerable input line voltage from 100 to 240 VAC. This instrument does not have a separate line protection fuse.

Table 7 AC power requirements

Item	Specification
AC Power	100 to 240 V AC, 50-60 Hz
Power Consumption	37 W in operation; 49 W with battery charging

Physical specifications

Table 8 shows weight with standard configurations and the battery pack installed.

Table 8 Physical specifications

Parameter	JD785A/JD786A	JD788A
Height	7.7" (195 mm)	7.7" (195 mm)
Width	11.6" (295 mm)	11.6" (295 mm)
Depth	3.2" (82 mm)	3.2" (82 mm)

Getting Started

This chapter provides general guides of how to get started with your JD780A series instrument. Topics discussed in this chapter are as follows:

■ Unpacking the JD780A series	26
■ Exploring the JD780A series	26
■ Installing battery pack	30
■ Starting up the JD780A series	31
■ Managing files.....	31
■ Configuring system	35
■ Upgrading firmware	37
■ Managing licenses	39
■ Performing service diagnostic	41
■ Using system administration.....	42
■ Running IP test	43
■ Activating StrataSync	44
■ Setting communication	45

Unpacking the JD780A series

Unpack and inspect the shipping package thoroughly to ensure that nothing was damaged during the shipment. Also, check that your delivered package includes all of your ordered items in the shipment. If contents in the package are damaged or defective or if there are any missing items, keep the shipping list and materials for carrier’s inspection and contact your nearest JDSU’s authorized sales and service office.

A basic test set of JD780A series would include the following items in the package. For more options, see “Appendix I – Ordering information” on page 552.

Table 9 Items included in a basic test set shipment

Item	Quantity
JD780A series instrument (JD785A, JD786A, or JD788A)	1
AC/DC power adapter and power cord	1
1.5 meter cross LAN cable	1
1.8 meter USB A-to-B cable	1
> 1 G byte USB memory	1
Rechargeable Lithium Ion battery pack	1
12 V DC automotive adapter	1
Stylus Pen	1
User’s manual and application software CD	1

Exploring the JD780A series

Figure 1 JD785A front panel view



Front panel







The JD780A series analyzers have the same front panel look as like Figure 1, except for the bumpers in different colors.

Power on/off button

Key	Description
	POWER ON/OFF – You can turn your instrument on or off. Two LEDs indicate power source and status. See “Starting up the JD780A series” on page 31.







Function hard keys





You can use these hard keys to activate specified functions as labeled on each key.

Key	Description
	MODE – You can select an analyzer mode from all the standard and optional modes available to your instrument.
	FREQ/DIST – You can configure frequency or distance settings.
	AMP/SCALE – You can configure amplitude and scale settings.
	BW/AVG – You can configure bandwidth and average settings.
	TRACE/DISPLAY – You can set up trace and display parameters.
	MARKER – You can analyze measurements with markers.
	PEAK SEARCH – You can set up peak search parameters.

Hot keys

When the user input field on the screen is inactive, you can use these hot keys to activate specific functions instead of numbers. When you see the user input field activated or highlighted, press the **ESC** hard key to use these hot keys.







Key	Description
	MEASURE – You can select measurements available for your selected analyzer mode.
	MEASURE SETUP – You can set measurement parameters available for your selected measurement mode.
	SAVE/LOAD – You can save or load your current screen, result, setup, or limit into or from the internal memory or an external USB memory drive.
	SWEEP – You can configure sweep parameters.
	TRIGGER – You can select trigger options such as internal, external, and GPS.
	SYSTEM – You can configure your system settings or view your current system information.

	PRESET – You can use this key to return to a known state and make measurements.
	HOLD – You can change the sweep mode: Continue or Single.
	LIMIT – You can set limit settings such as display line, multi segment line, save limits, recall limits, or test specification limits.
	BACKLIGHT – You can turn the key backlight feature on or off.
	HELP – You can have the online help screen on.

Soft keys

You can use these soft keys along the right side of the display to start a specific function associated with each key, invoke other screen keys, or select a unit. The **More** screen menu indicates that there are more than seven screen menus for the level. The small arrowhead symbol in the screen menu indicates that there are screen menus under the screen menu.

Data entry and other keys

Key	Description
	ROTARY KNOB WITH ENTER KEY – You can change a value with predefined increments or move marker position. Rotating this knob clockwise increases value or moves a marker to the right and rotating counter clockwise does vice versa. This knob works as the ENTER hard key as well.
	ARROW KEYS – You can increase or decrease value or move your selection up, down, to the left, or to the right.
	NUMERIC KEYS – You can manually enter a value for measurement parameters.
	DEL – You can delete data entry. After pressing the ENTER key or selecting a unit soft key, you cannot delete or remove data entered.
	ENTER – You can save and confirm data entry.
	ESC – You can cancel any input in the user input field or dismiss a pop-up window on the screen.
	PREV – You can go back to the previous menu without changing current setup.

Top panel

The JD785A and the JD786A analyzers have the same top panel view as Figure 2, except for the E1/T1 inlet. The JD786A has the GPIO inlet instead.

Figure 2 JD785A top panel view

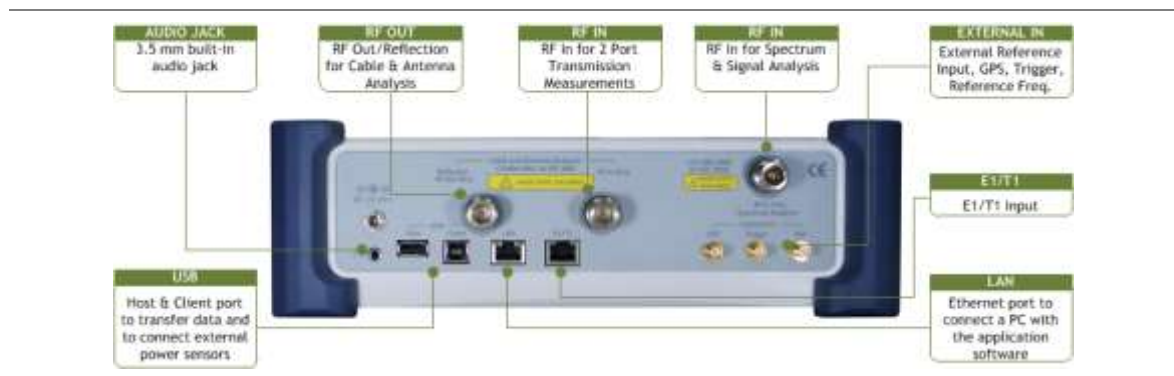

Reflection/RF Out (Cable and Antenna Analyzer)

The **Reflection/RF Out** port of the Cable and Antenna Analyzer is a precise 50 Ω N-type female connector that is used as the output signal port for the Cable and Antenna Analyzer mode.



CAUTION

Do not apply or connect power exceeding +25 dBm to this Reflection/RF Out port. If such power is applied, it will degrade the product's performance and can cause damage to the product in worst case.

RF In (Cable and Antenna Analyzer)

The **RF In** port is a precise 50 Ω N-type female connector that is used as the input signal port for insertion gain/loss measurements in the Cable and Antenna Analyzer mode.



CAUTION

The maximum power allowed to the RF In port is +25 dBm. If the input power exceeds the limit, it may degrade the product performance or cause damage to the instrument in a worst case. Do not connect any power feed exceeding 1 W directly to this port.

DC 18 V

The input power to this port shall be 18 V DC.

RF In (Spectrum Analyzer)

The **RF In** port is a precise 50 Ω N-type female connector that is used as the input signal port for spectrum analysis, signal analysis, and RF power measurement.



CAUTION

The maximum power allowed to the RF In port is +25 dBm. If the input power exceeds the limit, it may degrade the product performance or cause damage to the instrument in a worst case. Do not connect any power feed exceeding 1 W directly to this port.

Audio jack

The audio jack is labeled with a headphones icon. Plugging in headphones or earphones turns the speaker off.

USB

- **CLIENT:** This is a communication port that you can connect your instrument and your PC with application software JDViewer or JDRemote. You must install driver software for the instrument on to the computer. See “Appendix H – Device driver installation” on page 551 for more information.
- **HOST:** You can use this port to plug in an external USB memory to extend storage capacity or to upgrade the instrument’s firmware. It supports most USB memory devices with 32-bit file system. You can also use this port to connect an external power sensor, Bluetooth USB adapter, or P5000i fiber microscope. See “Appendix G – Bluetooth connection” on page 548 on how to set up and use the Bluetooth connection.

LAN

You can use this Ethernet communication port to connect your instrument and your PC using the application software JDViewer or Motorola WinLMF, if necessary. Two LEDs indicate data transfer activity and link status.

- **ACTIVITY:** The yellow LED is illuminated during data transfer.
- **LINK:** The green LED is illuminated when there is a valid communication connection.

E1/T1 for JD785A

You can use this E1/T1 input port to detect an error or alarm from E1/T1 signal and to transmit test pattern to E1/T1 transmission line connected through the provided RJ45 cable accessory.

GPIO for JD786A and JD788A

This General Purpose Input/Output (GPIO) port is factory use only.

External In

- **GPS:** You can plug in a GPS antenna to this SMA type female connector in order to get location information and highly accurate reference.
- **TRIGGER:** You can use this SMA type female connector to receive PP2S clock or 10 ms synchronization signals from an external timing reference.
- **REF:** You can use this SMA type female connector to receive 10 MHz, 13 MHz, or 15 MHz reference clock signals from an external frequency source.

Installing battery pack

You need to install the Lithium Ion battery pack provided with your instrument. Follow the instruction to install or remove the battery pack as needed.

Procedure

To install the battery pack:

1. Loosen the latching screw of the battery cover by turning counter clockwise.
 2. Slide out the battery cover to open.
 3. Insert the battery pack with the connector terminal side up and push in until it stops.
-

4. Slide in the battery cover to close.
5. Tighten the latching screw of the battery cover by turning clockwise.

To remove the battery pack:

1. Loosen the latching screw of the battery cover by turning counter clockwise.
2. Slide out the battery cover.
3. Hold the battery strap and pull it out.

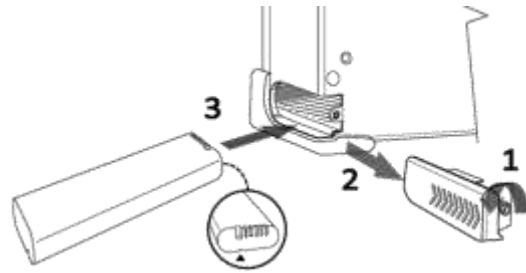

CAUTION

The battery pack that came with your instrument is Lithium Ion and it may, if not connected correctly, lead to explosion. In case you need to replace the battery, you must use one of the same kinds or compatible ones. You must dispose a battery according to your local safety and environmental regulations.

NOTE

It is recommended that you turn off the instrument to replace the battery. However, if you do not want to interrupt the current test, you can leave the module turned on with the AC power adapter plugged in.

Starting up the JD780A series

Use the power button to turn your JD780A series on or off. When external power is supplied via the AC/DC adapter, the upper orange LED is illuminated.

Procedure

To turn on:

1. Press and hold the  **POWER** button for a few seconds until the lower green LED indicator is illuminated.
2. Release the button and wait for a few seconds while booting up.

To turn off:

1. Press and hold the  **POWER** button for a few seconds until the lower green LED indicator goes out.
2. Release the button.

Managing files

The JD780A series lets you save and load screen, result, setup, limit, logging data, or Fail events depending on your selected measurement mode and option.

NOTE

If you see greyed-out menus as you change measurement modes, this indicates that the menu(s) are not available to be used.

Using save

You can save your current screen, result, setup, and limit into the internal memory or your external USB memory drive.

Procedure

1. Press the **SAVE/LOAD** hot key. The Save/Load screen menu bar appears.
2. Press the **Save** soft key.
3. Select the save option, from the following choices:

To save	Select	File type
Current screen	Save Screen > Screen	.png
Measurement result in a report format with comments	Save Screen > Report	.pdf
Measurement result	Save Result	.tra .gom .grr .jdt
Measurement result (.csv)	Save Result as CSV Format	.csv
Setup and test configuration	Save Setup	.sta
Limit setting	Save Limit	.jml
Logging data	Save Logging Data	.grr .gsr
Automatically screen or results that falls outside the defined limit settings (Failed event)	Save On Event	.png .tra .csv

The on-screen keyboard appears.

NOTE

Save Setup saves a test configuration only, not a measurement limit setting. You must use Save Limit to save your limit settings.

4. Type the name of the file in the **File Name** field with or without using a keyword.
 5. *Optional.*
 - To create or edit keywords, touch the **Edit Keywords** button, select your desired keyword button in the upper screen, type a keyword, and then tap the **Save** button on the keyboard. See “Editing or adding a custom keyword” on page 558 for more information.
 - To include a keyword in the file name, touch the **Append Keywords** button, select your desired keyword, and then tap the **Keyboard** button. See “Appending a keyword” on page 559 for more information.
 - To change the file location in the internal memory or to your USB memory drive, tap the **Location** button, select your desired file path using the touch screen or the rotary knob, and then press the **Apply** soft key.
 - To create a folder, press the **Create Folder** soft key, type a directory name, and then press the **Apply** soft key.
 6. Press the **Save** soft key.
-

Saving fail events

Depending on the measurement mode, you can let the instrument automatically save measurement screen or result that falls outside the defined limit settings or the Fail indicator is on. You can also set to save the first event and hold the measurement or to save all the events continuously.

Procedure

1. Press the **SAVE/LOAD** hot key. The Save/Load screen menu bar appears.
 2. Press the **Save** soft key.
 3. Press the **Save On Event** soft key.
 4. Press the **Save Type** soft key, and then select the save option: **Screen**, **Result**, or **Result as CSV Format**.
 5. *Optional.* Toggle the **Save Then Stop** soft key and select **On** in order to save the first event that falls outside the limit(s) and to hold the measurement. Otherwise, leave this feature off to save events continuously.
 6. Press the **Start** soft key to start saving. The on-screen keyboard appears.
 7. Type the name of the file in the **File Name** field with or without using a keyword.
 8. *Optional.*
 - To create or edit keywords, touch the **Edit Keywords** button, select your desired keyword button in the upper screen, type a keyword, and then tap the **Save** button on the keyboard. See “Editing or adding a custom keyword” on page 558 for more information.
 - To include a keyword in the file name, touch the **Append Keywords** button, select your desired keyword, and then tap the **Keyboard** button. See “Appending a keyword” on page 559 for more information.
 - To change the file location in the internal memory or to your USB memory drive, touch the **Location** button, select your desired file path using the touch screen or the rotary knob, and then press the **Apply** soft key.
 - To create a folder, press the **Create Folder** soft key, type a directory name, and then press the **Apply** soft key.
 9. Press the **Done** soft key.
The “**Event Save**” appears on the screen and the **Start** screen menu changes to **Stop**.
 10. Press the **Stop** soft key to end the event saving.
-

Saving logging data

You can save logging data in the following measurement modes: Interference Analyzer, E1/T1 Analyzer, Signal Analyzer OTA, and Auto Measure.

Procedure

1. Press the **SAVE/LOAD** hot key. The Save/Load screen menu bar appears.
 2. Press the **Save** soft key.
 3. Press the **Save Logging Data** soft key. The on-screen keyboard appears.
 4. Type the name of the file in the **File Name** field with or without using a keyword.
 5. *Optional.*
 - To create or edit keywords, touch the **Edit Keywords** button, select your desired keyword button in the upper screen, type a keyword, and then tap the **Save** button on the keyboard. See “Editing or adding a custom keyword” on page 558 for more information.
 - To include a keyword in the file name, touch the **Append Keywords** button, select your desired keyword, and then tap the **Keyboard** button. See “Appending a keyword” on page 559 for more information.
 - To create a folder, press the **Create Folder** soft key, type a directory name, and then press the **Apply** soft key.
 - To change the file location in the internal memory or to your USB memory drive, touch the
-

Location button, select your desired file path using the touch screen or the rotary knob, and then press the **Apply** soft key.

NOTE

In is recommended that you use an external USB memory drive to save logging data in the Auto Measure mode in order to have enough free space.

6. *Optional only in the **Auto Measure** mode.*
Toggle the **Save Screen** soft key and select **All** to save all the Auto Measure screens or **Fail** to save only the ones with the Fail on.
7. Press the **Save** soft key to start logging.
The "**Recording**" appears on the screen.
8. Press the **ESC** hard key to stop logging data and complete saving.

Using load

You can load your saved screen, result, setup, and limit from the internal memory or your external USB memory drive.

Procedure

1. Press the **SAVE/LOAD** hot key. The Save/Load screen menu bar appears.
2. Press the **Load** soft key. The Load screen menu bar appears.
3. Select the load option, from the following choices:

To load	Select
Saved screen or report	Load Screen
Measurement result	Load Result
Setup and test configuration	Load Setup
Limit setting	Load Limit
Logging data	Load Logging Data
Map file	Load Map
Scenario	Load Scenario

The file manager window appears.

4. Select the name of the file to be loaded from the internal memory or from your USB drive. Information of your selected file appears in the File Information pane.
5. Press the **Load** soft key.

Using file manager

The File Manager lets you copy, cut, paste, and delete data files saved in the internal memory or in your USB memory drive.

Procedure

1. Press the **SAVE/LOAD** hot key. The Save/Load screen menu bar appears.
2. Press the **File Manager** soft key. The file manager window appears.

-
3. To copy, cut, and paste, complete the following steps:
 - a. Select a file or folder by using the touch screen or the rotary knob.
 - b. Select the **Copy** or **Cut** soft key.
 - c. Select the location to which the file or folder to be pasted.
 - d. Press the **Paste** soft key.
 4. To delete, complete the following steps:
 - a. Select a file or folder by using the touch screen or the rotary knob.
 - b. Press the **Delete** soft key.
The confirmation dialog box appears.
Once the file or folder is deleted, you cannot recover it.
 - c. Select **OK** to delete.
 5. Press the **Exit** soft key or the **ESC** hard key to close the file manager window.
-

Configuring system

Setting frequency reference

You can improve measurement accuracy by setting frequency reference.

Procedure

1. Press the **SYSTEM** hot key.
 2. Press the **Freq Reference** soft key.
 3. Select the frequency reference option: **Internal**, **External 10 MHz**, **External 13 MHz**, **External 15 MHz**, or **GPS**.
-

Setting date and time

You can set the instrument' system clock to your region.

Procedure

1. Press the **SYSTEM** hot key.
 2. Select **System Configuration > Date/Time**. The current time zone information box appears.
 3. To change the standard time zone, complete the following steps:
 - a. Press the **Std Time Zone** soft key.
 - b. Select your time zone by using the rotary knob or arrow keys. You can also use the **Top/Bottom** or **Page Up/Down** soft keys.
 - c. Press the **ENTER** hard key to save your change. You can also press the rotary knob.
 4. To change the date format, complete the following steps:
 - a. Press the **Date Format** soft key.
 - b. Select **YYMMDD**, **MMDDYY**, or **DDMMYY** as needed.
 5. To set the date and time manually, complete the following steps:
 - a. Select **Year**, **Month**, **Day**, **Hour**, or **Minute** soft key as needed.
 - b. Enter a value by using numeric keys.
-

-
- c. Press the **Enter** soft key to save your change.
- 6. Press the **Apply** screen key to save and exit.
-

Setting language

You can change the system language for the menus, messages, and information on screen.

Procedure

- 1. Press the **SYSTEM** hot key.
 - 2. Select **System Configuration > Language**.
 - 3. Select the language option from the choices available.
-

Setting power on

Procedure

To set the power-on option:

- 1. Press the **SYSTEM** hot key.
 - 2. Press the **Power On** soft key.
 - 3. Select the power-on option, from the following choices:
 - **Last:** Boots up with the last state of the instrument before power-off or shut-down.
 - **Preset:** Boots up with the default settings preset in the factory.
 - **User:** Boots up with the user-defined setup.
When the User is selected, the User Setup menu under System becomes activated.
 - 4. *Optional.* To specify the user setup file, complete the following steps:
 - a. Press the **User Setup** soft key.
 - b. Select the name of the user setup file.
 - c. Press the **Done** soft key.
-

NOTE

The Preset option returns the instrument settings to the factory preset. It is recommended that you use this option when you experience badly misadjusted settings.

Changing display mode

You can change the instrument's display mode as needed.

Procedure

- 1. Press the **SYSTEM** hot key.
 - 2. Select **System Configuration > Display Mode**.
 - 3. Select a display mode from the choices: **Indoor**, **Outdoor**, and **Night**.
 - 4. The instrument optimizes screen colors to each choice.
-

Setting sleep time

You can set the amount of time up to 255 minutes to let the instrument automatically turn the backlight off and enter into power saving mode after no actions or data entries. Default setting is zero, which indicates that the sleep mode is turned off and screen backlight is always on.

Procedure

1. Press the **SYSTEM** hot key.
 2. Select **System Configuration > Sleep Time**.
 3. Enter the amount of minutes by using the numeric keys. You can also use the rotary knob.
 4. Press the **Enter** soft key.
-

Adjusting LCD brightness

You can adjust display brightness from one to ten as needed. The larger number you set, the brighter the display becomes.

Procedure

1. Press the **SYSTEM** hot key.
 2. Select **System Configuration > LCD Brightness**.
 3. Enter a value by using the numeric keys. You can also use the rotary knob.
 4. Press the **Enter** soft key.
-

Adjusting volume

You can turn the sound on or off or adjust the volume from one to ten as needed.

Procedure

1. Press the **SYSTEM** hot key.
 2. Select the sound option, from the following choices:
 - To turn the sound or alarm off, toggle the **Sound** soft key and select **Off**.
 - To turn the sound or alarm on, toggle the **Sound** soft key and select **On**.
 - To adjust the volume, complete the following steps:
 - a. Press the **Sound** soft key.
 - b. Enter a value by using the numeric keys.
 - c. Press the **Enter** soft key.
-

Upgrading firmware

It is recommended that you maintain your instrument up-to-date with its latest firmware in order to achieve the instrument's optimal performance.

Checking installed firmware version

Procedure

1. Press the **SYSTEM** hot key.
2. Press the **HW/FW Info** soft key.
3. Find the installed version number in the **Firmware** field.
4. From a computer with Internet access, visit [JDSU's Software Updates website](#) and check if your installed firmware is the latest one. Do the steps **5-6** if you want to update your firmware with using your USB memory drive.
5. Download a latest firmware file from the website to the root directory of your USB memory drive.

NOTE

It is recommended that you format your memory drive to have enough space to download the file.

6. Unzip the download file into the root directory of your USB memory stick.
A firmware file (*.fw) and a firmware release note (*.pdf) are extracted.
-

Installing new firmware

To update your firmware, you can choose either way of using your USB memory drive or accessing the FTP server over the network.

Upgrading from USB memory drive

Procedure

1. Power your instrument via the AC-DC adapter to prevent any severe damage to your instrument caused by a power-off in the middle of the upgrade, which may require a repair in the factory.
2. Plug in the USB memory drive to the **USB Host** port of your instrument.
3. Press the **SYSTEM** hot key.
4. Select **More (1/2) > Upgrade > USB**.
The file manager window appears.
5. Highlight the firmware file (.fw) saved in the root directory of your USB drive.
6. Press the **Select** soft key.
The Update Firmware dialog box appears.
7. Press the **OK** button to start to install the new firmware.
The Upgrade Status bar appears.
The instrument reboots the system automatically and completes upgrading.

NOTE

Firmware upgrade will be done within 30 minutes or so in most cases, but depending on the number of files to be reconfigured, it may take longer than that.

8. After the instrument restarted, check the installed firmware version and DSP versions in the System settings. Refer to the firmware release note to find correct DSP version and compatible application software versions.
-



WARNING

Do not remove the USB drive while upgrading the firmware.

Upgrading from FTP server

Procedure

1. Power your instrument via the AC-DC adapter to prevent any severe damage to your instrument caused by a power-off in the middle of the upgrade, which may require a repair in the factory.
2. Press the **SYSTEM** hot key.
3. Select **More (1/2) > Upgrade > FTP Server**.
The upgrade server dialog box appears.

NOTE

Older version of firmware does not have the FTP Server option. It is recommended that you update your firmware with the USB option first.

4. Enter **ftp2.jdsu.com** in the server address field.
5. Enter your proxy server address in the proxy server field, if necessary.
Contact your system administrator for your proxy server information.
6. Tap the **Check** button to check if the installed firmware version is the latest one.
7. Do one of the following:
 - If you view the latest firmware version information, tap the **Install** button to continue upgrading.
 - If the message “**Your firmware is up to date.**” is displayed, tap the **Cancel** button.

NOTE

Firmware upgrade will be done within 30 minutes or so in most cases, but depending on the number of files to be reconfigured, it may take longer than that.

8. After the instrument restarted, check the installed firmware version and DSP versions in the System settings. Refer to the firmware release note to find correct DSP version and compatible application software versions.
-

Managing licenses

The License Manager lets you view installed options, install additional ones, and load evaluation licenses.

Checking options

Procedure

To view the list of installed or installable options:

1. Press the **SYSTEM** hot key.
 2. Select **More (1/2) > License Manager**. The License Manager screen menu bar appears.
 3. Select the menu, from the following choices:
 - To view the installed options, select the **Installed Options** soft key.
The list of options appears. The “(T)” indicates temporary licenses.
 - To view the installable options, select the **Installable Options** soft key.
 4. Press the **PREV** hard key to return to the previous screen.
-

Installing options

Procedure

To install an option that you have purchased:

1. Press the **SYSTEM** hot key.
 2. Select **More (1/2) > License Manager**.
The License Manager menu bar appears.
 3. Select the **Install an Option** soft key. The Installable Options window appears.
 4. Select the name of the option from the list by using the rotary knob.
 5. Press the **ENTER** hard key. You can also press the rotary knob.
The License Code bar appears.
 6. Type the number of the license to activate by using the numeric keys.
 7. Press the **ENTER** hard key. You can also select the **Enter** soft key.
-

Loading temporary license

The temporary license that you received from JDSU is intended for your evaluation only and it expires after its specified time limit.

Procedure

To load a temporary license that you have received for evaluation:

1. Press the **SYSTEM** hot key.
 2. Select **More (1/2) > License Manager**.
The License Manager menu bar appears.
 3. Select the **Load Temp License** soft key. The file manager window appears.
 4. Select the name of the license file.
 5. Press the **Load** soft key.
 6. *Optional.* You can check the loaded license using the **Installed Options** menu.
-

Viewing OSS license

The JD780A series incorporates software that is covered by either the GNU General Public license or GNU Lesser General Public License. Check the OSS license notification for more details.

Procedure

To view OSS license notification and distribution:

1. Press the **SYSTEM** hot key.
 2. Select **More (1/2) > License Manager**.
The License Manager menu bar appears.
 3. Select the **OSS License** soft key.
The Open Source Code Notification & Distribution screen appears.
 4. Press the **ESC** hard key to return to your previous screen.
-

Performing service diagnostic

The Service Diagnostic lets you view system log, perform self test, revert the instrument settings to its factory settings, or perform touch alignment.

Viewing system log

Procedure

1. Press the **SYSTEM** hot key.
 2. Select **More (1/2) > Svc Diagnostic > System Logging**.
 3. *Optional.* Press the **Save** soft key to save the system log as a `.log` file type.
 4. Press the **PREV** hard key to return to the previous screen.
-

Running self-test

You can run a self-test on your instrument boards and modules.

Procedure

1. Press the **SYSTEM** hot key.
 2. Select **More (1/2) > Svc Diagnostic > Self Test**.
The on-screen instruction appears.
 3. Connect a test cable between the **Reflection/RF Out** port for Cable and Antenna Analyzer and the **RF In** port for Spectrum Analyzer.
 4. Press the **Start** soft key.
The test result window appears.
 5. *Optional.* Press the **Save Screen** soft key to save the self-test results.
 6. Press the **PREV** hard key to return to the previous screen.
-

Performing factory reset

The Factory Reset is used only when you want to purge all the user settings and data stored in the system and return to the instrument's factory state.

Procedure

1. Press the **SYSTEM** hot key.
 2. Select **More (1/2) > Svc Diagnostic > Factory Reset**.
The confirmation window appears.
 3. Press the **Yes** soft key to continue. Otherwise, select **No**.
 4. Press the **PREV** hard key to return to the previous menu.
-

NOTE

It is recommended that you copy your setup or result data to an external USB memory drive so that you can restore them later.

Re-aligning touch screen

When you consistently experience of the instrument responding improperly to your touch on the screen, you may need to perform this touch-screen alignment.

Procedure

1. Press the **SYSTEM** hot key.
 2. Select **More (1/2) > Svc Diagnostic > Touch Alignment**.
The white screen with a plus sign (+) in the upper-left corner appears.
 3. Touch the plus sign and repeat until the previous screen is back on.
-

Using system administration

The Administration is used to disable editing limits, enable modifying online help, or change administration password.

Logging in

You need to log in first to access the administration menus.

Procedure

1. Press the **SYSTEM** hot key.
 2. Select **More (1/2) > Administration**. The password box appears.
 3. Enter <password> by using the numeric keys.
Default password is "0000". To change the password, see "Changing password" on page 42.
 4. Press the **Apply** soft key.
-

Changing password

Procedure

1. Press the **SYSTEM** hot key.
 2. Select **More (1/2) > Administration**, and then enter your password.
 3. Press the **Change Password** soft key. The new password box appears.
 4. Enter a new password up to eight digits by using the numeric keys.
 5. Press the **Apply** soft key. The reconfirmation box appears.
 6. Enter the new password again by using the numeric keys.
 7. Press the **Apply** soft key to complete changing password.
-

Locking limit key

You can lock the **LIMIT** hot key and disable editing predefined limit settings to prevent any unintentional changes, which could result in incorrect measurements.

Procedure

1. Press the **SYSTEM** hot key.
 2. Select **More (1/2) > Administration**, and then enter your password.
 3. Toggle the **Edit Limit** soft key and select **Disable** to lock the **LIMIT** hot key or **Enable** to unlock the key.
-

NOTE

Disabling the Edit Limit limits the access to the **LIMIT** hot key only. The Limit features including displaying limit line(s) and Pass/Fail result function properly as predefined.

Modifying online help

The online help can be modified if needed.

Procedure

1. Press the **SYSTEM** hot key.
 2. Select **More (1/2) > Administration**, and then enter your password.
 3. Toggle the **Modify Help** soft key and select **Enable** to allow modifying the online help or **Disable** to restrict any modification.
-

Running IP test

You can test an Internet Protocol (IP) configuration of the cell site's backhaul.

Procedure

1. Press the **SYSTEM** hot key.
 2. Select **More (1/2) > Utility > IP Test**.
 3. Select the command option, from the following choices:
 - To display the route and measure transit delays of packets, toggle the **Commands** soft key and select **Traceroute**.
 - To display the reachability and measure the round-trip time, toggle the **Commands** soft key and select **Ping**.
 4. To set the destination IP address to be tested, complete the following steps:
 - a. Press the **Destination IP** soft key.
 - b. Press the **First Octal** soft key.
 - c. Enter a value, and then press the **Enter** soft key.
 - d. Press the **Second Octal** soft key and repeat step c.
 - e. Press the **Third Octal** soft key and repeat step c.
 - f. Press the **Fourth Octal** soft key and repeat step c.
 5. Press the **Execute** soft key and select **Start** to start testing. Test result is displayed on the screen as the test is progressing.
 6. Press the **Execute** soft key and select **Stop** to stop testing.
 7. *Optional.* Press the **Save** soft key to save the test result as a `.txt` file type.
-

Activating StrataSync

StrataSync is a cloud-based solution that provides asset, configuration, and test data management for JDSU instruments. StrataSync manages and tracks test instruments, collects and analyzes results from the entire network, and informs and trains the workforce.

The JD780A series is compatible with the JDSU StrataSync cloud. This optional capability allows you to manage your instrument inventory ensuring you know where all your valuable equipment is and which engineer is using it. In addition, it allows you to keep your instruments current through the remote upgrade capability that ensures all instruments have the latest firmware. It also enables the centralized distribution of configuration settings to ensure all your engineers use the same instrument settings resulting in consistent measurements.

Once testing is completed, the trace files can be uploaded onto StrataSync for secure storage and sharing. This sharing capability allows engineers who have a problem they cannot resolve to request help from an expert who can analyze the trace file via StrataSync using applications such as JDViewer, JDFileViewer, JDPowerMeter, etc. from anywhere without having to be at the instrument, helping resolve problems even faster.

Establishing a connection to StrataSync

Procedure

1. Press the **SYSTEM** hot key.
2. Select **More (1/2) > Utility > StrataSync**.
The StrataSync setting window appears as shown in **Figure 91**.
3. Enter **<server address>** in the **Server Address** field for StrataSync.
The server address at the time of this document production is "**stratasync.jdsu.com**", which may change.

NOTE

JDSU provides you with the information required to access StrataSync at your purchase of StrataSync, including the **Server Address**, **Account ID**, and **Port number**. See "JD780A Series Common Options" on page 555 for more information on available options.



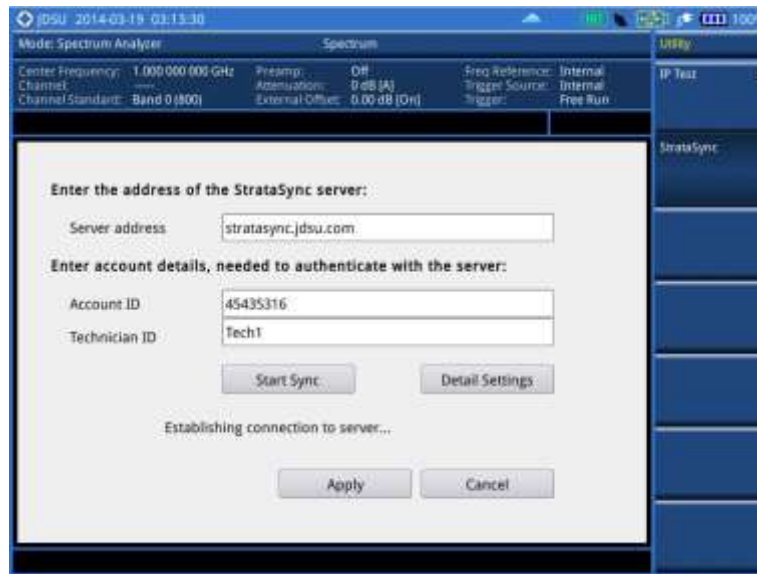

4. Enter **<account number>** in the **Account ID** field.
 5. Enter **<technician number>** in the **Technician ID** field.
 6. To set the port number and proxy server address, complete the following steps:
 - a. Tap the **Detail Settings** button.
The input dialog box appears.
 - b. Enter **<port number>** in the **Port** field.
 - c. Enter **<proxy server address>** in the **Proxy Server** address, if necessary.
Contact your system administrator for your proxy server information.
 - d. Tap the **Apply** button to save and exit.
 7. Tap the **Start Sync** button.
Once successfully synchronized, the text "Successfully synchronized with server" appears and the StrataSync status icon changes accordingly.
 8. Tap the **Apply** button to exit.
-

Figure 3 StrataSync setting window



StrataSync status indicators

The StrataSync indication icons provide you with the connection and activity status.

Indicator	Description
	Indicates that your instrument is idle to be connected and synchronized with the StrataSync server.
	Indicates that your instrument is acquiring an authentication, synchronizing with the server, and sharing data.
	Indicates that your instrument is synchronized successfully.
	Indicates that your instrument failed to synchronize with the StrataSync server or encountered an error.

Setting communication

JD780A series provides several methods for you to connect your instrument with application software or other instruments and devices.

Configuring Ethernet

You can configure a network to connect your JD780A series and PC with JDViewer or JDRemote via Ethernet.

Procedure

1. Press the **SYSTEM** hot key.
2. Select **System Configuration > Ethernet Config**.
The Ethernet Configuration box appears.
3. Select the IP addressing option, from the following choices:

-
- To enable automatic IP addressing, toggle the **Mode** soft key and select **DHCP**.
 - To manually assign fixed IP addresses, complete the following steps:
 - a. Toggle the **Mode** soft key and select **Static**.
 - b. Select **Field > IP Address**.
 - c. Press the **First Octal** soft key.
 - d. Enter a value, and then press the **Enter** soft key.
 - e. Press the **Second Octal** soft key and repeat step **d**.
 - f. Press the **Third Octal** soft key and repeat step **d**.
 - g. Press the **Fourth Octal** soft key and repeat step **d**.
 - h. Select **Field > Subnet Mask** and repeat steps **c-g**.
 - i. Select **Field > Gateway** and repeat steps **c-g**.
 - 4. Press the **Apply** soft key to complete the network configuration.
 - 5. Press the **ESC** hard key to exit.
-

Setting for JDViewer and JDRemote

The **App SW** is set by default to make it easy to connect your instrument to JDViewer or JDRemote. After using other remote interfaces such as SCPI, LMF, and USBTMC, it is recommended that you set the LAN and USB settings back to App SW.

Procedure

1. Press the **SYSTEM** hot key.
 2. Press the **System Configuration** soft key.
 3. Press the **Remote Interface** soft key and then do the following:
 - Select the **LAN** soft key and then press the **App SW** soft key.
 - Select the **USB** soft key and then press the **App SW** soft key.
-

Setting USBTMC mode

The USB Test & Measurement Class (USBTMC) is a standard for programmatic control of USB-based test instruments that defines protocols used to send and receive messages. If you want to use the USBTMC protocol to communicate with the instrument remotely, you can turn this TMC Mode on.

Procedure

1. Press the **SYSTEM** hot key.
 2. Select **System Configuration > Remote Interface > USB**.
 3. Press the **USBTMC** soft key.
The confirmation dialog box appears.
 4. Press the **USBTMC** soft key again to confirm the mode change and reboot the instrument.
-

NOTE

After using the USBTMC mode, you may want to set this setting back to **App SW** if you use JDViewer mainly for remote controlling your JD780A series.

Setting SCPI mode

You can use SCPI commands to control your JD780A series remotely.

Procedure

1. Press the **SYSTEM** hot key.
 2. Select **System Configuration > Remote Interface > LAN**.
 3. Press the **SCPI** soft key.
-

NOTE

After using the SCPI mode, you may want to set this setting back to **App SW** if you use JDViewer or JDRemote mainly.

Configuring LMF setting

The Local Maintenance Facility (LMF) setting is used in order to perform TX Calibration and TX Audit on Motorola's CDMA/EV-DO BTS in the RF Power Meter mode. See "Appendix F – Motorola CDMA/EV-DO LMF" on page 546 for more information.

Enabling Bluetooth connection

You can also use the Bluetooth mode to enable communicate between your instrument and your computer with application software such as JDRemote and JDViewer or to transfer files to a Bluetooth storage device. See "Appendix G – Bluetooth connection" on page 548 for more information.



Analyzing Measurement Results

This chapter provides instructions on how to use JD780A series' capabilities for measurement analysis. Topics discussed in this chapter are as follows:

- Using marker49
- Using peak search50

Using marker

Marker



Marker is used to get the information about a specific trace. Six markers can be set on the display and each marker can be used independently. The X and Y coordinates of the trace are displayed when the marker is placed on any position of the trace. The position displaying the marker's X and Y coordinates may be slightly different for each measurement mode and refer to the description of each measurement. There are three different marker types available: Normal, Delta, and Delta pair. Marker position can be set manually by entering numeric values (frequency) when one of the marker types is selected.

- **Select Marker:** Selects an active marker whose position can be changed with the rotary knob or the arrow keys. The assigned number of the active marker is displayed in the Select Marker menu box and the active marker number is also displayed right next to the active marker on the trace when the Marker View is set to On.
- **Marker View:** Displays the selected marker on the screen or hides it. When the Marker View is turned off and then on again in the same measurement mode, markers appear at the previous positions. If a measurement mode is changed, markers are not restored to their previous positions.
- **Normal:** This Normal marker type provides the reading of a marker position on the trace along with the marker number between one and six.
- **Delta:** This Delta marker type is associated with a Normal marker. A Normal marker must be set before a Delta marker is set. When the Delta marker is set, the position set by the Delta marker becomes the reference position of the Normal marker and the marker's X and Y values displays the difference compared with the Delta marker.
- **Delta Pair:** This Delta Pair marker type is associated with a Normal marker. A Normal marker must be set before a Delta Pair marker is set. When the Delta Pair marker is set, the position set by the Delta Pair marker becomes the reference position of the Normal marker and the marker's X and Y values displays the difference compared with the Delta Pair marker. The reference position will be varied in accordance with trace change.
- **Marker All Off:** Turns all the markers the screen off. When the Marker View is selected for those markers, the instrument displays those markers back at the previous position. If a measurement mode is changed, current settings are not restored.
- **Marker →:** Sets the X coordinate of the active marker as selected.
 - **Marker→Center:** Sets the frequency of the active marker to the center frequency of spectrum analyzer.
 - **Marker→Start:** Sets the frequency of the active marker to the start frequency of spectrum analyzer.
 - **Marker→Stop:** Sets the frequency of the active marker to the stop frequency of spectrum analyzer.
- **Frequency Count:** This Frequency Count is used when a highly accurate reading of the frequency is needed for the active marker on the signal. The measurement sweeps get significantly slower because the instrument runs the measurement of the signal peak with 1 Hz resolution in background. Toggle this key between **On** and **Off** to enable or disable the frequency count function for the selected marker.
- **Noise Marker:** This Noise Marker is used to measure a noise adjacent to a signal by averaging several data points to calculate the readout for the Noise Marker as if making a measurement using a 1 Hz bandwidth. Toggle this key between **On** and **Off** to enable or

disable the noise marker function for the selected active marker.

NOTE

Frequency Count and Noise Marker functions are used only in the Spectrum Analyzer mode.

Using peak search

Peak search



Each time the Peak Search soft key is pressed, the active marker is positioned at the highest peak of the trace.

- **Peak Search:** Moves the active marker to the highest peak of the trace.
- **Next Peak:** Moves the active marker to the second highest peak of the trace.
- **Next Peak Right:** Moves the active marker to the highest peak to the right of its current position.
- **Next Peak Left:** Moves the active marker to the highest peak to the left of its current position.
- **Min Search:** Moves the active marker to the lowest peak of the trace.
- **Always Peak:** When the **Always Peak** is set to **On**, the instrument moves the active marker automatically to the highest peak of the trace every time the trace is refreshed.

Using Spectrum Analyzer

This chapter provides instructions for using the Spectrum Analyzer function. Topics discussed in this chapter are as follows:

■ Introduction	52
■ Display overview	52
■ Connecting a cable	53
■ Selecting measurement mode	54
■ Conducting spectrum measurements	61
■ Conducting RF measurements	64

Introduction

The advantage of using the Spectrum Analyzer is easy to verify the presence of unwanted signals such as spurious and harmonics, which are normally very hard to identify in time domain analysis.

Performance assurance in wireless communication systems includes the observation of the out-of-band signal characteristics in order to identify the presence of harmonic signals. Harmonic signals of a carrier may interfere with other signals far out of the transmission band, or harmonic signals from other transmitter may interfere with in band signals affecting the spectral integrity.

In these days when wide variety of wireless communication services are provided in frequency bands assigned very closely to each other, it is critical to ensure that each communication service is carried out within their assigned frequency band minimizing interference with adjacent frequency bands. The Adjacent Channel Power Ratio (ACPR) characteristic of a power amplifier or other RF components is an important factor in evaluating the system performance.

The JD780A series is the optimal solution to perform following measurements:

- Spectrum Analysis
 - Spectrum
- RF Analysis
 - Channel Power
 - Occupied Bandwidth
 - Spectrum Emission Mask
 - Adjacent Channel Power (ACP)
 - Multi-ACP
 - Spurious Emissions
 - AM/FM Audio Demodulation
 - Field Strength
 - Route Map
 - Dual Spectrum
 - PIM Detection (Single and Multiple Carriers)

Display overview

Figure 4 provides overview of each segment of the measurement screen.

Figure 4 Spectrum measurement screen

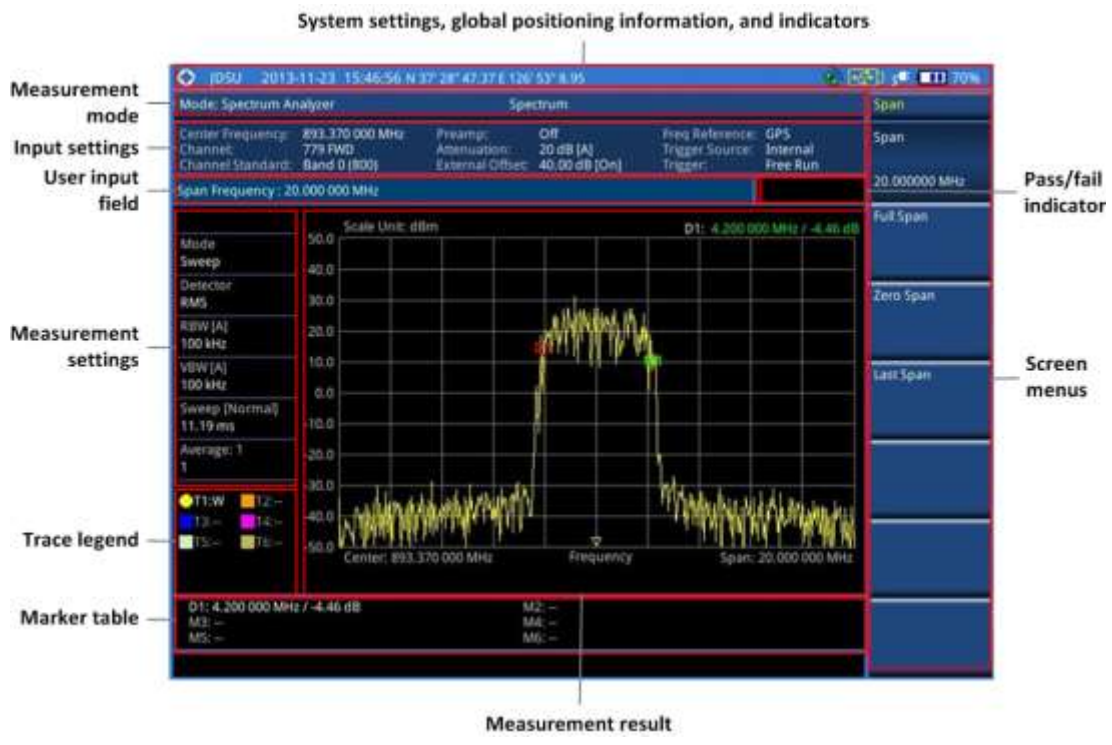

Connecting a cable

There are two ways that you can make a connection of your instrument and the base station to be tested: direct or indirect.

Procedure

To make a direct connection:

1. Connect the **Spectrum Analyzer RF In** port of the JD780A series and the PA output port of BTS as shown in Figure 5.

To make an indirect connection:

1. Connect the **Spectrum Analyzer RF In** port of the JD780A series and the monitor (test) port of BTS as shown in Figure 6.

Figure 5 Direct connection



Figure 6 Indirect connection



 **CAUTION**
 The maximum power for the **Spectrum Analyzer RF In** port is +25 dBm (0.316 W). If the input signal level to be measured is greater than +25 dBm, use a **High Power Attenuator** to prevent damage when you directly connect the signal to the instrument or connect the signal from the coupling port of a directional coupler.

Selecting measurement mode

Procedure

1. Press the **MODE** hard key.
2. Press the **Spectrum Analyzer** soft key. The **Measure Off** mode is selected by default.
3. To select a measurement mode, press the **MEASURE** hot key and then select the measurement mode:
 - Channel Power
 - Occupied BW
 - Spectrum Emission Mask
 - Adjacent Channel Power
 - Multi-ACP
 - Spurious Emissions
 - AM/FM Audio Demod
 - Field Strength
 - Route Map
 - Dual Spectrum
 - PIM Detection > Single Carrier or Multiple Carrier

Configuring test parameters

Setting frequency

You need to set the frequency range to be measured either with the center frequency and span or with the start and stop frequencies. You can also set the frequency with the channel number and span.

Procedure

To set the center frequency and span:

1. Press the **FREQ/DIST** hard key.
2. Toggle the **Unit** soft key and select **Freq**.
3. Press the **Center Frequency** soft key.
4. Enter a value by using the numeric keys. You can also use the rotary knob or the arrow keys.
5. Select the unit: **GHz**, **MHz**, **kHz**, or **Hz**.
6. Press the **Span** soft key, and then do one of the following:
 - To set the span manually, select **Span**, enter a value, and then select the unit.
 - To set the span automatically, select **Full Span**, **Zero Span**, or **Last Span** as needed.

NOTE

The **Zero Span** option is available only in the Spectrum mode. If you have selected **Zero Span**, select **TRIGGER > Free Run**, **External**, **GPS**, **Video**, or **Display Position**.

To set the start and stop frequencies:

1. Press the **FREQ/DIST** hard key.
2. Toggle the **Unit** soft key and select **Freq**.
3. Press the **Start Frequency** soft key.
4. Enter a value by using the numeric keys. You can also use the rotary knob or the arrow keys.
5. Select the unit: **GHz**, **MHz**, **kHz**, or **Hz**.
6. Press the **Stop Frequency** soft key.
7. Enter a value by using the numeric keys. You can also use the rotary knob or the arrow keys.
8. Select the unit: **GHz**, **MHz**, **kHz**, or **Hz**.

To set the channel number and span:

1. Press the **FREQ/DIST** hard key.
 2. Toggle the **Unit** soft key and select **Channel**.
 3. To select the standard channel, complete the following steps:
 - a. Press the **Channel Std** soft key. The standard channel window appears. See "Appendix C – Band, frequency & channel standard" on page 541 for more information.
 - b. Select the band to be measured by using the rotary knob, the arrow keys, or the **Page Up/Page Down** soft keys.
 - c. Press the **Select** soft key or the rotary knob to confirm the selection.
 4. Toggle the **Link** soft key to select the sweep direction and select **Fwd** for forward or **Rev** for reverse.
 5. To set the channel number, complete the following steps:
 - a. Press the **Channel Number** soft key.
 - b. Enter a value by using the numeric keys.
 - c. Press the **Enter** soft key or **ENTER** hard key to complete the entry. The instrument automatically displays the corresponding center frequency value for the selected channel number.
 6. To set the span, complete the following steps:
 - a. Press the **Span** soft key.
-

- b. Select the span option, from the following choices:
 - To set the span manually, select **Span**, enter a value, and then select the unit.
 - To set the span automatically, select **Full Span**, **Zero Span**, or **Last Span** as needed.

NOTE

The **Zero Span** option is available only in the Spectrum mode. If you have selected **Zero Span**, select **TRIGGER > Free Run**, **External**, **GPS**, **Video**, or **Display Position**.

Optional. To define the amount of frequency increment for the rotary knob:

1. Press the **Frequency Step** soft key, if the **Freq** is selected.
2. Enter a value by using the numeric keys.
3. Press the unit: **GHz**, **MHz**, **kHz**, or **Hz**.

Optional. To define the amount of channel increment for the rotary knob:

1. Press the **Channel Step** soft key, if the **Channel** is selected.
2. Enter a value by using the numeric keys.
3. Press the **Enter** soft key.

NOTE

This setting is not used in the Spurious Emissions mode.

Setting amplitude

Reference level and attenuation

You can set the reference and attenuation levels automatically or manually to optimize the display of the traces measured, as you desire.

Procedure

To automatically set the reference and attenuation level:

1. Press the **AMP/SCALE** hard key.
2. Press the **Auto Scale** soft key.
Each time you press this key, both of the Y-axis scale and input attenuation level change to be optimized with some margin.

To set the reference or attenuation level manually:

1. Press the **AMP/SCALE** hard key.
2. To set the maximum reference level on the Y-axis manually, complete the following steps:
 - a. Press the **Reference Level** soft key.
 - b. Enter a value by using the numeric keys or the rotary knob with 10 dB increments.
 - c. Press the **dBm** soft key or the **ENTER** hard key.
3. To set the attenuation option, select one from the following choices:
 - To set the input attenuator's level automatically, select **Attenuation > Auto**.

NOTE

It is recommended that you set the **Attenuation** to **Auto** in most situations so that the level of the input attenuator can be set automatically according to your input signal level.

- To set the input attenuation manually up to 55 dB to optimize S/N, complete the following

steps:

- a. Select **Attenuation > Manual**.
 - b. Press the **Attenuation Value** soft key to set the level.
 - c. Enter a value between 0 and 55 in fives by using the numeric keys.
 - d. Press the **dB** soft key or the **ENTER** hard key.
- To couple the input attenuator's level with your reference level setting, select **Attenuation > Couple**.
As you increase the reference setting, the attenuation level also increases accordingly.

Optional. To change the scale unit:

1. Select **More (1/2) > Units**.
2. Select the unit of the display scale: **dBm**, **dBV**, **dBmV**, **dBμV**, **V**, or **W**.
The scale unit on the screen changes accordingly.

NOTE

For the Field Strength mode, the units change to **dBμV/m**, **dBmV/m**, **dBV/m**, **Volt/m**, **Watt/m²**, and **dBm/m²**.

Pre-amplifier

You can turn the internal pre-amplifier on to correct and compensate for the gain of the preamplifier so that amplitude readings show the value at the input connector.

Procedure

1. Press the **AMP/SCALE** hard key.
 2. Toggle the **Preamp** soft key and select **On** or **Off** as needed.
-

NOTE

You can turn the Preamp on when the input attenuation range is from 0 dB to 10 dB. If the attenuation value is manually set to greater than 10 dB, the instrument will automatically turn off the pre-amplifier to display low-level signal properly on the chart.

External offset

You can turn the **External Offset** on and manually set the external offset value. An offset consists of a cable loss and a user offset and the measurement result shows the value reflecting both offset values. When the external offset value is set at 40 dB in the Spectrum mode, the measurement result compensates 40 dB at both the Spectrum Analyzer and Signal Analyzer modes

Procedure

To set the external offset:

1. Press the **AMP/SCALE** hard key.
2. Toggle the **External Offset** soft key and select **On**.
3. Enter a value by using the numeric keys.
4. Press the **dB** soft key to complete the entry.

To turn the external offset off:

1. Press the **AMP/SCALE** hard key.
-

-
2. Toggle the **External Offset** soft key and select **Off**.
-

NOTE

This setting is not used in the Field Strength mode.

Scale per division

You can use the **Scale/Div** feature available for the spectrum measurement screen. It represents the value of one division on the horizontal scale. The default setting is 10 dB per division and the maximum value can be set up to 20 dB.

Procedure

To set the scale per division:

1. Press the **AMP/SCALE** hard key.
 2. Select **More (1/2) > Scale/Div**.
 3. Enter a value between 1 and 20 by using the numeric keys.
 4. Press the **dB** soft key to complete the entry.
-

Setting bandwidth

You can manually set the Resolution Bandwidth (RBW), Video Bandwidth (VBW), and the proportional VBW based on the designated RBW. Selecting **Auto** changes the value to correspond to your frequency span setting for RBW and to the current RBW and VBW/RBW settings for VBW.

Procedure

To automatically set the RBW and VBW to your selected VBW/RBW ratio:

1. Press the **BW/AVG** hard key.
2. Press the **VBW/RBW** soft key to set the proportional VBW based on the designated RBW. Table 9 shows the ratio example for 30 kHz RBW.
3. Select the ratio: **1, 0.3, 0.1, 0.03, 0.01, or 0.003**.
4. Toggle the **RBW** soft key and select **Auto**.
5. Toggle the **VBW** soft key and select **Auto**.

The RBW or VBW value on the screen changes accordingly based on the span.

To manually set the RBW or VBW to your selected VBW/RBW ratio:

1. Press the **BW/AVG** hard key.
2. Press the **RBW** soft key.
3. Enter a value between 1 Hz to 3 MHz in 1-3 sequence by using the numeric keys.
4. Select the unit: **MHz, kHz, or Hz**.
The RBW setting automatically changes to **Manual**.
5. Press the **VBW** soft key.
6. Enter a value by using the numeric keys.
7. Select the unit: **MHz, kHz, or Hz**.
The VBW setting automatically changes to **Manual**.

The RBW or VBW value on the screen changes accordingly.

NOTE

This setting is not used in the Spurious Emissions mode.

Table 10 VBW/RBW ratio example

RBW	Ratio (VBW/RBW)	VBW
30 kHz	1:1	30 kHz
	1:0.3	10 kHz
	1:0.1	3 kHz
	1:0.03	1 kHz
	1:0.01	300 Hz
	1:0.003	100 Hz

Setting average

You can set the number of measurements to be averaged for the trace presentation. A maximum of 100 times of averaging can be set. When the averaging reaches to your setting, a new measurement value replaces the measurement value in sequence from the earliest.

Procedure

1. Press the **BW/AVG** hard key.
 2. Press the **Average** soft key.
 3. Enter a value between 1 and 100 as needed by using the numeric keys.
 4. Press the **Enter** soft key.
-

Setting sweep

The **SWEEP** hot key is used to set and control the sweep time, sweep mode, gated sweep settings, and gated sweep on or off.

Sweep time

You can set the sweep time automatically or manually. Manual setting allows you to set the sweep time beyond an automatic setting.

Procedure

1. Press the **SWEEP** hot key.
 2. Select the sweep time option, from the following choices:
 - To automatically set, toggle the **Sweep Time** soft key and select **Auto**.
 - To manually set, complete the following steps:
 - a. Press the **Sweep Time** soft key.
 - b. Enter a value by using the numeric keys.
 - c. Select the unit: **Sec**, **mSec**, or **µSec**.
The sweep time mode automatically changes to **Manual**.
-

NOTE

This setting is not used in the Spurious Emissions mode.

Sweep mode

The default settings of the sweep mode are **Continue** and **Normal** to sweep continuously at a normal speed for most on-going measurements. If you want to hold the measurement or get a single sweep, you can change the sweep mode.

Procedure

To select the single sweep mode:

1. Press the **SWEEP** hot key.
2. Toggle the **Sweep Mode** soft key and select **Single**. You can also use the **HOLD** hot key. The letter **HOLD** in red appears and the sweeping is paused.
3. *Optional.* Press the **Sweep Once** soft key to get a new measurement.
4. *Optional.* To speed up sweeping, press the **Sweep Mode** soft key and then select **Fast**.

NOTE

Selecting **Sweep Mode > Fast** may reduce the measurement accuracy, but it is useful to identify the existence of interfering signals.

To return to the continuous sweep mode:

1. Toggle the **Sweep Mode** soft key and select **Continue**. You can also use the **HOLD** hot key. The letter **HOLD** in red disappears and the sweeping resumes.
-

NOTE

This setting is not used in the in the Field Strength mode, the AM/FM Audio Demodulation mode, and the Route Map mode.

Gated sweep

You can configure the gated sweep settings with an internal or external trigger source. If you select **Gated Sweep Settings**, you can view the signal in time domain.

Procedure

1. Press the **SWEEP** hot key.
 2. Press the **Gated Sweep Settings** soft key.
 3. *Optional.* Adjust sweep time to allow enough time for a cycle by completing the following steps:
 - a. Press the **Zero Span Time** soft key.
 - b. Enter a value by using the numeric keys.
 - c. Select the unit: **Sec**, **mSec**, or **µSec**.
 4. Set the period, if using the internal trigger source, by doing one of the following:
 - To select the preset period, complete the following steps:
 - a. Toggle the **Period** soft key and select **StdSignal**.
 - b. Press the **StdSignal** soft key, and then select the period: **GSM (4.615 ms)**, **WCDMA (10 ms)**, **LTE (10 ms)**, **EV-DO (5 ms)**, **TD-SCDMA (5 ms)**, or **WiMAX (10 ms)**.
 - To manually set the period, complete the following steps:
-

- a. Toggle the **Period** soft key and select **Manual**.
 - b. Press the **Period** soft key to enter the amount of time.
 - c. Enter a value by using the numeric keys.
 - d. Select the unit: **Sec**, **mSec**, or **µSec**.
5. Press the **TRIGGER** hot key, and then do one of the following:
 - Select **External** for an external trigger source.
 - Select **Video** or **Display Position** for the internal trigger source.
 6. Press the **PREV** hard key to continue setting the gated sweep.
 7. Set the gate delay by completing the following steps:
 - a. Press the **Gate Delay** soft key.
 - b. Enter a value by using the numeric keys.
 - c. Select the unit: **Sec**, **mSec**, or **µSec**.
 8. Set the gate length by completing the following steps:
 - a. Press the **Gate Length** soft key.
 - b. Enter a value by using the numeric keys.
 - c. Select the unit: **Sec**, **mSec**, or **µSec**.
 9. Press the **PREV** hard key to enable gated sweeping.
 10. Toggle the **Gated Sweep** soft key and select **On**.

NOTE

This setting is not used in the in the Spurious Emissions mode, the Field Strength mode, and the Route Map mode.

Using RF source

You can turn the RF Source feature on to provide different power levels as like using a CW signal generator.

Procedure

1. Press the **MEASURE SETUP** hot key.
2. Press the **RF Source** soft key.
3. Press the **Frequency** soft key to set the frequency of the RF source.
4. Enter a value, and then select the unit: **GHz**, **MHz**, **kHz**, or **Hz**.
5. Press the **Power Level** soft key.
6. Enter a value between -60 and 0, and then select the **dBm** soft key.
7. Toggle the **RF Source** soft key and select **On**.

Conducting spectrum measurements

If you have configured test parameters as described in the “Configuring test parameters” on page 54, your measurement is displayed on the screen as like the following example, Figure 7.

Figure 7 Spectrum measurement with spectrum analyzer



Setting trace

You can display up to six traces on the measurement chart simultaneously.

Procedure

1. Press the **TRACE/DISPLAY** hard key.
2. Press the **Select Trace** soft key, and then select the trace number: **T1**, **T2**, **T3**, **T4**, **T5**, or **T6**. The legend shape of the selected trace changes from square to round to indicate that the trace is the active one now.
3. Toggle the **Trace View** soft key and select **On**.
4. To clear, write or capture, or hide the trace(s), do one of the following:

To	Select	Trace Legend
Clear current data and display with new measurements	Clear Write	W
Display the input signal's maximum response only	Max Hold	M
Display the input signal's minimum response only	Min Hold	m
Capture the selected trace and compare traces	Capture	C
Load a saved trace	More (1/2) > Load	L
Hide the selected trace	Trace View > Off	F
Remove all the traces and initialize the trace settings	More (1/2) > Trace Clear All	

NOTE
For the **Max Hold** and **Min Hold**, the active trace compares newly acquired data with the trace shown on the screen and displays larger or smaller trace on the screen.

- To select the detection option, press the **More (1/2) > Detectors**, and then do one of the following:

To display	Select
Random noise better than the peak without missing signals	Normal
The highest value in each data point	Peak
The root mean squared average power across the spectrum	RMS
The lowest value in each data point	Negative Peak
The center value in each data point	Sample

- Optional.* Press the **More (1/2) > Trace Info** soft key, and then select the trace number to view the trace's parameter setting information stored at the time of the measurement or **None** to hide the information display.
- Optional.* If you have the two traces T1 and T2, you can perform trace math. To view the power difference between the traces, press the **T1 – T2 -> T5** or **T2 – T1 -> T6** soft key. The result is overlaid on the screen along with the second Y-axis.

NOTE
To be able to load a trace, the trace to be overlaid must be saved in the same measurement mode and frequency setting as the current measurement.

Setting limit

Procedure

To use the display line:

- Press the **LIMIT** hot key.
- Press the **Display Line** soft key for a reference line.
- Enter a value, and then press the **dBm** unit soft key.
- Toggle the **Display Line** soft key between **On** and **Off** to display and dismiss the reference line. The straight line appears across the screen to be used as a visual reference only.

To display the multiple segment line:

1. Press the **LIMIT** hot key.
 2. Press the **Multi Segment Line** soft key for Pass/Fail indication.
 3. Toggle the **Limit** soft key between **Upper** and **Lower** to select the one to be displayed.
 4. Set the number of segments for the selected upper or lower limit line. You can set up to 50 segments.
 - a. Press the **# of Line** soft key.
 - b. Enter a value between 1 and 50 by using the numeric keys.
 - c. Press the **Enter** soft key.
 5. Press the **Autoset** soft key to let the instrument set the limit for each segment and display the line.
 6. *Optional.* To move the limit line, complete the following steps:
 - a. Select **Limit Up/Down** or **Limit Left/Right**.
 - b. Turn the rotary knob to move the line as desired. You can also manually enter a value.
 7. *Optional.* To edit the segment properties, complete the following steps:
 - a. Press the **Edit Limit** soft key.
 - b. Press the **Move** soft key and then turn the rotary knob to select the segment to edit.
 - c. Select the menu option, from the following choices:
 - To hide the line for the selected segment, toggle the **Line** soft key and select **Off**.
 - To add a new point, press the **Add Point** soft key.
 - To delete the selected point, press the **Delete Point** soft key.
 - To change the position, press the **Frequency** or **Amplitude** soft key, and then turn the rotary knob to change the value as desired.
 8. *Optional.* Go to **SAVE/LOAD > Save**, and then select **Limit** to save the limit settings. See "Using save" on page 31 for more information.
-

Conducting RF measurements

Channel power

The Channel Power measurement is a common test used in the wireless industry to measure the total transmitted power of a radio within a defined frequency channel. It acquires a number of points representing the input signal in the time domain, transforms this information into the frequency domain using Fast Fourier Transform (FFT), and then calculates the channel power. The effective resolution bandwidth of the frequency domain trace is proportional to the number of points acquired for the FFT.

The channel power measurement identifies the total RF power, power spectral density, and Peak to Average Ratio (PAR) of the signal within the channel bandwidth.

Setting measure setup

After configuring test parameters, you can set the measure setup to continue your measurement. The measurement settings can be saved and recalled as a file. You can also use JDViewer, PC application software to configure a measure setup, save as a file, and load the file on to the instrument.

Procedure

1. Configure test parameters as described in the “Configuring test parameters” on page 54.
 2. Press the **MEASURE SETUP** hot key.
 3. Set the channel power measurement bandwidth to be measured:
 - a. Press the **Integrated BW** soft key.
 - b. Enter a bandwidth by using the numeric keys. You can also use the rotary knob.
 - c. Select the unit: **GHz**, **MHz**, **kHz**, or **Hz**.
 4. Set the frequency range over which the instrument will sweep:
 - a. Press the **Span** soft key.
 - b. Enter a span frequency value by using the numeric keys. You can also use the rotary knob.
 - c. Select the unit: **GHz**, **MHz**, **kHz**, or **Hz**.
 5. Set the number of measurements to be averaged:
 - a. Press the **Average** soft key.
 - b. Enter a value between 1 and 100.
 - c. Press the **Enter** soft key.
-

Setting limit

Procedure

1. Press the **LIMIT** hot key.
 2. Press the **Channel Power** soft key to set the limit parameters.
 3. Toggle the **Test Limits** soft key between **On** and **Off** to enable or disable the Pass/Fail indication.
 4. Set the upper threshold:
 - a. Press the **High Limit** soft key.
 - b. Enter a value for the upper limit.
 - c. Press the **dBm** unit soft key.
 5. Set the lower threshold:
 - a. Press the **Low Limit** soft key.
 - b. Enter a value for the lower limit.
 - c. Press the **dBm** unit soft key.
 6. *Optional.* Go to **SAVE/LOAD > Save**, and then select the save option from the choices available for your measurement mode. See “Using save” on page 31 for more information.
-

Measurement example

Figure 8 Channel power measurement with spectrum analyzer

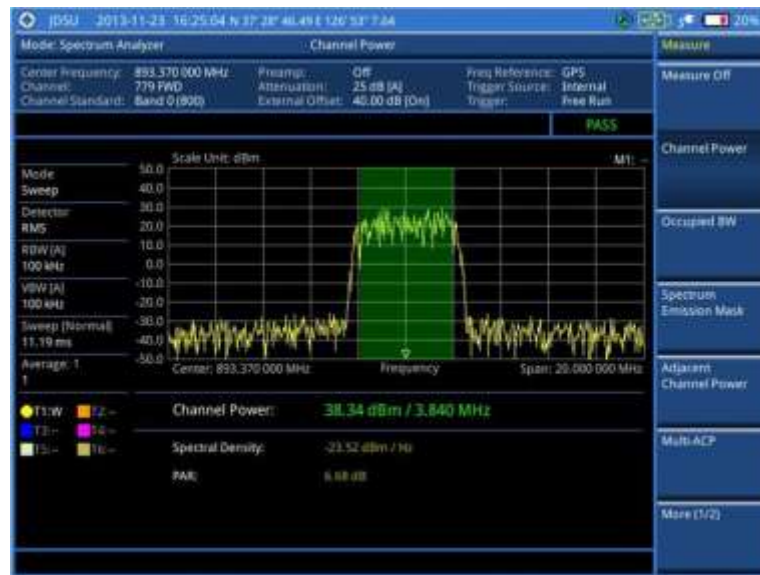

Channel power measurement result shows channel power and spectrum density in a user specified channel bandwidth. The peak to average ratio (PAR) is shown at the bottom of the screen as well. The shaded area on the display indicates the channel bandwidth.

Occupied bandwidth

The Occupied Bandwidth measures the percentage of the transmitted power within a specified bandwidth. The percentage is typically 99%.

Setting measure setup

After configuring test parameters, you can set the measure setup to continue your measurement. The measurement settings can be saved and recalled as a file. You can also use JDViewer, PC application software to configure a measure setup, save as a file, and load the file on to the instrument.

Procedure

1. Configure test parameters as described in the “Configuring test parameters” on page 54.
2. Press the **MEASURE SETUP** hot key.
3. Set the percentage of power within the bandwidth to be measured:
 - a. Press the **Occupied BW % Power** soft key.
 - b. Enter a value by using the numeric keys. You can also use the rotary knob.
 - c. Press the **Enter** soft key.
4. Set the frequency range over which the instrument will sweep:
 - a. Press the **Span** soft key.
 - b. Enter a span frequency value by using the numeric keys. You can also use the rotary knob.
 - c. Select the unit: **GHz**, **MHz**, **kHz**, or **Hz**.
5. Set the number of measurements to be averaged:

- a. Press the **Average** soft key.
- b. Enter a value between 1 and 100.
- c. Press the **Enter** soft key.

Setting limit

Procedure

1. Press the **LIMIT** hot key.
2. Press the **Occupied BW** soft key to set the limit parameters.
3. Toggle the **Test Limits** soft key between **On** and **Off** to enable or disable the Pass/Fail indication.
4. Set the upper threshold:
 - a. Press the **High Limit** soft key.
 - b. Enter a value for the upper limit.
 - c. Select the unit: **MHz**, **kHz**, or **Hz**.
5. *Optional.* Go to **SAVE/LOAD > Save**, and then select **Limit** to save the limit settings. See "Using save" on page 31 for more information.

Measurement example

The Occupied Bandwidth measurement shows both of power across the band and power bandwidth in a user specified percentage to determine the amount of spectrum used by a modulated signal. Occupied bandwidth is typically calculated as the bandwidth containing 99% of the transmitted power.

Figure 9 Occupied bandwidth measurement with spectrum analyzer



Spectrum emission mask (SEM)

The Spectrum Emission Mask (SEM) measurement is to identify and determine the power level of out-of-band spurious emission outside the necessary channel bandwidth and modulated signal. It measures the power ratio between in-band and adjacent channels. The JD780A series indicates either Pass or Fail based on the specified limit of the signal.

Setting measure setup

After configuring test parameters, you can set the measure setup to continue your measurement. The measurement settings can be saved and recalled as a file. You can also use JDViewer, PC application software to configure a measure setup, save as a file, and load the file on to the instrument.

Procedure

1. Configure test parameters as described in the “Configuring test parameters” on page 54.
 2. Press the **MEASURE SETUP** hot key.
 3. Set the main channel bandwidth to be measured:
 - a. Press the **Main Channel BW** soft key.
 - b. Enter a value by using the numeric keys. You can also use the rotary knob.
 - c. Select the unit: **MHz**, **kHz**, or **Hz**.
 4. Set the frequency range over which the instrument will sweep:
 - a. Press the **Span** soft key.
 - b. Enter a span frequency value by using the numeric keys. You can also use the rotary knob.
 - c. Select the unit: **GHz**, **MHz**, **kHz**, or **Hz**.
 5. Set the number of measurements to be averaged:
 - a. Press the **Average** soft key.
 - b. Enter a value between 1 and 100.
 - c. Press the **Enter** soft key.
 6. To configure an offset, up to five, complete the following steps:
 - a. Press the **Offset/Limit** soft key.
The Offset/Limit screen menu bar appears.
 - b. Press the **Offset** soft key, and then select the number for the active offset to configure.
 - c. Toggle the **Offset** soft key and select **On** to display or **Off** to hide the active offset.
 - d. Press the **Offset Frequency** soft key to set the center frequency of the offset.
 - e. Enter a value by using the numeric keys. You can also use the rotary knob.
 - f. Select the unit: **MHz**, **kHz**, or **Hz**.
 - g. Press the **Measurement Bandwidth** soft key to set the bandwidth for the selected offset.
 - h. Enter a value by using the numeric keys. You can also use the rotary knob.
 - i. Select the unit: **MHz**, **kHz**, or **Hz**.
 - j. Toggle the **Reference** soft key between Relative and Absolute and select **Relative** or **Absolute** depending on how to use the reference.
 7. To define the selected offset's limits for Pass/Fail indication, complete the following steps:
 - a. Press the **Start Offset Limit** soft key to set the threshold for the power difference between the main channel bandwidth and the selected offset bandwidth on the left.
 - b. Enter a value by using the numeric keys. You can also use the rotary knob.
 - c. Select the **dB** soft key.
 - d. Press the **Stop Offset Limit** soft key to set the threshold for the power difference between the main channel bandwidth and the selected offset bandwidth on the right.
 - e. Enter a value by using the numeric keys. You can also use the rotary knob.
 - f. Select the **dB** soft key.
-

Setting limit

Procedure

1. Press the **LIMIT** hot key.
2. Press the **Spectrum Emission Mask** soft key.
3. Toggle the **Test Limits** soft key between **On** and **Off** to enable or disable the Pass/Fail indication.
4. *Optional.* Go to **SAVE/LOAD > Save**, and then select **Limit** to save the limit settings. See “Using save” on page 31 for more information.

Measurement example

Figure 10 Spectrum emission mask measurement with spectrum analyzer



Adjacent channel power (ACP)

The Adjacent Channel Power (ACP) is the power contained in a specified frequency channel bandwidth relative to the total carrier power. It may also be expressed as a ratio of power spectral densities between the carrier and the specified offset frequency band.

Setting measure setup

After configuring test parameters, you can set the measure setup to continue your measurement. The measurement settings can be saved and recalled as a file. You can also use JDViewer, PC application software to configure a measure setup, save as a file, and load the file on to the instrument.

Procedure

1. Configure test parameters as described in the “Configuring test parameters” on page 54.
2. Press the **MEASURE SETUP** hot key.
3. Set the main channel bandwidth to be measured:

-
- a. Press the **Main Channel BW** soft key.
 - b. Enter a value by using the numeric keys. You can also use the rotary knob.
 - c. Select the unit: **MHz**, **kHz**, or **Hz**.
4. Set the frequency range over which the instrument will sweep:
 - a. Press the **Span** soft key.
 - b. Enter a span frequency value by using the numeric keys. You can also use the rotary knob.
 - c. Select the unit: **GHz**, **MHz**, **kHz**, or **Hz**.
 5. Set the number of measurements to be averaged:
 - a. Press the **Average** soft key.
 - b. Enter a value between 1 and 100.
 - c. Press the **Enter** soft key.
 6. To configure an offset, up to five, complete the following steps:
 - a. Press the **Offset/Limit** soft key.
The Offset/Limit screen menu bar appears.
 - b. Press the **Offset** soft key, and then select the number for the active offset to configure.
 - c. Toggle the **Offset** soft key and select **On** to display or **Off** to hide the active offset.
 - d. Press the **Offset Frequency** soft key to set the center frequency of the offset.
 - e. Enter a value by using the numeric keys. You can also use the rotary knob.
 - f. Select the unit: **MHz**, **kHz**, or **Hz**.
 - g. Press the **Integration Bandwidth** soft key to set the bandwidth for the selected offset.
 - h. Enter a value by using the numeric keys. You can also use the rotary knob.
 - i. Select the unit: **MHz**, **kHz**, or **Hz**.
 7. To define the selected offset's limits for Pass/Fail indication, complete the following steps:
 - a. Press the **Lower** soft key to set the threshold for the power difference between the main channel bandwidth and the selected offset bandwidth on the left.
 - b. Enter a value by using the numeric keys. You can also use the rotary knob.
 - c. Select the **dBc** soft key.
 - d. Press the **Upper** soft key to set the threshold for the power difference between the main channel bandwidth and the selected offset bandwidth on the right.
 - e. Enter a value by using the numeric keys. You can also use the rotary knob.
 - f. Select the **dBc** soft key.
-

Setting limit

Procedure

1. Press the **LIMIT** hot key.
 2. Press the **ACP** soft key.
 3. Toggle the **Test Limits** soft key between **On** and **Off** to enable or disable the Pass/Fail indication.
 4. *Optional.* Go to **SAVE/LOAD > Save**, and then select **Limit** to save the limit settings. See "Using save" on page 31 for more information.
-

Measurement example

Figure 11 Adjacent channel power measurement with spectrum analyzer



Multi-ACP

The Multi-ACP measurement is used to do multi-channel ACP testing. It helps you to measure ACP in multi-channel transmitting base station environment.

Setting measure setup

After configuring test parameters as described in “Configuring test parameters” on page 54, you can set the measure setup to continue your measurement. The measurement settings can be saved and recalled as a file. You can also use JDViewer, PC application software to configure a measure setup, save as a file, and load the file on to the instrument.

Procedure

1. Press the **MEASURE SETUP** hot key.
2. Toggle the **Unit** soft key and select **Freq** or **Channel**.
 - For the frequency setting, complete the following steps:
 - a. Press the **Lowest Frequency** soft key.
 - b. Enter a value by using the numeric keys. You can also use the rotary knob.
 - c. Select the unit: **GHz**, **MHz**, **kHz**, or **Hz**.
 - d. Press the **Highest Frequency** soft key.
 - e. Enter a value by using the numeric keys. You can also use the rotary knob.
 - f. Select the unit: **GHz**, **MHz**, **kHz**, or **Hz**.
 - For the channel setting, complete the following steps:
 - a. Press the **Channel Std** soft key. The standard channel window appears.
 - b. Select the band to be measured by using the rotary knob or the **Page p/Page Down** soft keys.
 - c. Press the **Select** soft key or the rotary knob to confirm the selection.

- d. Toggle the **Link** soft key to select the sweep direction and select **Fwd** or **Rev** as needed.
 - e. Press the **Lowest Channel** soft key.
 - f. Enter a value by using the numeric keys.
 - g. Press the **Enter** soft key or **ENTER** hard key to complete the entry.
The instrument automatically displays the corresponding center frequency value for the selected channel number.
 - h. Press the **Highest Channel** soft key.
 - i. Enter a value by using the numeric keys.
 - j. Press the **Enter** soft key or **ENTER** hard key to complete the entry.
The instrument automatically displays the corresponding center frequency value for the selected channel number.
3. To set up ACP setting, press the **ACP Settings** soft key and then complete the following steps:
 - a. Press the **Main Channel BW** soft key.
 - b. Enter a value by using the numeric keys. You can also use the rotary knob.
 - c. Select the unit: **MHz**, **kHz**, or **Hz**.
 - d. Press the **Span** soft key to set the frequency range over which the instrument will sweep.
 - e. Enter a span frequency value by using the numeric keys. You can also use the rotary knob.
 - f. Select the unit: **GHz**, **MHz**, **kHz**, or **Hz**.
 - g. Press the **Average** soft key to set the number of measurement to be averaged:
 - h. Enter a value between 1 and 100.
 - i. Press the **Enter** soft key.
 4. To configure an offset, up to five, complete the following steps:
 - a. Press the **Offset/Limit** soft key. The Offset/Limit screen menu bar appears.
 - b. Press the **Offset** soft key, and then select the number for the active offset to configure.
 - c. Toggle the **Offset** soft key and select **On** to display or **Off** to hide the active offset.
 - d. Press the **Offset Frequency** soft key to set the offset frequency.
 - e. Enter a value by using the numeric keys. You can also use the rotary knob.
 - f. Select the unit: **MHz**, **kHz**, or **Hz**.
 - g. Press the **Integration Bandwidth** soft key.
 - h. Enter a value by using the numeric keys. You can also use the rotary knob.
 - i. Select the unit: **MHz**, **kHz**, or **Hz**.
 5. To define the selected offset's limits for Pass/Fail indication, complete the following steps:
 - a. Press the **Lower** soft key to set the threshold for the power difference between the main channel bandwidth and the selected offset bandwidth on the left.
 - b. Enter a value by using the numeric keys. You can also use the rotary knob.
 - c. Select the **dBc** soft key.
 - d. Press the **Upper** soft key to set the threshold for the power difference between the main channel bandwidth and the selected offset bandwidth on the right.
 - e. Enter a value by using the numeric keys. You can also use the rotary knob.
 - f. Select the **dBc** soft key.
-

Setting limit

Procedure

1. Press the **LIMIT** hot key.
2. Press the **Multi-ACP** soft key.
3. Toggle the **Test Limits** soft key between **On** and **Off** to enable or disable the Pass/Fail indication.
4. *Optional.* Go to **SAVE/LOAD > Save**, and then select **Limit** to save the limit settings. See “Using save” on page 31 for more information.

Measurement example

Figure 12 Multi-ACP measurement with spectrum analyzer



Spurious emissions

The Spurious Emissions measurement is to identify or determine the power level of in-band or out-of-band spurious emissions within the necessary channel bandwidth and modulated signal. The JD780A series indicates either Pass or Fail based on the specified limit of the signal.

Setting measure setup

After configuring test parameters as described in the “Configuring test parameters” on page 54, you can set the measure setup to continue your measurement. The measurement settings can be saved and recalled as a file. You can also use JDViewer, PC application software to configure a measure setup, save as a file, and load the file on to the instrument.

Procedure

1. Press the **MEASURE SETUP** hot key.
2. To set up the range table, complete the following steps:
 - a. Press the **Range Table** soft key.
 - b. Press the **Range** soft key, and then enter the range number to add a new range or change an existing one.

-
- c. Press the **Enter** soft key.
 - d. Press the **Start Frequency** soft key to set up the frequency range.
 - e. Enter a value by using the numeric keys. You can also use the rotary knob.
 - f. Select the unit: **GHz**, **MHz**, **kHz**, or **Hz**.
 - g. Press the **Stop Frequency** soft key to set up the frequency range.
 - h. Enter a value by using the numeric keys. You can also use the rotary knob.
 - i. Select the unit: **GHz**, **MHz**, **kHz**, or **Hz**.
3. Toggle the **Range** soft key between **On** and **Off** to display or hide the selected range.
 4. To set up the test limits for Pass/Fail indication, complete the following steps:
 - a. Press the **Start Limit** soft key.
 - b. Enter a value by using the numeric keys. You can also use the rotary knob.
 - c. Select the **dBm** soft key.
 - d. Press the **Stop Limit** soft key.
 - e. Enter a value by using the numeric keys. You can also use the rotary knob.
 - f. Select the **dBm** soft key.
 5. To set up the other parameters, complete the following steps:
 - a. Select **More (1/2) > Attenuation** to set up the attenuation value.
 - b. Enter a value in the multiple of five.
 - c. Press the **dB** soft key or the **ENTER** hard key.
 - d. Press the **RBW** soft key.
 - e. Enter a value by using the numeric keys.
 - f. Select the unit: **GHz**, **MHz**, **kHz**, or **Hz**.
 - g. Press the **VBW** soft key.
 - h. Enter a value by using the numeric keys.
 - i. Select the unit: **GHz**, **MHz**, **kHz**, or **Hz**.
 6. Toggle the **Measure Type** soft key between **Examine** and **Full** to select the measurement type.

NOTE

The **Examine** mode displays only the selected range while the **Full** mode lets the instrument automatically changes the selected range from one another.

7. Set the number of measurements to be averaged:
 - a. Press the **Average** soft key.
 - b. Enter a value between 1 and 100.
 - c. Press the **Enter** soft key.
-

Setting limit

Procedure

1. Press the **LIMIT** hot key.
 2. Press the **Spurious Emissions** soft key.
 3. Toggle the **Test Limits** soft key between **On** and **Off** to enable or disable the Pass/Fail indication.
 4. *Optional.* Go to **SAVE/LOAD > Save**, and then select **Limit** to save the limit settings. See "Using save" on page 31 for more information.
-

Measurement example

Figure 13 Spurious emissions measurement with spectrum analyzer



AM/FM audio demodulation

The AM/FM Audio Demodulator operates using the power received from radio waves and it serves as an alternative to identify interfering signals easily. The instrument sounds demodulated signals that can be heard through the built-in speaker or plugged-in headphones. You can hear the sound and identify interfering signals easily.

Setting measure setup

After configuring test parameters as described in the “Configuring test parameters” on page 54, you can set the measure setup to continue your measurement. The measurement settings can be saved and recalled as a file. You can also use JDViewer, PC application software to configure a measure setup, save as a file, and load the file on to the instrument.

Procedure

1. Press the **MEASURE SETUP** hot key.
2. Toggle the **Audio Demod** soft key between **On** and **Off** to turn the AM/FM audio demodulation on and off.
3. Press the **Demod at** soft key, and then select the marker number for the frequency to be demodulated.

NOTE

You must set the marker(s) first by using the **MARKER** hard key as the AM/FM demodulator uses the marker position to demodulate. See “Using marker” on page 49 for more information.

4. Press the **Demod Mode** soft key, and then select the demodulation mode: **AM**, **FM** and **CW**.
5. Press the **Dwell Time** soft key, and then turn the rotary knob to set the demodulation interval between 1 and 20.
6. Press the **Volume** soft key, and then turn the rotary knob to set the speaker volume.

-
7. Toggle the **Auto Gain** soft key between **On** and **Off** to enable or disable the automatic gain feature to adjust the interval gain of the demodulator.
 8. *Optional.* You can use the **Save On Event** soft key to let the instrument automatically save measurement screen or result that falls outside the defined limit settings or the Fail indicator is on. You can also set to save the first event and hold the measurement or to save all the events continuously. See “Using save” on page 31 for more information.
-

Setting limit

You can show or hide the display line on the screen that is used as a visual reference only.

Procedure

To view the display line:

1. Press the **LIMIT** hot key.
2. Press the **Display Line** soft key.
3. Enter a value, and then press the **dBm** unit soft key.
4. Toggle the **Display Line On/Off** soft key and select **On**. The straight line appears on the screen.

To dismiss the display line:

1. Press the **LIMIT** hot key.
 2. Toggle the **Display Line On/Off** soft key and select **Off**.
-

You can use the multiple segment limit line to set up different limits for different frequency ranges for Pass/Fail indication.

Procedure

To display the multiple segment line:

1. Press the **LIMIT** hot key.
 2. Press the **Multi Segment Line** soft key.
 3. Toggle the **Limit** soft key between **Upper** and **Lower** to select the one to be displayed.
 4. Set the number of segments for the selected upper or lower limit line. You can set up to 50 segments.
 - a. Press the **# of Line** soft key.
 - b. Enter a value between 1 and 50 by using the numeric keys.
 - c. Press the **Enter** soft key.
 5. Press the **Autoset** soft key to let the instrument set the limit for each segment and display the line.
 6. *Optional.* To move the limit line, complete the following steps:
 - a. Select **Limit Up/Down** or **Limit Left/Right**.
 - b. Turn the rotary knob to move the line as desired. You can also manually enter a value.
 7. *Optional.* To edit the segment properties, complete the following steps:
 - a. Press the **Edit Limit** soft key.
 - b. Press the **Move** soft key and then turn the rotary knob to select the segment to edit.
 - c. Select the menu option, from the following choices:
-

- To hide the line for the selected segment, toggle the **Line** soft key and select **Off**.
 - To add a new point, press the **Add Point** soft key.
 - To delete the selected point, press the **Delete Point** soft key.
 - To change the position, press the **Frequency** or **Amplitude** soft key, and then turn the rotary knob to change the value as desired.
8. *Optional.* Go to **SAVE/LOAD > Save**, and then select **Limit** to save the limit settings. See “Using save” on page 31 for more information.

Measurement example

Figure 14 AM/FM audio demodulation with spectrum analyzer



Field strength meter

The Field Strength Meter measures the field strength over the frequency range of a connected antenna, which is known with its specific bandwidth and gain characteristics. A standard or user-defined antenna can be selected from the antenna list in the JD780A series.

Setting measure setup

Procedure

1. Connect an antenna to be used with your instrument.
2. Configure test parameters as described in the “Configuring test parameters” on page 54.
3. Press the **MEASURE SETUP** hot key, and then do one of the following:
 - To select the connected antenna from the list stored in the instrument:
 - a. Press the **Antenna List** soft key to view the standard and custom antennas. The antenna list window appears.
 - b. Select an antenna to be used for the field strength measurement by using the rotary knob, the arrow keys, or **Page Up/Page Down** soft keys.
 - c. Press the **Select** soft key.

NOTE

You can use the JDViewer to edit or define a custom antenna and add to this list.

- To edit the properties of the connected antenna:
 - a. Press the **Antenna Start Frequency** soft key.
 - b. Enter a value by using the numeric keys, and then select the unit: **GHz, MHz, kHz, or Hz**. You can also use the rotary knob.
 - c. Press the **Antenna Stop Frequency** soft key.
 - d. Enter a value by using the numeric keys, and then select the unit: **GHz, MHz, kHz, or Hz**. You can also use the rotary knob.
 - e. Press the **Gain** soft key to enter the gain information for the antenna.
 - f. Enter a value by using the numeric keys, and then select the **Enter** soft key.

Setting limit

You can show or hide the display line on the screen that is used as a visual reference only.

Procedure

To view the display line:

1. Press the **LIMIT** hot key.
2. Press the **Display Line** soft key.
3. Enter a value, and then press the **dBm** unit soft key.
4. Toggle the **Display Line On/Off** soft key and select **On**.
The straight line appears on the screen.

To dismiss the display line:

1. Press the **LIMIT** hot key.
 2. Toggle the **Display Line On/Off** soft key and select **Off**.
-

You can use the multiple segment limit line to set up different limits for different frequency ranges for Pass/Fail indication.

Procedure

To display the multiple segment line:

1. Press the **LIMIT** hot key.
 2. Press the **Multi Segment Line** soft key.
 3. Toggle the **Limit** soft key between **Upper** and **Lower** to select the one to be displayed.
 4. Set the number of segments for the selected upper or lower limit line. You can set up to 50 segments.
 - a. Press the **# of Line** soft key.
 - b. Enter a value between 1 and 50 by using the numeric keys.
 - c. Press the **Enter** soft key.
 5. Press the **Autoset** soft key to set and display the limit line for each segment automatically..
 6. *Optional.* To move the limit line, complete the following steps:
 - a. Select **Limit Up/Down** or **Limit Left/Right**.
 - b. Turn the rotary knob to move the line as desired. You can also manually enter a value.
-

7. *Optional.* To edit the segment properties, complete the following steps:
 - a. Press the **Edit Limit** soft key.
 - b. Press the **Move** soft key and then turn the rotary knob to select the segment to edit.
 - c. Select the menu option, from the following choices:
 - To hide the line for the selected segment, toggle the **Line** soft key and select **Off**.
 - To add a new point, press the **Add Point** soft key.
 - To delete the selected point, press the **Delete Point** soft key.
 - To change the position, press the **Frequency** or **Amplitude** soft key, and then turn the rotary knob to change the value as desired.
8. *Optional.* Go to **SAVE/LOAD > Save**, and then select **Limit** to save the limit settings. See “Using save” on page 31 for more information.

Measurement example

Figure 15 Field strength measurement with spectrum analyzer



Route map

The JD780A Series provides indoor and outdoor mapping function that allows a user to collect data of points in an indoor or outdoor environment and track the received signals and coverage of RF transmitters plotting real time directly on top of a loaded floor plan or a map.

Setting measure setup

Procedure

1. If required, connect a GPS receiver to your JD780A series for outdoor mapping. Indoor mapping does not necessarily need a GPS antenna.
2. Configure test parameters as described in the “Configuring test parameters” on page 54.
3. To load your map file, complete the following steps:
 - a. Plug in your USB drive that has a floor map or `.mcf` file type created in JDMaCreator.

NOTE

The JDMapCreator converts and resizes any scanned floor plan or layout to fit onto your instrument's display. You must save your map files (.mcf) into the "SavedMap" folder of your USB drive so that you can load them onto your instrument.

- b. Press **SAVE/LOAD** hot key, and then select **Load > Load Map**. See "Using load" on page 34 for more information.
- 4. Press the **MEASURE SETUP** hot key.
- 5. Press the **Plot Point** soft key, and then select the plot point option from the following choices:
 - To collect data/plot points automatically as you move around in a vehicle or outside, select **GPS** and then toggle the **Screen Mode** soft key between **Map** and **Full**.

NOTE

With the **Map** setting, you can view only the collected points that can be seen within the boundary of the loaded map. If a point is off the map, the instrument displays an arrow to indicate the direction of the current location on the map and the distance from the center to the location at the top of the screen.

With the **Full** setting, you can view all the collected points of the route without the loaded map.

- To collect data/plot points manually without a GPS antenna, select **Position**.
- To collect data/plot points based on time, select **Time**.
You do not need a GPS antenna as you would usually use this option indoor.
- 6. Press the **Plot Item** soft key, and then select the measurement option: **RSSI** or **ACP**.
- 7. *Optional.* If ACP is selected, set the **Main Channel BW** and **Offset/Limit** :
 - a. Press the **Main Channel BW** soft key.
 - b. Enter a value by using the numeric keys. You can also use the rotary knob.
 - c. Select the unit: **MHz**, **kHz**, or **Hz**.
 - d. Press the **Offset/Limit** soft key.
 - e. Toggle the **Offset** soft key and select **On** to display or **Off** to hide the offset.
 - f. Press the **Integration Bandwidth** soft key.
 - g. Enter a value by using the numeric keys. You can also use the rotary knob.
 - h. Select the unit: **MHz**, **kHz**, or **Hz**.
 - i. Press the **Offset Frequency** soft key to set the offset frequency.
 - j. Enter a value by using the numeric keys. You can also use the rotary knob.
 - k. Select the unit: **MHz**, **kHz**, or **Hz**.
 - l. Press the **Offset Limit** soft key to set the offset limit.
 - m. Enter a value by using the numeric keys. You can also use the rotary knob.
 - n. Select the **dB** soft key.
- 8. Toggle the **Plot** soft key and select **Start**.
- 9. Touch directly on the screen or press the **ENTER** hard key to collect data and plot points on the loaded map for the **Position** or **Time** setting.

NOTE

For the **Position** setting, you can change the direction of the route with screen touch or the arrow keys and the distance with the rotary knob. For the **Time** setting, the instrument interpolates points in between two enters on a straight dotted line. You can change the direction of the route with the arrow keys and the distance with the rotary knob.

- 10. Toggle the **Plot** soft key and select **Stop** to stop plotting.
- 11. Press the **SAVE/LOAD** hot key to save the result. See "Using save" on page 31 for more

information.

NOTE

The instrument does not automatically save the collected data. It is recommended that you save the result. Otherwise, you will lose all the collected data.

Setting limit

You can set the thresholds for the four different color indicators.

Procedure

1. Press the **LIMIT** hot key.
2. Press the **Excellent** soft key to set its threshold.
3. Enter a value, and then press the **dBm** soft key. You can also use the rotary knob.
4. Press the **Very Good** soft key to set its threshold.
5. Enter a value, and then press the **dBm** soft key. You can also use the rotary knob.
6. Press the **Good** soft key to set its threshold.
7. Enter a value, and then press the **dBm** soft key. You can also use the rotary knob.
8. Press the **Poor** soft key to set its threshold.
9. Enter a value, and then press the **dBm** soft key. You can also use the rotary knob.
10. *Optional.* Go to **SAVE/LOAD > Save**, and then select **Limit** to save the limit settings. See "Using save" on page 31 for more information.

Measurement example

Figure 16 Route map measurement screen with GPS



Dual spectrum

The Dual Spectrum feature lets you view two spectrum measurements, both the Uplink and Downlink spectrum, simultaneously eliminating the need to swap between two screens back and forth.

Setting measure setup

Procedure

1. Configure test parameters as described in the “Configuring test parameters” on page 54.
2. Press the **MEASURE SETUP** hot key.
3. Toggle the **Active Window** soft key between **Top** and **Bottom** to select the measurement window to configure or work on.

Measurement example

Figure 17 Dual spectrum measurement with spectrum analyzer



PIM detection (single and multiple carriers)

The Passive Intermodulation (PIM) Detection allows you to detect Uplink PIM across the full spectrum for any technology. When PIM is detected, the normal repair mode is to replace the offending cable and what you need to do is replacing the whole cable irrespective of the location of the fault.

Setting measure setup

Procedure

1. Press the **MEASURE SETUP** hot key.
2. Connect cables as instructed on the screen.
3. *Optional.* To check any possibility of PIM existence in red color by calculation, complete the following steps:
 - a. Press the **Calculated PIM** soft key.
 - b. Press the **Radio Band** soft key for single carrier. There are **Radio 1 Band** and **Radio 2 Band** soft keys for multiple carriers.
 - c. Highlight a desired band and then press the **Select** soft key.
 - d. Press the **Return** soft key.

4. To set the uplink frequency to be measured, do one of the following:
 - To set the center frequency and span, complete the following steps:
 - a. Toggle the **Unit** soft key and select **Freq.**
 - b. Press the **Uplink Center Frequency** soft key.
 - c. Enter a value by using the numeric keys. You can also use the rotary knob.
 - d. Select the unit: **GHz, MHz, kHz, or Hz.**
 - e. Press the **Uplink Span** soft key.
 - f. Enter a value by using the numeric keys. You can also use the rotary knob.
 - g. Select the unit: **GHz, MHz, kHz, or Hz.**
 - To set the channel number and span, complete the following steps:
 - a. Toggle the **Unit** soft key and select **Channel.**
 - b. Press the **Channel Std** soft key and select a desired band.
 - c. Press the **Channel Number** soft key.
 - d. Enter a value by using the numeric keys and then press the **Enter** soft key. The instrument automatically displays the corresponding center frequency value for the selected channel number.
 - e. Press the **Uplink Span** soft key.
 - f. Enter a value by using the numeric keys. You can also use the rotary knob.
 - g. Select the unit: **GHz, MHz, kHz, or Hz.**
5. Press the **Continue** soft key and follow the instructions on the screen.

Measurement example

Figure 18 PIM detection for single carrier



Figure 19 PIM detection for multiple carriers



Using Interference Analyzer

This chapter provides instructions for using the Interference Analyzer function (option 011). Topics discussed in this chapter are as follows:

■ Introduction	86
■ Display overview	86
■ Connecting a cable	87
■ Selecting measurement mode	88
■ Configuring test parameters	88
■ Conducting spectrum measurements	94
■ Conducting interference measurements	96
■ Setting limit for interference analyzer	103

Introduction

Interference is becoming more prevalent in the wireless community with the increasing number of transmitters coming on the air. Wireless service providers have traditionally used spectrum analyzers to monitor service channels, frequencies, and adjacent spectrum and to locate sources of interference. A spectrum analyzer can only show you an interfering signal and you require determining the source of the interference. To solve interference problems, you must understand the RF environment, know adjacent operating transmitters, and identify any new or unlicensed emitters.

Once a potential interfering signal is identified in the Spectrum Analyzer mode, you can monitor the signal further in the Interference Analyzer mode. JD780A series provides two different methodologies to identify and determine interference signals: Spectrogram and Received Signal Strength Indicator (RSSI). Locating the source of interference signal can be done with geographical information received from built-in GPS receiver.

The JD780A series is extremely effective for locating and identifying periodic or intermittent RF interference. Interference signals derive from several kinds of licensed or unlicensed transmitters that cause dropped calls and poor service quality.

The JD780A series provides following measurements for interference analysis:

- Spectrum
- Spectrogram (Single/Dual)
- RSSI (Received Signal Strength Indicator)
- Interference Finder
- Spectrum Replayer

Display overview

Figure 20 provides descriptions for each segment of the measurement screen.

Figure 20 Interference measurement screen

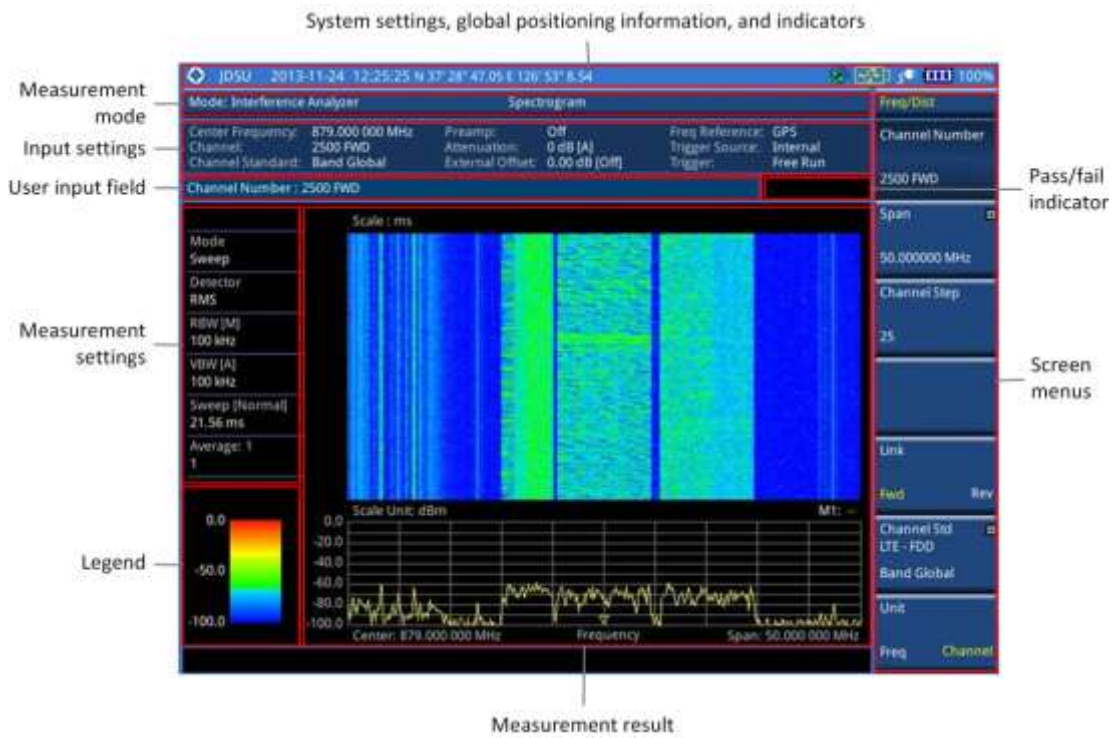

Connecting a cable

Procedure

1. Connect an Omni/directional RF antenna to the **Spectrum Analyzer RF In** port of the JD780A series.
2. Connect a GPS antenna to the **GPS** port of the JD780A series.

Figure 21 Interference measurement connection

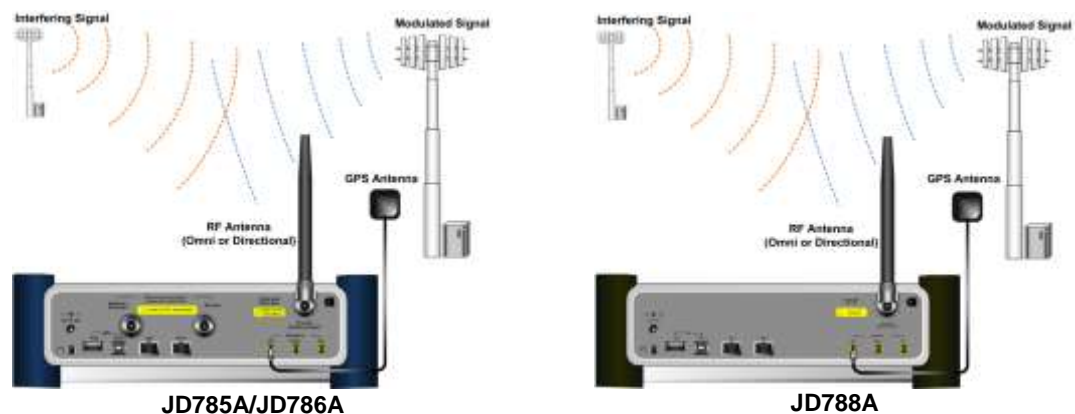

CAUTION

If the input signal level to be measured is less than 0 dBm, set it to 0 dB attenuation or turn on the preamp to have better dynamic range for the testing.

Selecting measurement mode

Procedure

1. Press the **MODE** hard key.
 2. Press the **Interference Analyzer** soft key. The **Spectrum** mode is selected by default.
 3. To change the mode, press the **MEASURE** hot key and then select the measurement mode: **Spectrogram**, **Dual Spectrogram**, **RSSI**, **Interference Finder**, or **Spectrum Replayer**.
-

NOTE

If the **Dual Spectrogram** is selected, you can select the left or right measurement pane under **MEASURE SETUP** to configure measurement parameters for the selected spectrogram.

Configuring test parameters

Setting frequency

You need to set the frequency range to be measured either with the center frequency and span or with the start and stop frequencies. You can also set the frequency with the channel number and span.

Procedure

To set the center frequency and span:

1. Press the **FREQ/DIST** hard key.
2. Toggle the **Unit** soft key and select **Freq**.
3. Press the **Center Frequency** soft key.
4. Enter a value by using the numeric keys. You can also use the rotary knob or the arrow keys.
5. Select the unit: **GHz**, **MHz**, **kHz**, or **Hz**.
6. Press the **Span** soft key, and then do one of the following:
 - To set the span manually, select **Span**, enter a value, and then select the unit.
 - To set the span automatically, select **Full Span**, **Zero Span**, or **Last Span** as needed.

NOTE

The **Zero Span** option is available only in the Spectrum mode. If you have selected **Zero Span**, select **TRIGGER > Free Run**, **External**, **GPS**, **Video**, or **Display Position**.

To set the start and stop frequencies:

1. Press the **FREQ/DIST** hard key.
2. Toggle the **Unit** soft key and select **Freq**.
3. Press the **Start Frequency** soft key.
4. Enter a value by using the numeric keys. You can also use the rotary knob or the arrow keys.
5. Select the unit: **GHz**, **MHz**, **kHz**, or **Hz**.
6. Press the **Stop Frequency** soft key.
7. Enter a value by using the numeric keys. You can also use the rotary knob or the arrow keys.
8. Select the unit: **GHz**, **MHz**, **kHz**, or **Hz**.

To set the channel number and span:

1. Press the **FREQ/DIST** hard key.
2. Toggle the **Unit** soft key and select **Channel**.
3. To select the standard channel, complete the following steps:
 - a. Press the **Channel Std** soft key. The standard channel window appears. See "Appendix C – Band, frequency & channel standard" on page 541 for more information.
 - b. Select the band to be measured by using the rotary knob, the arrow keys, or the **Page Up/Page Down** soft keys.
 - c. Press the **Select** soft key or the rotary knob to confirm the selection.
4. Toggle the **Link** soft key to select the sweep direction and select **Fwd** for forward or **Rev** for reverse.
5. To set the channel number, complete the following steps:
 - a. Press the **Channel Number** soft key.
 - b. Enter a value by using the numeric keys.
 - c. Press the **Enter** soft key or **ENTER** hard key to complete the entry. The instrument automatically displays the corresponding center frequency value for the selected channel number.
6. To set the span, complete the following steps:
 - a. Press the **Span** soft key.
 - b. Select the span option, from the following choices:
 - To set the span manually, select **Span**, enter a value, and then select the unit.
 - To set the span automatically, select **Full Span**, **Zero Span**, or **Last Span** as needed.

NOTE

The **Zero Span** option is available only in the Spectrum mode. If you have selected **Zero Span**, select **TRIGGER > Free Run, External, GPS, Video, or Display Position**.

Optional. To define the amount of frequency increment for the rotary knob:

1. Press the **Frequency Step** soft key, if the **Freq** is selected.
2. Enter a value by using the numeric keys.
3. Press the unit: **GHz**, **MHz**, **kHz**, or **Hz**.

Optional. To define the amount of channel increment for the rotary knob:

1. Press the **Channel Step** soft key, if the **Channel** is selected.
2. Enter a value by using the numeric keys.
3. Press the **Enter** soft key.

Setting amplitude

Reference level and attenuation

You can set the reference and attenuation levels automatically or manually to optimize the display of the traces measured, as you desire.

Procedure

To automatically set the reference and attenuation level:

1. Press the **AMP/SCALE** hard key.
 2. Press the **Auto Scale** soft key.
-

Each time you press this key, both of the Y-axis scale and input attenuation level change to be optimized with some margin.

To set the reference or attenuation level manually:

1. Press the **AMP/SCALE** hard key.
2. To set the maximum reference value on the Y-axis manually, complete the following steps:
 - a. Press the **Reference Level** soft key.
 - b. Enter a value by using the numeric keys or the rotary knob with 10 dB increments.
 - c. Press the **dBm** soft key or the **ENTER** hard key.
3. To set the attenuation option, select one from the following choices:
 - To set the input attenuator’s level automatically, select **Attenuation > Auto**.

NOTE

It is recommended that you set the **Attenuation** to **Auto** in most situations so that the level of the input attenuator can be set automatically according to your input signal level.

- To set the input attenuation manually up to 55 dB to optimize S/N, complete the following steps:
 - a. Select **Attenuation > Manual**.
 - b. Press the **Attenuation Value** soft key to set the level.
 - c. Enter a value between 0 and 55 in fives by using the numeric keys.
 - d. Press the **dB** soft key or the **ENTER** hard key.
- To couple the input attenuator’s level with your reference level setting, select **Attenuation > Couple**.
As you increase the reference setting, the attenuation level also increases accordingly.

Optional. To change the scale unit:

1. Select **More (1/2) > Units**.
2. Select the unit of the display scale: **dBm**, **dBV**, **dBmV**, **dBμV**, **V**, or **W**.
The scale unit on the screen changes accordingly.

Scale per division

You can use the **Scale/Div** feature available for the spectrum measurement screen. It represents the value of one division on the horizontal scale. The default setting is 10 dB per division and the maximum value can be set up to 20 dB.

Procedure

To set the scale per division:

1. Press the **AMP/SCALE** hard key.
2. Select **More (1/2) > Scale/Div**.
3. Enter a value between 1 and 20 by using the numeric keys.
4. Press the **dB** soft key to complete the entry.

Pre-amplifier

You can turn the internal pre-amplifier on to correct and compensate for the gain of the preamp so that amplitude readings show the value at the input connector.

Procedure

1. Press the **AMP/SCALE** hard key.
 2. Toggle the **Preamp** soft key and select **On** or **Off** as needed.
-

NOTE

You can turn the Preamp on when the input attenuation range is from 0 dB to 10 dB. If the attenuation value is manually set to greater than 10 dB, the instrument will automatically turn off the pre-amplifier to display low-level signal properly on the chart.

External offset

You can turn the **External Offset** on and manually set the external offset value. An offset consists of a cable loss and a user offset and the measurement result shows the value reflecting both offset values. When the external offset value is set at 40 dB in the Spectrum mode, the measurement result compensates 40 dB at both the Spectrum Analyzer and Signal Analyzer modes

Procedure

To set the external offset:

1. Press the **AMP/SCALE** hard key.
2. Toggle the **External Offset** soft key and select **On**.
3. Enter a value by using the numeric keys.
4. Press the **dB** soft key to complete the entry.

To turn the external offset off:

1. Press the **AMP/SCALE** hard key.
 2. Toggle the **External Offset** soft key and select **Off**.
-

Setting bandwidth

VBW based on the designated RBW. Selecting **Auto** changes the value to correspond to your frequency span setting for RBW and to the current RBW and VBW/RBW settings for VBW.

Procedure

To automatically set the RBW and VBW to your selected VBW/RBW ratio:

1. Press the **BW/AVG** hard key.
2. Press the **VBW/RBW** soft key to set the proportional VBW based on the designated RBW. Table 9 shows the ratio example for 30 kHz RBW.
3. Select the ratio: **1**, **0.3**, **0.1**, **0.03**, **0.01**, or **0.003**.
4. Toggle the **RBW** soft key and select **Auto**.
5. Toggle the **VBW** soft key and select **Auto**.

The RBW or VBW value on the screen changes accordingly based on the span.

To manually set the RBW or VBW to your selected VBW/RBW ratio:

1. Press the **BW/AVG** hard key.
 2. Press the **RBW** soft key.
-

3. Enter a value between 1 Hz to 3 MHz in 1-3 sequence by using the numeric keys.
 4. Select the unit: **MHz**, **kHz**, or **Hz**.
The RBW setting automatically changes to **Manual**.
 5. Press the **VBW** soft key.
 6. Enter a value by using the numeric keys.
 7. Select the unit: **MHz**, **kHz**, or **Hz**.
The VBW setting automatically changes to **Manual**.
- The RBW or VBW value on the screen changes accordingly.

Table 11 VBW/RBW ratio example

RBW	Ratio (VBW/RBW)	VBW
30 kHz	1:1	30 kHz
	1:0.3	10 kHz
	1:0.1	3 kHz
	1:0.03	1 kHz
	1:0.01	300 Hz
	1:0.003	100 Hz

Setting average

You can set the number of measurements to be averaged for the trace presentation. A maximum of 100 times of averaging can be set. When the averaging reaches to your setting, a new measurement value replaces the measurement value in sequence from the earliest.

Procedure

1. Press the **BW/AVG** hard key.
 2. Press the **Average** soft key.
 3. Enter a value between 1 and 100 as needed by using the numeric keys.
 4. Press the **Enter** soft key.
-

Setting sweep

The **SWEEP** hot key is used to set and control the sweep time, sweep mode, gated sweep settings, and gated sweep on or off.

Sweep time

You can set the sweep time automatically or manually. Manual setting allows you to set the sweep time beyond an automatic setting.

Procedure

1. Press the **SWEEP** hot key.
 2. Select the sweep time option, from the following choices:
-

-
- To automatically set, toggle the **Sweep Time** soft key and select **Auto**.
 - To manually set, complete the following steps:
 - a. Press the **Sweep Time** soft key.
 - b. Enter a value by using the numeric keys.
 - c. Select the unit: **Sec**, **mSec**, or **µSec**.
The sweep time mode automatically changes to **Manual**.
-

Sweep mode

The default settings of the sweep mode are **Continue** and **Normal** to sweep continuously at a normal speed for most on-going measurements. If you want to hold the measurement or get a single sweep, you can change the sweep mode.

Procedure

To select the single sweep mode:

1. Press the **SWEEP** hot key.
2. Toggle the **Sweep Mode** soft key and select **Single**. You can also use the **HOLD** hot key. The letter **HOLD** in red appears and the sweeping is paused.
3. *Optional.* Press the **Sweep Once** soft key to get a new measurement.

To return to the continuous sweep mode:

1. Toggle the **Sweep Mode** soft key and select **Continue**. You can also use the **HOLD** hot key. The letter **HOLD** in red disappears and the sweeping resumes.
-

NOTE

Selecting **Sweep Mode > Fast** may reduce the measurement accuracy, but you can use this fast sweep mode to identify the existence of interfering signals.

Gated sweep

You can configure the gated sweep settings with an internal or external trigger source. If you select **Gated Sweep Settings**, you can view the signal in time domain.

Procedure

1. Press the **SWEEP** hot key.
 2. Press the **Gated Sweep Settings** soft key.
 3. *Optional.* Adjust sweep time to allow enough time for a cycle by completing the following steps:
 - a. Press the **Zero Span Time** soft key.
 - b. Enter a value by using the numeric keys.
 - c. Select the unit: **Sec**, **mSec**, or **µSec**.
 4. Set the period, if using the internal trigger source, by doing one of the following:
 - To select the preset period, complete the following steps:
 - a. Toggle the **Period** soft key and select **StdSignal**.
 - b. Press the **StdSignal** soft key, and then select the period: **GSM (4.615 ms)**, **WCDMA (10 ms)**, **LTE (10 ms)**, **EV-DO (5 ms)**, **TD-SCDMA (5 ms)**, or **WiMAX (10 ms)**.
 - To manually set the period, complete the following steps:
-

- a. Toggle the **Period** soft key and select **Manual**.
 - b. Press the **Period** soft key to enter the amount of time.
 - c. Enter a value by using the numeric keys.
 - d. Select the unit: **Sec**, **mSec**, or **µSec**.
5. Press the **TRIGGER** hot key, and then do one of the following:
 - Select **External** for an external trigger source.
 - Select **Video** or **Display Position** for the internal trigger source.
 6. Press the **PREV** hard key to continue setting the gated sweep.
 7. Set the gate delay by completing the following steps:
 - a. Press the **Gate Delay** soft key.
 - b. Enter a value by using the numeric keys.
 - c. Select the unit: **Sec**, **mSec**, or **µSec**.
 8. Set the gate length by completing the following steps:
 - a. Press the **Gate Length** soft key.
 - b. Enter a value by using the numeric keys.
 - c. Select the unit: **Sec**, **mSec**, or **µSec**.
 9. Press the **PREV** hard key to enable gated sweeping.
 10. Toggle the **Gated Sweep** soft key and select **On**.

NOTE

This setting is not used in the Spectrum Replayer mode.

Conducting spectrum measurements

The spectrum measurement with an audible indicator is especially useful for locating interferer sources with a directional antenna.

Sound indicator

You can use the Sound Indicator to help you identify interfering signals by sounding an alarm.

Procedure

1. Configure test parameters as described in the “Configuring test parameters” on page 88.
 2. Press the **MEASURE SETUP** hot key.
 3. Press the **Sound Indicator** soft key.
 4. Toggle the **Sound** soft key between **On** and **Off** to enable and disable the alarm sound.
 5. Select the alarm reference option from the following choices:
 - To set the active marker position as the alarm reference, toggle the **Alarm Reference** soft key and select **Marker**.
 - To set the limit as the alarm reference, complete the following steps:
 - a. Toggle the **Alarm Reference** soft key and select **Line**.
The Limit Line menu becomes activated to be set.
 - b. Press the **Limit Line** soft key to define a threshold for the limit line.
-

-
- c. Enter a value by using the numeric keys. You can also use the rotary knob.
 - d. Press the **dBm** soft key.
6. *Optional.* To adjust the volume for alarm sound, press the **Volume** soft key and then turn the rotary knob clockwise or counter clockwise.
 7. *Optional.* You can save logging data automatically so that you can load the measurement data and replay in the Spectrum Replayer mode. See “Using save” on page 31 for more information.
-

AM/FM audio demodulation

You can use the AM/FM Audio Demodulation to identify if the interfering signal is n^{th} harmonics of AM/FM audio. The instrument sounds demodulated signals that you can hear through the speaker or headphones.

Procedure

1. Configure test parameters as described in the “Configuring test parameters” on page 88.
2. Press the **MEASURE SETUP** hot key.
3. Toggle the **Audio Demod** soft key between **On** and **Off** to turn the AM/FM audio demodulation on and off.
4. Press the **Demod at** soft key, and then select the marker number for the frequency to be demodulated.

NOTE

You must set the marker(s) first by using the **MARKER** hard key as the AM/FM demodulator uses the marker position to demodulate. See “Using marker” on page 49 for more information.

5. Press the **Demod Mode** soft key, and then select the demodulation mode: **AM**, **FM** and **CW**.
 6. Press the **Dwell Time** soft key, and then turn the rotary knob to set the demodulation interval between 1 and 20.
 7. Press the **Volume** soft key, and then turn the rotary knob to set the speaker volume.
 8. Toggle the **Auto Gain** soft key between **On** and **Off** to enable or disable the automatic gain feature to adjust the interval gain of the demodulator.
 9. *Optional.* Go to **SAVE/LOAD > Save**, and then select the save option from the choices available for your measurement mode. See “Using save” on page 31 for more information.
-

Interference ID

The Interference ID automatically classifies interfering signals over a designated spectrum and displays the list of possible signal types corresponding to the selected signal.

Procedure

1. Configure test parameters as described in the “Configuring test parameters” on page 88.
 2. Press the **MEASURE SETUP** hot key.
 3. Toggle the **Interference ID** soft key between **On** and **Off** to turn the Interference ID on and off.
 4. To set the threshold level manually, complete the following steps:
 - a. Press the **Threshold** soft key.
 - b. Enter a value by using the numeric keys.
-

- c. Press the **dBm** soft key.
5. *Optional.* Go to **SAVE/LOAD > Save**, and then select the save option from the choices available for your measurement mode. See “Using save” on page 31 for more information.

NOTE

You can use the **LIMIT** hot key to analyze your measurements with the display line, multi-segment line, and channel limit. See “Setting limit for interference analyzer” on page 103 for more information.

Conducting interference measurements

Spectrogram

The Spectrogram is particularly useful when attempting to identify periodic or intermittent signals as it captures spectrum activity over time and uses various colors to differentiate spectrum power levels. When the directional antenna is used to receive the signal, you will see a change in the amplitude of the tracked signal as you change the direction of the antenna and see a change in the Spectrogram colors. The source of the signal is located in the direction that results in the highest signal strength.

Setting measure setup

Procedure

1. Configure test parameters as described in the “Configuring test parameters” on page 88.
2. Press the **MEASURE SETUP** hot key.
3. To set the amount of time between each trace measurement:
 - a. Press the **Time Interval** soft key.
 - b. Enter a value by using the numeric keys. You can also use the rotary knob.
 - c. Press the **Sec** soft key.
4. To set the time cursor on a specific trace position, complete the following steps:
 - a. Toggle the **Time Cursor** soft key and select **On**.
 - b. Turn the rotary knob to move the time cursor. You can also enter a value and then press the **Enter** soft key.

NOTE

Enabling the time cursor puts the measurement on hold and you can make post-processing analysis for each measurement over time using the time cursor.

5. To start a new measurement, press the **Reset/Restart** soft key.
 6. *Optional.* Go to **SAVE/LOAD > Save**, and then select the save option from the choices available for your measurement mode. See “Using save” on page 31 for more information.
-

Measurement example

The spectrogram shows a vertical line on the chart when the marker is enabled on the screen.

Figure 22 Interference measurement in spectrogram

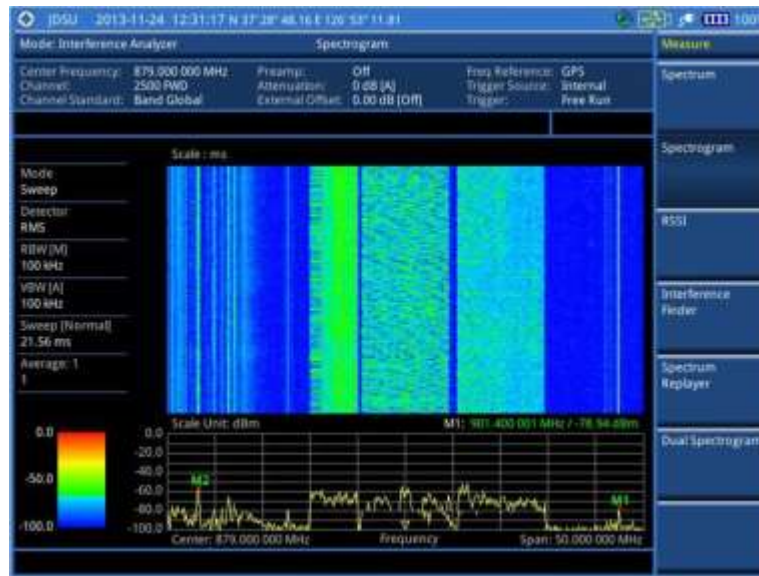

- The horizontal line or X-axis of the spectrogram is frequency.
- The vertical line or Y-axis is time.
- The color identification (Spectrogram) indicates power level of the tracked signal. As the signal strength increases, the color on the spectrogram changes accordingly.

Figure 23 Interference measurement in spectrogram with gated sweep on

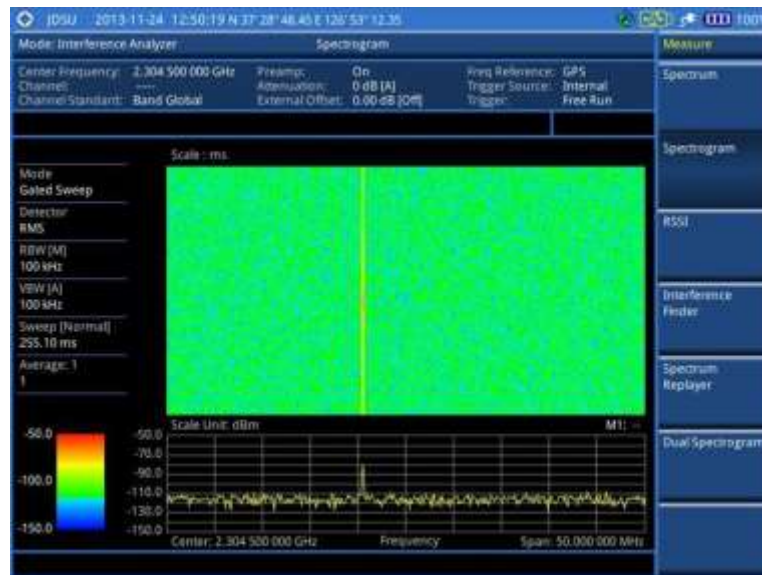

NOTE

You can use the **LIMIT** hot key to analyze your measurements with the display line, multi-segment line, and channel limit. See “Setting limit for interference analyzer” on page 103 for more information.

Dual spectrogram

The Dual Spectrogram mode is useful to compare two spectrograms displayed simultaneously on the

screen.

Setting measure setup

Procedure

1. Configure test parameters as described in the “Configuring test parameters” on page 88.
2. Press the **MEASURE SETUP** hot key.
3. Toggle the **Active Window** soft key and select **Left** or **Right** spectrogram to be set up.
4. To set the amount of time between each trace measurement:
 - a. Press the **Time Interval** soft key.
 - b. Enter a value by using the numeric keys. You can also use the rotary knob.
 - c. Press the **Sec** soft key.
5. To set the time cursor on a specific trace position, complete the following steps:
 - a. Toggle the **Time Cursor** soft key and select **On**.
 - b. Turn the rotary knob to move the time cursor. You can also enter a value and then press the **Enter** soft key.

NOTE

Enabling the time cursor puts the measurement on hold and you can make post-processing analysis for each measurement over time using the time cursor.

6. To start a new measurement, press the **Reset/Restart** soft key.
7. *Optional.* Go to **SAVE/LOAD > Save**, and then select the save option from the choices available for your measurement mode. See “Using save” on page 31 for more information.

Measurement example

Figure 24 Interference measurement in dual spectrogram view

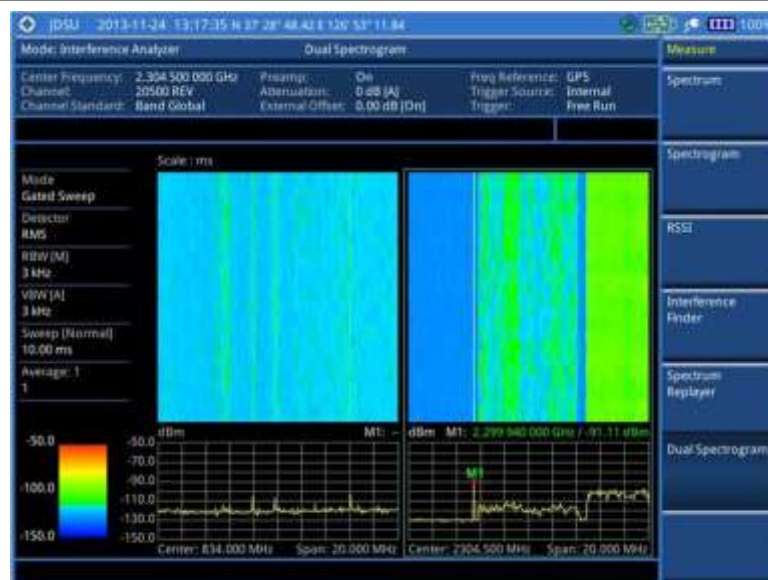

RSSI

The Received Signal Strength Indicator (RSSI) is a multi-signal tracking metric that is particularly useful for measuring power-level variations over time. The RSSI measurement lets you assign power

limit line for audible alarms and increase alarm counters every time a signal exceeds a defined limit line. For long-term analysis, the spectrogram and RSSI measurements can be automatically saved into an external USB memory. Post-analysis can be performed with JDViewer application software.

Setting measure setup

Procedure

1. Configure test parameters as described in the “Configuring test parameters” on page 88.
2. Press the **MEASURE SETUP** hot key.
3. To set up the alarm parameters, complete the following steps:
 - a. Press the **Alarm** soft key.
 - b. Press the **Alarm at** soft key and select the marker number: M1 to M6 .
 - c. Press the **Limit Line** soft key to set a threshold for the alarm.
 - d. Enter a value by using the numeric keys. You can also use the rotary knob.
 - e. Press the **dBm** soft key.
 - f. Toggle the **Alarm** soft key between **On** and **Off** to turn the alarm feature on or off.
 - g. *Optional.* Press the **Volume** soft key and adjust the volume.
4. To set up the AM/FM audio demodulation, complete the following steps:
 - a. Press the **AM/FM Audio Demod** soft key.
 - b. Toggle the **Audio Demod** soft key between **On** and **Off** to turn the AM/FM audio demodulation on or off.
 - c. Press the **Demod at** soft key, and then select the marker number for the frequency to be demodulated.

NOTE

For the alarm and AM/FM audio demodulation, you must set the marker(s) first by using the **MARKER** hard key as these features use the marker position to sound alarm or demodulate. See “Using marker” on page 49 for more information.

- d. Press the **Demod Mode** soft key, and then select the demodulation mode: **AM**, **FM** and **CW**.
 - e. Press the **Dwell Time** soft key, and then turn the rotary knob to set the demodulation interval between 1 and 20.
 - f. Toggle the **Auto Gain** soft key between **On** and **Off** to enable or disable the automatic gain feature to adjust the interval gain of the demodulator.
 - g. *Optional.* Press the **Volume** soft key and adjust the volume.
5. To start a new measurement, press the **Reset/Restart** soft key.
 6. *Optional.* Go to **SAVE/LOAD > Save**, and then select the save option from the choices available for your measurement mode. See “Using save” on page 31 for more information.
-

Measurement example

Figure 25 Interference measurement in RSSI



NOTE

You can use the **LIMIT** hot key to analyze your measurements with the display line, multi-segment line, and channel limit. See “Setting limit for interference analyzer” on page 103 for more information.

Interference finder

The Interference Finder is an automatic triangulation algorithm that uses GPS coordinates to locate possible interference sources based on three measurements. The interference finder calculates possible interference locations using its inscribed circle or circumscribed circle based on measured intersection points. You can plot up to seven measurement points and select three that are more representative for triangulation. JD780A series automatically logs measurement positions not to lose them while changing measurement modes.

Setting measure setup

Procedure

1. Configure test parameters as described in the “Configuring test parameters” on page 88.
2. To load your map file, complete the following steps:
 - a. Plug in your USB drive that has a map file in .mcf file type created in JDMapCreator.

NOTE

The JDMapCreator converts and resizes a map to fit onto your instrument’s display. You must save your map files (.mcf) into the “**SavedMap**” folder of your USB drive so that you can load them onto your instrument.

- b. Press **SAVE/LOAD** hot key, and then select **Load > Load Map**. See “Using load” on page 34 for more information.
3. Press the **MEASURE SETUP** hot key.
4. Press the **Location Setup** soft key.
5. Press the **Location** soft key.

6. Press the **Point 1** soft key, and then do one of the following option:
 - To automatically get the selected point's positioning information with GPS locked, press the **Get GPS Position**.
The instrument displays the latitude and longitude information of the signal received by a Yagi antenna.
 - To manually determine positioning for the selected point, complete the following steps:
 - a. Press the **Latitude** soft key, and then set the properties: **North/South, Degree, Minute, and Second**.
 - b. Press the **Longitude** soft key, and then set the properties: **East/West, Degree, Minute, and Second**.

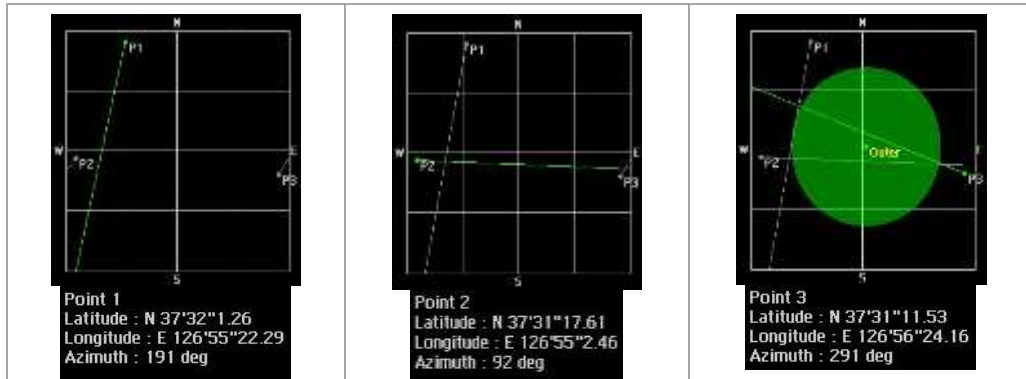

7. Press the **Azimuth** soft key to set an azimuth, and then do one of the following:
 - Without using a compass, turn the rotary knob to align the straight line on the loaded map with the direction of the connected Yagi antenna.
The instrument calculates the azimuth and the angle appears on the screen.
 - Measure an azimuth by using a compass, enter the measured angle, and then press the **Enter** soft key.
8. *Optional.* To save a defined position, press the **Save Position** soft key and then select one of the soft keys to which you want to save the position information. You can use the **Load Position** soft key to load any saved positions.
9. Press the **Point 2** soft key, and then repeat steps 6-7.
10. Press the **Point 3** soft key, and then repeat steps 6-7.
11. Press the **Display Setup** soft key.
12. Press the **Display Mode** soft key, and then select the display mode: **Circum**, **Inscribed**, or **Double**.

NOTE

Change the display to different mode options and check possible location of the interfering signal.

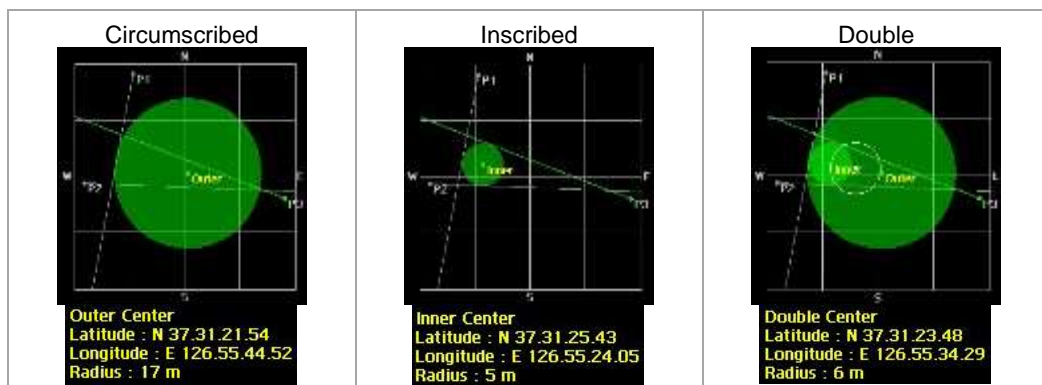

13. Toggle the **Screen Mode** soft key and select the display option: **Map** or **Full**.
 - **Map**: Displays points on the loaded map.
 - **Full**: Displays points without the map.

Measurement example

Figure 26 Interference finder measurement in map view



Spectrum Replayer

The Spectrum Replayer lets you retrieve and replay recorded spectrum analyzer traces in interference analysis mode. These traces can be played back in the spectrogram or RSSI. You can configure the limit line to create failure points when signals exceed it. The failure points are clearly displayed on the trace timeline for quick access during playback.

Setting measure setup

Procedure

1. Press the **MEASURE** hot key.
2. Press the **Spectrum Replayer** soft key. The file manager window appears.
3. Select a file to be loaded, and then press the **Load** soft key. The Measure Setup screen menus appear.
4. Toggle the **Replay Direction** soft key between **FWD** and **REV** to change play direction to forward or reverse.
5. Press the **Replay Speed** soft key, and then select the speed option: **x1**, **x2**, **x3**, and **x4**.
6. Press the **Play** soft key to start playing.
7. Press the **Pause** soft key to pause or stop playing data.
8. To move to a particular failure position directly and play from there, complete the following steps:
 - a. Press the **Jump to Fail Index** soft key.

- b. Enter a value by using the numeric keys.
 - c. Press the **Enter** soft key.
9. *Optional.* Toggle the **Time Cursor** soft key between **On** and **Off** to display or dismiss the time cursor on the screen. This key becomes activated when you play logged data in the Spectrogram mode.

NOTE

If you connected a USB drive, do not remove it while playing. Doing so may freeze the USB port, which will require you to restart the instrument to get a USB drive recognized again.

Setting display

You can select the display option.

Procedure

1. Press the **TRACE/DISPLAY** hard key.
2. Select the display option: **Spectrum**, **Spectrogram**, or **RSSI**.

NOTE

You can use the **LIMIT** hot key to analyze your measurements with the display line, multi-segment line, and channel limit. See "Setting limit for interference analyzer" on page 103 for more information.

Setting limit for interference analyzer**Procedure****To use the display line:**

1. Press the **LIMIT** hot key.
2. Press the **Display Line** soft key for a reference line.
3. Enter a value, and then press the **dBm** unit soft key.
4. Toggle the **Display Line** soft key between **On** and **Off** to display and dismiss the reference line. The straight line appears across the screen to be used as a visual reference only.

To display the multiple segment line:

1. Press the **LIMIT** hot key.
2. Press the **Multi Segment Line** soft key for Pass/Fail indication.
3. Toggle the **Limit** soft key between **Upper** and **Lower** to select the one to be displayed.
4. Set the number of segments for the selected upper or lower limit line. You can set up to 50 segments.
 - a. Press the **# of Line** soft key.
 - b. Enter a value between 1 and 50 by using the numeric keys.
 - c. Press the **Enter** soft key.
5. Press the **Autoset** soft key to let the instrument set the limit for each segment and display the line.
6. *Optional.* To move the limit line, complete the following steps:

- a. Select **Limit Up/Down** or **Limit Left/Right**.
 - b. Turn the rotary knob to move the line as desired. You can also manually enter a value.
7. *Optional.* To edit the segment properties, complete the following steps:
- a. Press the **Edit Limit** soft key.
 - b. Press the **Move** soft key and then turn the rotary knob to select the segment to edit.
 - c. Select the menu option, from the following choices:
 - To hide the line for the selected segment, toggle the **Line** soft key and select **Off**.
 - To add a new point, press the **Add Point** soft key.
 - To delete the selected point, press the **Delete Point** soft key.
 - To change the position, press the **Frequency** or **Amplitude** soft key, and then turn the rotary knob to change the value as desired.

To define the channel limit:

1. Press the **LIMIT** hot key.
 2. Press the **Channel Limit** soft key.
 3. To define the index table, complete the following steps:
 - a. Toggle the **Table** soft key between **On** and **Off** to display and hide the channel index table on the screen.
 - b. Press the **Index** soft key.
 - c. Enter an index number to be set between 1 and 10 by using the numeric keys.
 - d. Press the **Enter** soft key.
 - e. Press the **Start Frequency** or **Center Frequency** soft key depending on your prior frequency setting.
 - f. Enter a value by using the numeric keys. You can also use the rotary knob or the arrow keys.
 - g. Select the unit: **GHz**, **MHz**, **kHz**, or **Hz**.
 - h. Press the **Stop Frequency** or **Span Width** soft key depending on your prior frequency setting.
 - i. Enter a value by using the numeric keys. You can also use the rotary knob or the arrow keys.
 - j. Select the unit: **GHz**, **MHz**, **kHz**, or **Hz**.
 4. To set the limits for Pass/Fail indication, complete the following steps:
 - a. Toggle the **Limit** soft key between **On** and **Off** to enable and disable the limit.
 - b. Press the **High Limit** soft key.
 - c. Enter a value by using the numeric keys. You can also use the rotary knob or the arrow keys.
 - d. Press the **dBm** soft key.
 - e. Press the **Low Limit** soft key.
 - f. Enter a value by using the numeric keys. You can also use the rotary knob or the arrow keys.
 - g. Press the **dBm** soft key.
 5. *Optional.* Go to **SAVE/LOAD > Save**, and then select **Limit** to save the limit settings. See "Using save" on page 31 for more information.
-

Using GSM/GPRS/EDGE Signal Analyzer

This chapter provides instructions for using the GSM/GPRS/EDGE Signal Analyzer function (option 022) with GSM//GPRS/EDGE OTA Analyzer function (option 042). Topics discussed in this chapter are as follows:

■ Introduction	106
■ Display overview	106
■ Connecting a cable	107
■ Selecting measurement mode	109
■ Configuring test parameters	109
■ Conducting spectrum measurements	113
■ Conducting RF measurements	114
■ Conducting power vs. time measurements	120
■ Conducting constellation measurements	123
■ Performing auto measurements	125
■ Conducting GSM OTA measurements	127

Introduction

The Global System for Mobile Communications (GSM) is a digital cellular standard that uses Time Division Multiple Access (TDMA) multiplexing scheme and Gaussian Minimum Shift Keying (GMSK) modulation. The Enhanced Data Rates for GSM Evolution (EDGE) is an enhancement to GSM that promises to deliver multimedia and other broadband applications. It uses TDMA and $3\pi/8$ 8PSK (phase shift keying) modulation.

This instrument performs measurements using the methods and limits as defined in the 3GPP TS 51.021 Base Station System (BSS) equipment specification: Radio Aspects V8.9.0 (2003-06). The Pass/Fail indicator helps you to determine base station performance easily.

This instrument provides the following measurement tools for GSM/GPRS/EDGE system:

- Spectrum Analysis
- RF Analysis
 - Channel Power
 - Occupied Bandwidth
 - Spectrum Emission Mask (SEM)
 - Spurious Emissions
- Power vs. Time
 - Power vs. Time (Slot)
 - Power vs. Time (Frame)
- Modulation Analysis
 - Constellation
- Auto Measure
- Over The Air (OTA)
 - Channel Scanner
 - Frequency Scanner
 - Multipath Profile
 - Modulation Analyzer

Display overview

Figure 27 provides descriptions for each segment of the measurement screen.

Figure 27 GSM signal analyzer measurement screen

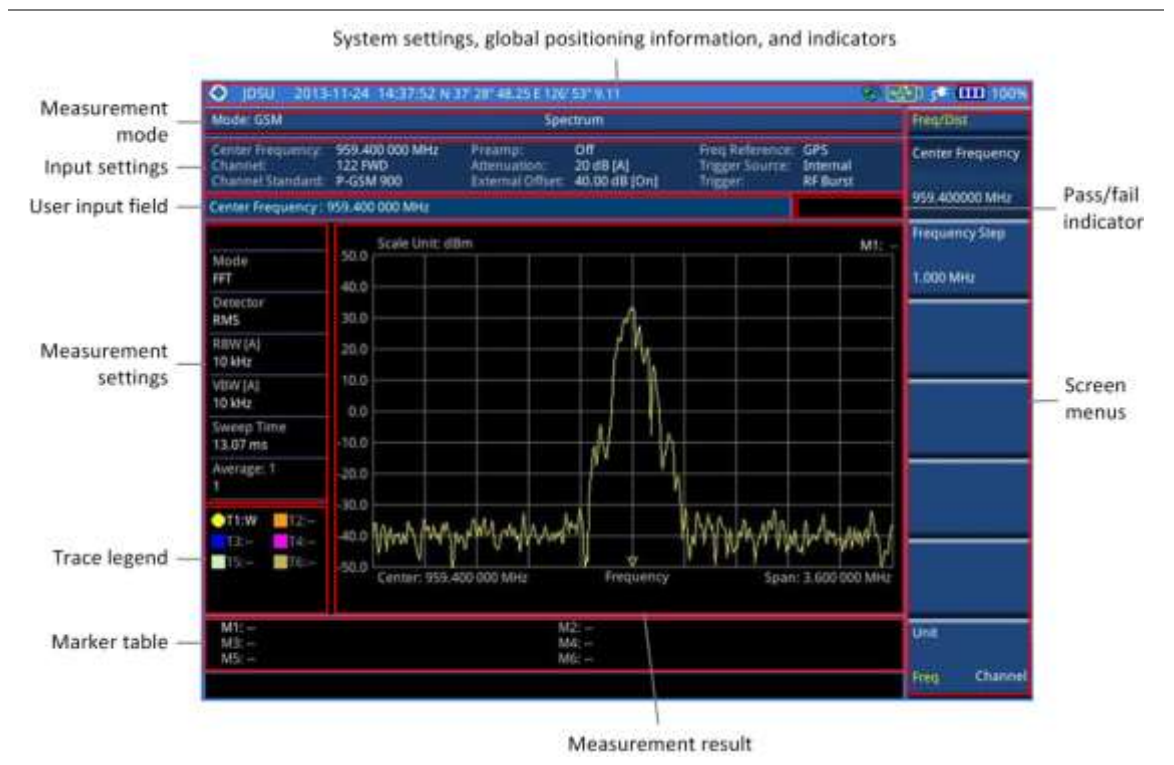

Connecting a cable

Direct connection

Procedure

1. Connect the **Spectrum Analyzer RF In** port of the JD780A series and the power amplifier output port of BTS.

Figure 28 Direct connection



Indirect connection

Procedure

1. Connect the **Spectrum Analyzer RF In** port of the JD780A series and the monitor (test) port of BTS.

Figure 29 Indirect connection

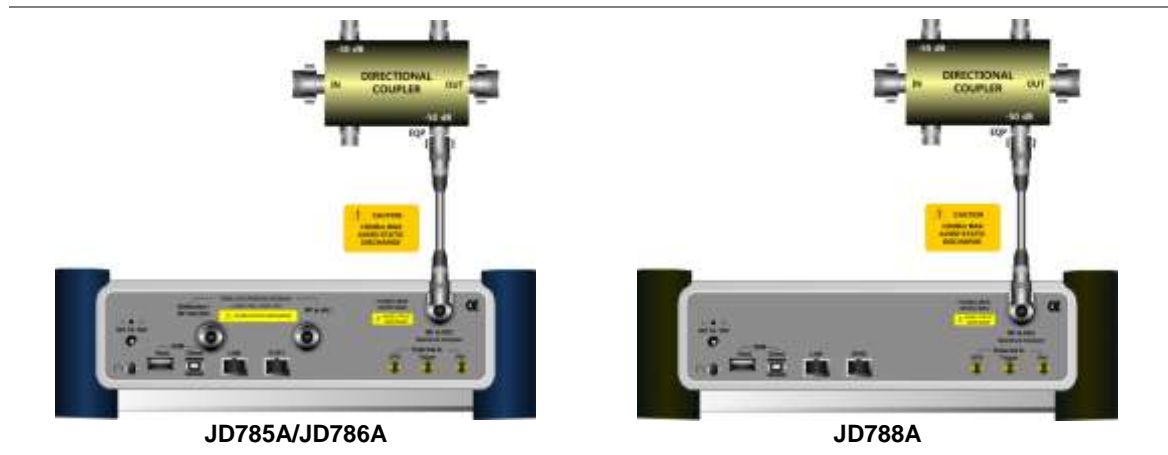

CAUTION
 The maximum power for the **Spectrum Analyzer RF In** port is +25 dBm (0.316 W). If the input signal level to be measured is greater than +25 dBm, use a **High Power Attenuator** to prevent damage when you directly connect the signal to the instrument or connect the signal from the coupling port of a directional coupler.

Over the air (OTA)

Procedure

1. Connect an Omni/directional RF antenna to the **Spectrum Analyzer RF In** port of the JD780A series.
2. Connect a GPS antenna to the **GPS** port of the JD780A series.

Figure 30 OTA connection

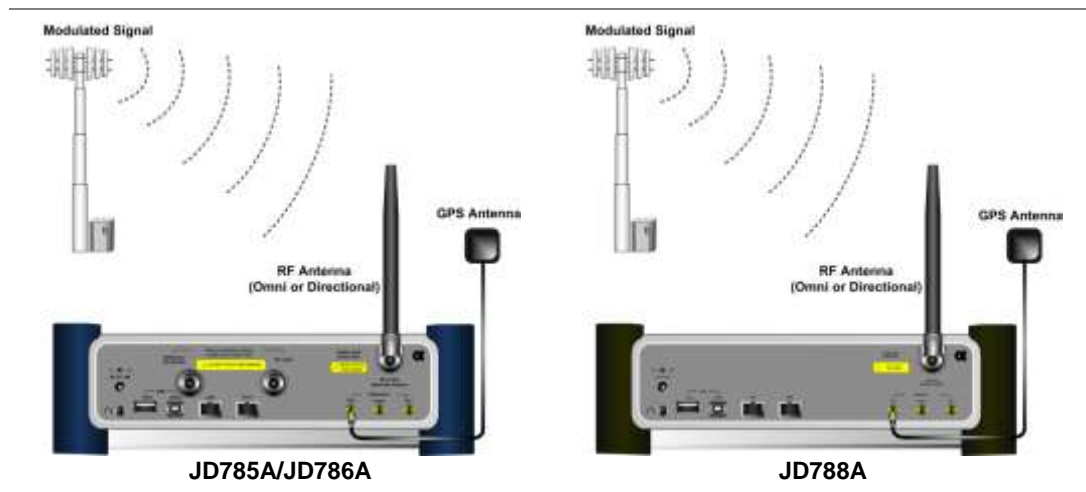

CAUTION
 If the input signal level to be measured is less than 0 dBm, set 0 dB attenuation or turn on the preamp to have better dynamic range for the OTA testing.

Selecting measurement mode

Procedure

1. Press the **MODE** hard key.
 2. Press the **Signal Analyzer** soft key.
 3. Press the **GSM** soft key. The **Spectrum** mode is set by default.
 4. Press the **MEASURE** hot key, and then select the measurement mode option from the following choices:
 - Spectrum
 - RF Analysis > Channel Power, Occupied BW, Spectrum Emission Mask, or Spurious Emissions
 - Power vs Time > Power vs Time (Slot) or Power vs Time (Frame)
 - Constellation
 - Auto Measure
 - OTA > Channel Scanner, Frequency Scanner, Multipath Profile, or Modulation Analyzer
-

Configuring test parameters

Setting frequency

You can set the frequency with either frequency or channel number. If a frequency to be set matches to the frequency corresponding to the selected channel standard, the instrument calculates its channel number and updates the screen with it automatically.

Procedure

To set the center frequency:

1. Press the **FREQ/DIST** hard key.
2. Toggle the **Unit** soft key and select **Freq**.
3. Press the **Center Frequency** soft key.
4. Enter a value by using the numeric keys. You can also use the rotary knob.
5. Select the unit: **GHz**, **MHz**, **kHz**, or **Hz**.
6. *Optional.* To define the amount of frequency increment for the rotary knob, complete the following steps:
 - a. Press the **Frequency Step** soft key.
 - b. Enter a value by using the numeric keys. You can also use the rotary knob.
 - c. Press the unit: **GHz**, **MHz**, **kHz**, or **Hz**.

To set the channel number:

1. Press the **FREQ/DIST** hard key.
 2. Toggle the **Unit** soft key and select **Channel**.
 3. To select the standard channel, complete the following steps:
 - a. Press the **Channel Std** soft key. The standard channel window appears.
See "Appendix C – Band, frequency & channel standard" on page 541 for more information.
-

- b. Select the band to be measured by using the rotary knob, the arrow keys, or the **Page Up/Page Down** soft keys.
 - c. Press the **Select** soft key or the rotary knob to confirm the selection.
4. Press the **Channel Number** soft key.
5. Enter a value by using the numeric keys. You can also use the rotary knob.
6. Press the **Enter** soft key.

The instrument automatically displays the corresponding center frequency value for the selected channel number.

7. *Optional.* To define the amount of channel increment for the rotary knob, complete the following steps:
 - a. Press the **Channel Step** soft key.
 - b. Enter a value by using the numeric keys. You can also use the rotary knob.
 - c. Press the **Enter** soft key.

NOTE

This frequency setting is not used in the Spurious Emissions mode.

Setting amplitude

Reference level and attenuation

You can set the reference and attenuation levels automatically or manually to optimize the display of the traces measured, as you desire.

Procedure

To automatically set the reference and attenuation level:

1. Press the **AMP/SCALE** hard key.
2. Press the **Auto Scale** soft key.
Each time you press this key, both of the Y-axis scale and input attenuation level change to be optimized with some margin.

To set the reference or attenuation level manually:

1. Press the **AMP/SCALE** hard key.
2. To set the maximum reference value on the Y-axis manually, complete the following steps:
 - a. Press the **Reference Level** soft key.
 - b. Enter a value by using the numeric keys or the rotary knob with 10 dB increments.
 - c. Press the **dBm** soft key or the **ENTER** hard key.
3. To set the attenuation option, select one from the following choices:
 - To set the input attenuator's level automatically, select **Attenuation > Auto**.

NOTE

It is recommended that you set the **Attenuation to Auto** in most situations so that the level of the input attenuator can be set automatically according to your input signal level.

- To set the input attenuation manually up to 55 dB to optimize S/N, complete the following steps:
 - a. Select **Attenuation > Manual**.
 - b. Press the **Attenuation Value** soft key to set the level.
-

- c. Enter a value between 0 and 55 in fives by using the numeric keys.
 - d. Press the **dB** soft key or the **ENTER** hard key.
- To couple the input attenuator's level with your reference level setting, select **Attenuation > Couple**.
As you increase the reference setting, the attenuation level also increases accordingly.

Optional. To change the scale unit:

1. Select **More (1/2) > Units**.
2. Select the unit of the display scale: **dBm**, **dBV**, **dBmV**, **dBμV**, **V**, or **W**.
The scale unit on the screen changes accordingly.

NOTE

This Units menu is available in the Spectrum and RF Analysis modes.

Scale per division

You can use the **Scale/Div** feature available for the spectrum and RF analysis. It represents the value of one division on the horizontal scale. The default setting is 10 dB per division and the maximum value can be set up to 20 dB.

Procedure

To set the scale per division:

1. Press the **AMP/SCALE** hard key.
2. Select **More (1/2) > Scale/Div**.
3. Enter a value between 1 and 20 by using the numeric keys.
4. Press the **dB** soft key to complete the entry.

Pre-amplifier

You can turn the internal pre-amplifier on to correct and compensate for the gain of the preamp so that amplitude readings show the value at the input connector.

Procedure

1. Press the **AMP/SCALE** hard key.
2. Toggle the **Preamp** soft key and select **On** or **Off** as needed.

NOTE

You can turn the Preamp on when the input attenuation range is from 0 dB to 10 dB. If the attenuation value is manually set to greater than 10 dB, the instrument will automatically turn off the pre-amplifier to display low-level signal properly on the chart.

External offset

You can turn the **External Offset** on and manually set the external offset value. An offset consists of a cable loss and a user offset and the measurement result shows the value reflecting both offset values. When the external offset value is set at 40 dB in the Spectrum mode, the measurement result compensates 40 dB at both the Spectrum Analyzer and Signal Analyzer modes

Procedure

To set the external offset:

1. Press the **AMP/SCALE** hard key.
2. Toggle the **External Offset** soft key and select **On**.
3. Enter a value by using the numeric keys.
4. Press the **dB** soft key to complete the entry.

To turn the external offset off:

1. Press the **AMP/SCALE** hard key.
 2. Toggle the **External Offset** soft key and select **Off**.
-

Setting average

You can set the number of measurements to be averaged for the trace presentation. A maximum of 100 times of averaging can be set. When the averaging reaches to your setting, a new measurement value replaces the measurement value in sequence from the earliest.

Procedure

1. Press the **BW/AVG** hard key.
 2. Press the **Average** soft key.
 3. Enter a value between 1 and 100 as needed by using the numeric keys.
 4. Press the **Enter** soft key.
-

Setting sweep mode

The default settings of the sweep mode are **Continue** and **Normal** to sweep continuously at a normal speed for most on-going measurements. If you want to hold the measurement or get a single sweep, you can change the sweep mode.

Procedure

To select the single sweep mode:

1. Press the **SWEEP** hot key.
2. Toggle the **Sweep Mode** soft key and select **Single**. You can also use the **HOLD** hot key. The letter **HOLD** in red appears and the sweeping is paused.
3. *Optional.* Press the **Sweep Once** soft key to get a new measurement.

To return to the continuous sweep mode:

1. Toggle the **Sweep Mode** soft key and select **Continue**. You can also use the **HOLD** hot key. The letter **HOLD** in red disappears and the sweeping resumes.
-

Setting trigger source

You can set the trigger source option for your measurements.

Procedure

1. Press the **TRIGGER** hot key.
2. Select the trigger source option from the following choices:

To set the trigger level	Select
When using the RF burst (wideband) trigger	RF Burst
To free burst if there is a frequency burst signal	Internal FB
To training sequence code	RF Burst & TS
To external trigger reference	External
To the free trigger	Free

Conducting spectrum measurements

If you have configured test parameters as described in the “Configuring test parameters” on page 109, your measurement result is displayed on the screen as like the following example, Figure 31.

Figure 31 Spectrum measurement screen with GSM signal analyzer



Setting measure setup

Procedure

Optional.

1. Press the **MEASURE SETUP** hot key.
2. Press the **Miscellaneous** soft key.
3. Press the **Delay** soft key to set the amount of delay in μ s.
4. Enter a value by using the numeric keys. You can also use the rotary knob.
5. Press the μ s soft key.

NOTE

The Delay setting is used only when there is a time offset in the signals to be measured.

Setting trace

You can display up to six traces on the measurement chart simultaneously.

Procedure

1. Press the **TRACE/DISPLAY** hard key.
2. Press the **Select Trace** soft key, and then select the trace number: **T1**, **T2**, **T3**, **T4**, **T5**, or **T6**. The legend shape of the selected trace changes from square to round to indicate that the trace is the active one now.
3. Toggle the **Trace View** soft key and select **On**.
4. To clear, write or capture, or hide the trace(s), do one of the following:

To	Select	Trace Legend
Clear current data and display with new measurements	Clear Write	W
Display the input signal's maximum response only	Max Hold	M
Display the input signal's minimum response only	Min Hold	m
Capture the selected trace and compare traces	Capture	C
Load a saved trace	More (1/2) > Load	L
Hide the selected trace	Trace View > Off	F
Remove all the traces and initialize the trace settings	More (1/2) > Trace Clear All	

5. *Optional.* Press the **More (1/2) > Trace Info** soft key, and then select the trace number to view the trace's parameter setting information stored at the time of the measurement or **None** to hide the information display.
 6. *Optional.* If you have the two traces T1 and T2, you can perform trace math. To view the power difference between the traces, press the **T1 – T2 -> T5** or **T2 – T1 -> T6** soft key. The result is overlaid on the screen along with the second Y-axis.
-

Conducting RF measurements

Channel power

The Channel Power measures in-channel power for GSM/GPRS and EDGE systems, which use dynamic power control to ensure that each link is maintained with minimum power. It gives two fundamental benefits of keeping overall system interference to a minimum level and of maximizing battery life in the case of mobile stations. It determines the power delivered to the antenna system on the RF channel under test. The instrument acquires a GSM/GPRS or EDGE signal in the time domain. The average power level above the threshold is then computed and displayed.

Setting measure setup

After configuring test parameters as described in the “Configuring test parameters” on page 109, you

can continue your measurement.

Procedure

Optional. To set the delay, complete the following steps:

1. Press the **MEASURE SETUP** hot key.
 2. Press the **Miscellaneous** soft key.
 3. Press the **Delay** soft key to set the amount of delay in μs .
 4. Enter a value by using the numeric keys. You can also use the rotary knob.
 5. Press the **μs** soft key.
-

NOTE

The Delay setting is used only when there is a time offset in the signals to be measured.

Measurement example

Figure 32 Channel power measurement with GSM signal analyzer



Channel power measurement result shows channel power and spectrum density in a user specified channel bandwidth. The peak to average ratio (PAR) is shown at the bottom of the screen as well. The shaded area on the display indicates the channel bandwidth.

NOTE

You can use the **LIMIT** hot key to analyze your measurements with the user-definable limit and Pass/Fail indication. See “Setting limit for RF tests” on page 119 for more information.

Occupied bandwidth

The Occupied Bandwidth measures the spectrum shape of the carrier. It is defined as the bandwidth, which includes 99% of the transmitted power among total transmitted power.

Setting measure setup

After configuring test parameters as described in the “Configuring test parameters” on page 109, you can continue your measurement.

Procedure

Optional. To set the delay, complete the following steps:

1. Press the **MEASURE SETUP** hot key.
2. Press the **Miscellaneous** soft key.
3. Press the **Delay** soft key to set the amount of delay in μ s.
4. Enter a value by using the numeric keys. You can also use the rotary knob.
5. Press the **μ s** soft key.

NOTE

The Delay setting is used only when there is a time offset in the signals to be measured.

Measurement example

The Occupied Bandwidth measurement shows both of power across the band and power bandwidth in a user specified percentage to determine the amount of spectrum used by a modulated signal. Occupied bandwidth is typically calculated as the bandwidth containing 99% of the transmitted power.

Figure 33 Occupied bandwidth measurement with GSM signal analyzer



NOTE

You can use the **LIMIT** hot key to analyze your measurements with the user-definable limit and Pass/Fail indication. See “Setting limit for RF tests” on page 119 for more information.

Spectrum emission mask (SEM)

The Spectrum Emission Mask (SEM) measurement is to identify and determine the power level of out-of-band spurious emission outside the necessary channel bandwidth and modulated signal. It measures the power ratio between in-band and adjacent channels. The JD780A series indicates either

Pass or Fail based on the specified limit of the signal.

Setting measure setup

After configuring test parameters as described in the “Configuring test parameters” on page 109, you can continue your measurement.

Procedure

Optional. To set the delay, complete the following steps:

1. Press the **MEASURE SETUP** hot key.
2. Press the **Miscellaneous** soft key.
3. Press the **Delay** soft key to set the amount of delay in μ s.
4. Enter a value by using the numeric keys. You can also use the rotary knob.
5. Press the **μ s** soft key.

NOTE

The Delay setting is used only when there is a time offset in the signals to be measured.

Measurement example

Figure 34 SEM measurement with GSM signal analyzer



NOTE

You can use the **LIMIT** hot key to analyze your measurements with the user-definable limit and Pass/Fail indication. See “Setting limit for RF tests” on page 119 for more information.

Spurious emissions

Out-of-band emissions are unwanted emissions immediately outside the channel bandwidth resulting from the modulation process and non-linearity in the transmitter but excluding spurious emissions. The Spurious Emissions measurement is to identify and determine the power level of out-of-band spurious emission within the necessary channel bandwidth and modulated signal measured at the RF port of

the Base Station.

Setting measure setup

After configuring test parameters as described in the “Configuring test parameters” on page 109, you can continue your measurement.

Procedure

1. Press the **MEASURE SETUP** hot key.
2. To set up the range table and frequency range, press the **Range Table** soft key and then complete the following steps:
 - a. Press the **Range** soft key, and then enter the range number to add a new range or change an existing one.
 - b. Press the **Enter** soft key.
 - c. Press the **Start Frequency** soft key to set up the frequency range.
 - d. Enter a value by using the numeric keys. You can also use the rotary knob.
 - e. Select the unit: **GHz**, **MHz**, **kHz**, or **Hz**.
 - f. Press the **Stop Frequency** soft key to set up the frequency range.
 - g. Enter a value by using the numeric keys. You can also use the rotary knob.
 - h. Select the unit: **GHz**, **MHz**, **kHz**, or **Hz**.
3. Toggle the **Range** soft key between **On** and **Off** to display or hide the selected range.
4. To set up the test limits for Pass/Fail indication, complete the following steps:
 - a. Press the **Start Limit** soft key.
 - b. Enter a value by using the numeric keys. You can also use the rotary knob.
 - c. Select the **dBm** soft key.
 - d. Press the **Stop Limit** soft key.
 - e. Enter a value by using the numeric keys. You can also use the rotary knob.
 - f. Select the **dBm** soft key.
5. To set up the other parameters, complete the following steps:
 - a. Select **More (1/2) > Attenuation** to set up the attenuation value.
 - b. Enter a value in the multiple of five.
 - c. Press the **dB** soft key or the **ENTER** hard key.
 - d. Press the **RBW** soft key.
 - e. Enter a value by using the numeric keys.
 - f. Select the unit: **GHz**, **MHz**, **kHz**, or **Hz**.
 - g. Press the **VBW** soft key.
 - h. Enter a value by using the numeric keys.
 - i. Select the unit: **GHz**, **MHz**, **kHz**, or **Hz**.
6. Press the **PREV** hard key.
7. Toggle the **Measure Type** soft key between **Examine** and **Full** to select the measurement type.

NOTE

The **Examine** mode displays only the selected range while the **Full** mode lets the instrument automatically changes the selected range from one another.

8. Set the number of measurements to be averaged:
 - a. Press the **Average** soft key.
 - b. Enter a value between 1 and 100.
 - c. Press the **Enter** soft key.

Measurement example

Figure 35 Spurious emissions measurement with GSM signal analyzer



NOTE

You can use the **LIMIT** hot key to analyze your measurements with the user-definable limit and Pass/Fail indication. See “Setting limit for RF tests” on page 119 for more information.

Setting limit for RF tests

By default, test limits specified in the standard are set for you. You can change thresholds if you desire.

Procedure

1. Press the **LIMIT** hot key.
2. Press the **RF Test Limits** soft key.
3. Select the test item(s) and set the limit(s) depending on your selected measurement mode:

To set the limit for	Select	Set
Channel power	Channel Power	High Limit, Low Limit
Occupied bandwidth	Occupied BW	High Limit
Spectrum emission mask	Spectrum Emission Mask	(On/Off only)
ACLR	ACLR	(On/Off only)
Multi-ACLR	Multi-ACLR	(On/Off only)

Spurious emissions	Spurious Emissions	(On/Off only)
--------------------	--------------------	---------------

4. *Optional.* You can enable alarm sound that goes off if the measurement falls outside of the limit. Toggle the **Beep** soft key between **On** and **Off** to enable or disable the beep sound.
5. *Optional.* Go to **SAVE/LOAD > Save**, and then select **Limit** to save the limit settings. See “Using save” on page 31 for more information.

Conducting power vs. time measurements

The Power vs. Time measurement measures the mean transmission power during the useful part of GSM bursts and verifies that the power ramp fits within the defined mask. It also lets you view the rise, fall, and useful part of the GSM burst.

This measurement provides masks for both of Base Transceiver Station (BTS) and Mobile Station (MS). The timing masks are referenced to the transition from the bit 13 to the bit 14 of the mid-amble training sequence. For GMSK measurements, the 0 dB reference is determined by measuring the mean transmitted power during the useful part of the burst.

Power vs. time (slot)

Setting measure setup

After configuring test parameters as described in the “Configuring test parameters” on page 109, you can continue your measurement. The measurement settings can be saved and recalled as a file.

Procedure

1. Press the **MEASURE SETUP** hot key.
2. Press the **Detect Mode** soft key, and then select the signal standard option: **Auto**, **GSM**, or **EDGE**. Auto is set by default. The instrument applies a mask automatically based on the selected mode.
3. *Optional.* To set the delay, complete the following steps:
 - a. Press the **Miscellaneous** soft key.
 - b. Press the **Delay** soft key to set the amount of delay in μ s.
 - c. Enter a value by using the numeric keys. You can also use the rotary knob.
 - d. Press the **μ s** soft key.

NOTE

The Delay setting is used only when there is a time offset in the signals to be measured.

Setting limit for burst power

Procedure

1. Press the **LIMIT** hot key.
 2. Press the **PvsT Test Limits** soft key.
 3. Press the **Burst Power** soft key to set the limit in the Power vs. Time (Slot) measurement.
 4. Toggle the **Test Limits** soft key between **On** and **Off** to enable or disable the Pass/Fail indication.
-

5. Set the upper threshold:
 - a. Press the **High Limit** soft key.
 - b. Enter a value for the upper limit, and then press the **dBm** unit soft key.
6. Set the lower threshold:
 - a. Press the **Low Limit** soft key.
 - b. Enter a value for the lower limit, and then press the **dBm** unit soft key.
7. *Optional.* You can enable alarm sound that goes off if the measurement falls outside of the limit. Toggle the **Beep** soft key between **On** and **Off** to enable or disable the beep sound.
8. *Optional.* Go to **SAVE/LOAD > Save**, and then select **Limit** to save the limit settings. See "Using save" on page 31 for more information.

Measurement example

Figure 36 Power vs. time (slot) measurement with GSM/EDGE signal analyzer



Power vs. time (frame)

Setting measure setup

After configuring test parameters as described in the “Configuring test parameters” on page 109, you can continue your measurement. The measurement settings can be saved and recalled as a file.

Procedure

1. Press the **MEASURE SETUP** hot key.
 2. Press the **Detect Mode** soft key, and then select the signal standard option: **Auto**, **GSM**, or **EDGE**. Auto is set by default. The instrument applies a mask automatically based on the selected mode.
 3. *Optional.* To set the delay, complete the following steps:
 - a. Press the **Miscellaneous** soft key.
 - b. Press the **Delay** soft key to set the amount of delay in μs .
 - c. Enter a value by using the numeric keys. You can also use the rotary knob.
 - d. Press the **μs** soft key.
-

NOTE

The Delay setting is used only when there is a time offset in the signals to be measured.

Setting limit for frame average power

Procedure

1. Press the **LIMIT** hot key.
 2. Press the **PvsT Test Limits** soft key.
 3. Press the **Frame Avg Power** soft key to set the limit in the Power vs. Time (Frame) measurement.
 4. Toggle the **Test Limits** soft key between **On** and **Off** to enable or disable the Pass/Fail indication.
 5. Set the upper threshold:
 - a. Press the **High Limit** soft key.
 - b. Enter a value for the upper limit.
 - c. Press the **dBm** unit soft key.
 6. Set the lower threshold:
 - a. Press the **Low Limit** soft key.
 - b. Enter a value for the lower limit.
 - c. Press the **dBm** unit soft key.
 7. *Optional.* You can enable alarm sound that goes off if the measurement falls outside of the limit. Toggle the **Beep** soft key between **On** and **Off** to enable or disable the beep sound.
 8. *Optional.* Go to **SAVE/LOAD > Save**, and then select **Limit** to save the limit settings. See “Using save” on page 31 for more information.
-

Measurement example

Figure 37 Power vs. time (frame) measurement with GSM signal analyzer



Conducting constellation measurements

The Constellation is used to observe some aspects of modulation accuracy and can reveal certain fault mechanisms such as I/Q amplitude imbalance or quadrature imbalance. It displays constellation diagram by modulation types.

Setting measure setup

After configuring test parameters as described in the “Configuring test parameters” on page 109, you can continue your measurement. The measurement settings can be saved and recalled as a file.

Procedure

1. Press the **MEASURE SETUP** hot key.
2. Press the **Detect Mode** soft key, and then select the signal standard option: **Auto**, **GSM**, or **EDGE**. Auto is set by default. The instrument applies a mask automatically based on the selected mode.
3. Toggle the **PSK Constellation** soft key between **On** and **Off** to enable or disable the PSK constellation observation.

NOTE

The PSK constellation must be turned on to analyze EDGE signals.

4. *Optional.* To set the delay, complete the following steps:
 - a. Press the **Miscellaneous** soft key.
 - b. Press the **Delay** soft key to set the amount of delay in μ s.
 - c. Enter a value by using the numeric keys. You can also use the rotary knob.
 - d. Press the **μ s** soft key.

NOTE

The Delay setting is used only when there is a time offset in the signals to be measured.

Setting limit for constellation

Procedure

1. Press the **LIMIT** hot key.
2. Press the **Modulation Test Limits** soft key to set the limits in the Constellation measurement.
3. Select the test item(s) and set the limit(s) depending on your selected measurement mode:

To set the limit for	Select	Set
Frequency error	Frequency Error	High Limit, Low Limit
Phase error rms	Phase Error RMS	High Limit, Low Limit
Phase error peak	Phase Error Peak	High Limit, Low Limit
Error vector magnitude rms	EVM RMS	High Limit
Error vector magnitude peak	EVM Peak	High Limit
I/Q origin offset of the I and Q error (magnitude squared) offset from the origin	IQ Origin Offset	High Limit
Carrier to interference (C/I) ratio	C/I	Low Limit

4. *Optional.* You can enable alarm sound that goes off if the measurement falls outside of the limit. Toggle the **Beep** soft key between **On** and **Off** to enable or disable the beep sound.
5. *Optional.* Go to **SAVE/LOAD > Save**, and then select **Limit** to save the limit settings. See “Using save” on page 31 for more information.

Measurement example

Figure 38 Constellation measurement with GSM signal analyzer



**NOTE**

Measurement items such as IQ Origin Offset, C/I, EVM RMS/Peak and EVM 95th are applicable only to EDGE signal measurements.

Performing auto measurements

The Auto Measure function of the JD780A series allows a complete signal profiling covering RF characterization and modulation quality parameters of up to 10 different carriers, particularly useful on an overlay architecture where base stations are transmitting in different frequencies.

The Auto Measure can be easily executed either by selecting a menu in the instrument or by running a programmed scenario in the PC-based application so that the instrument automatically configure and perform tests on every aspect of all the carriers.

Setting limit for auto measure

You can set test limits for test item(s) in the auto measurement.

Procedure

1. Press the **LIMIT** hot key.
2. Press the **RF Test Limits** soft key, and then enable test limits as desired.
3. Press the **PvsT Test Limits** soft key, and then enable test limits as desired.
4. Press the **Modulation Test Limits** soft key, and then enable test limits as desired.
5. *Optional.* You can enable alarm sound that goes off if the measurement falls outside of the limit. Toggle the **Beep** soft key between **On** and **Off** to enable or disable the beep sound.
6. *Optional.* Go to **SAVE/LOAD > Save**, and then select **Limit** to save the limit settings. See "Using save" on page 31 for more information.

Setting measure setup

After configuring test parameters as described in the "Configuring test parameters" on page 109, you

can continue your measurement. The measurement settings can be saved and recalled as a file. You can also use JDViewer, PC application software to configure a measure setup, save as a file, and load the file on to the instrument.

Procedure

1. Press the **MEASURE SETUP** hot key.
 2. Toggle the **Configuration** soft key and select the configuration option:
 - **Current**: to let the instrument use current frequency (single carrier) and determine pass or fail based on the instrument's limit settings in Auto Measure.
 - **Scenario**: to run a test with a programmed scenario in JDViewer. The Scenario menu becomes activated.
 3. To load a scenario, press the **Scenario** soft key, and then select a scenario file to load.
 4. Toggle the **Test Time** soft key and select the test time option:
 - **Now**: to let the instrument run a test only once.
 - **Schedule**: to let the instrument repeat tests as defined in the Set Timing. The Set Timing menu becomes activated.
 5. To define a schedule for an auto measurement, complete the following steps:
 - a. Press the **Set Timing** soft key.
 - b. Press the **Start Time (HH:MM)** soft key.
 - c. Enter the time in the HH:MM format, and then press the **Enter** soft key.
 - d. Press the **Stop Time (HH:MM)** soft key.
 - e. Enter the time in the HH:MM format, and then press the **Enter** soft key.
 - f. Press the **Time Interval** soft key.
 - g. Enter the amount of time in minutes, and then press the **Enter** soft key.
 6. To set external offset, complete the following steps:
 - a. Toggle the **External Offset** soft key and select **On**.
 - b. Enter a value by using the numeric keys, and then press the **dB** soft key.
 7. To save your settings and results, go to **SAVE/LOAD > Save** and then perform functions as you desire. See "Using save" on page 31 for more information.
 8. Press the **Run Test** soft key to start to run a test. The Auto Measure Results window appears at the end of the test.
 9. To stop running the test, press the **Abort** soft key.
 10. To change the view on the screen during the test, press the **Display** and then select the view option from the following choices:
 - **Screen**: You can view each measurement screen as the test progresses.
 - **Results**: You can view a measurement result table as the test progresses.
 - **Settings**: You can view a measurement setting table as the test progresses.
-

Setting display

After completion of the auto measurement, the screen menu changes to Trace/Display so that you can view the results in different forms.

Procedure

1. Toggle the **Display** soft key and select the display option:
 - **Result**: to view the result table. The Display Result menu becomes activated.
 - **Settings**: to view the measurement settings for the auto measurement.
 2. Toggle the **Display Result** soft key and select the display result option:
 - **Full**: to view detailed measurement readings with the pass/fail indication.
 - **Quick**: to view only the Pass/Fail results.
 3. To view the measurement results for a different carrier, press the **View Carrier** soft key and then select the carrier number to view.
-

Conducting GSM OTA measurements

This Over-The-Air (OTA) measurement has channel scanner, frequency scanner, multipath profile, and modulation analyzer screens. The GSM OTA has a function to display channel power and related information up to 128 GSM down link signals. This channel scanner can quickly identifies improper power levels that affect network performance. The transmitter performance can be made on a base station from the convenience of your vehicle without taking the base station out of service. It helps you to determine testing area's RF environmental condition with the multipath profile.

Channel scanner

Setting channel

Procedure

1. Press the **FREQ/DIST** hard key.
 2. To select the standard channel, complete the following steps:
 - a. Press the **Channel Std** soft key. The standard channel window appears. See "Appendix C – Band, frequency & channel standard" on page 541 for more information.
 - b. Select the band to be measured by using the rotary knob, the arrow keys, or the **Page Up/Page Down** soft keys.
 - c. Press the **Select** soft key or the rotary knob to confirm the selection.
 3. To set the starting channel to be scanned, complete the following steps:
 - a. Press the **Channel Number** soft key.
 - b. Enter a value by using the numeric keys. You can also use the rotary knob.
 - c. Press the **Enter** soft key.
 4. To set the amount of channel increment in scanning channels, complete the following steps:
 - a. Press the **Channel Step** soft key.
 - b. Enter a value by using the numeric keys. You can also use the rotary knob.
 - c. Press the **Enter** soft key.
 5. To set the number of channels to be displayed, complete the following steps:
 - a. Press the **# of Channels** soft key.
 - b. Enter a value by using the numeric keys. You can also use the rotary knob.
 - c. Press the **Enter** soft key.
-

Setting zoom position

You can set the starting channel for the Zoom In Window.

Procedure

1. Press the **TRACE/DISPLAY** hard key.
 2. Press the **Zoom Position** soft key.
 3. Enter a value by using the numeric keys. You can also use the rotary knob.
 4. Press the **Enter** soft key.
-

Setting limit for OTA channel scanner

Procedure

1. Press the **LIMIT** hot key.
 1. Press the **Limit Line** soft key to set a threshold for the limit line and Pass/Fail indication.
 2. Enter a value, and then press the **dBm** unit soft key.
 3. Toggle the **Limit Line** soft key between **On** and **Off** to display or dismiss the limit line.
 4. *Optional.* You can enable alarm sound that goes off if the measurement falls outside of the limit. Toggle the **Beep** soft key between **On** and **Off** to enable or disable the beep sound.
 5. *Optional.* Go to **SAVE/LOAD > Save**, and then select the save option from the choices available for your measurement mode. See “Using save” on page 31 for more information.
-

Measurement example

Figure 39 Channel scanner measurement with GSM OTA signal analyzer



Frequency scanner

Setting frequency

Procedure

1. Press the **FREQ/DIST** hard key.
 2. To set the starting frequency to be scanned, complete the following steps:
 - a. Press the **Start Frequency** soft key.
 - b. Enter a value by using the numeric keys. You can also use the rotary knob.
 - c. Select the unit: **GHz**, **MHz**, **kHz**, or **Hz**.
 3. To set the amount of frequency increment in scanning frequencies, complete the following steps:
 - a. Press the **Frequency Step** soft key.
 - b. Enter a value by using the numeric keys. You can also use the rotary knob.
 - c. Select the unit: **GHz**, **MHz**, **kHz**, or **Hz**.
 4. To set the number of frequencies to be displayed, complete the following steps:
 - a. Press the **# of Frequencies** soft key.
 - b. Enter a value by using the numeric keys. You can also use the rotary knob.
 - c. Press the **Enter** soft key.
-

Setting zoom position

You can set the starting channel for the Zoom Window.

Procedure

1. Press the **TRACE/DISPLAY** hard key.
 2. Press the **Zoom Position** soft key.
 3. Enter a value by using the numeric keys. You can also use the rotary knob.
 4. Press the **Enter** soft key.
-

Setting limit for OTA frequency scanner

Procedure

1. Press the **LIMIT** hot key.
 2. Press the **Limit Line** soft key to set a threshold for the limit line and Pass/Fail indication.
 3. Enter a value, and then press the **dBm** unit soft key.
 4. Toggle the **Limit Line** soft key between **On** and **Off** to display or dismiss the limit line.
 5. *Optional.* You can enable alarm sound that goes off if the measurement falls outside of the limit. Toggle the **Beep** soft key between **On** and **Off** to enable or disable the beep sound.
 6. *Optional.* Go to **SAVE/LOAD > Save**, and then select **Limit** to save the limit settings. See "Using save" on page 31 for more information.
-

Measurement example

Figure 40 Frequency scanner measurement with GSM OTA signal analyzer



Multipath profile

The Multipath Profile let you determine RF environmental conditions of testing area. The multipath profile is the result of portions of the original broadcast signal arriving at the receiving antenna out of phase. This can be caused by the signal being reflected off objects such as buildings, or being refracted through the atmosphere differently from the main signal.

Setting measure setup

After configuring test parameters as described in the “Configuring test parameters” on page 109, you can continue your measurement. The measurement settings can be saved and recalled as a file.

Procedure

1. Press the **MEASURE SETUP** hot key.
2. Press the **Detect Mode** soft key, and then select the signal standard option: **Auto**, **GSM**, or **EDGE**. Auto is set by default. The instrument applies a mask automatically based on the selected mode.
3. *Optional.* To set the delay, complete the following steps:
 - a. Press the **Miscellaneous** soft key.
 - b. Press the **Delay** soft key to set the amount of delay in μ s.
 - c. Enter a value by using the numeric keys. You can also use the rotary knob.
 - d. Press the **μ s** soft key.
4. *Optional.* Go to **SAVE/LOAD > Save**, and then select the save option from the choices available for your measurement mode. See “Using save” on page 31 for more information.

NOTE

The Delay setting is used only when there is a time offset in the signals to be measured.

Measurement example

Figure 41 Multipath profile measurement with GSM OTA signal analyzer



Modulation analyzer

Setting measure setup

After configuring test parameters as described in the “Configuring test parameters” on page 109, you can continue your measurement. The measurement settings can be saved and recalled as a file.

Procedure

1. Press the **MEASURE SETUP** hot key.
2. Press the **Detect Mode** soft key, and then select the signal standard option: **Auto**, **GSM**, or **EDGE**. Auto is set by default. The instrument applies a mask automatically based on the selected mode.
3. *Optional.* To set the delay, complete the following steps:
 - a. Press the **Miscellaneous** soft key.
 - b. Press the **Delay** soft key to set the amount of delay in µs.
 - c. Enter a value by using the numeric keys. You can also use the rotary knob.
 - d. Press the **µs** soft key.
4. *Optional.* Go to **SAVE/LOAD > Save**, and then select the save option from the choices available for your measurement mode. See “Using save” on page 31 for more information.

NOTE

The Delay setting is used only when there is a time offset in the signals to be measured.

Setting limit for modulation analyzer

Procedure

1. Press the **LIMIT** hot key.
2. Select the test item(s) and set the limit(s):

To set the limit for	Select	Set
Frame average power	Frame Average Power	High Limit Low Limit
Frequency error	Frequency Error	High Limit Low Limit
Burst power	Burst Power	High Limit Low Limit
ACLR	ACLR	(On/Off only)
Multi-ACLR	Multi-ACLR	(On/Off only)
Spurious emissions	Spurious Emissions	(On/Off only)

3. *Optional.* You can enable alarm sound that goes off if the measurement falls outside of the limit. Toggle the **Beep** soft key between **On** and **Off** to enable or disable the beep sound.
4. *Optional.* Go to **SAVE/LOAD > Save**, and then select **Limit** to save the limit settings. See “Using save” on page 31 for more information.

Measurement example

Figure 42 Modulation analyzer measurement with GSM OTA signal analyzer



Using WCDMA/HSPA+ Signal Analyzer

This chapter provides instructions for using the WCDMA/HSPA+ Signal Analyzer function (option 023) with the WCDMA/HSPA+ OTA Analyzer function (option 043). Topics discussed in this chapter are as follows:

■ Introduction	134
■ Display overview	134
■ Connecting a cable	135
■ Selecting measurement mode	137
■ Configuring test parameters	137
■ Conducting spectrum measurements	142
■ Conducting RF measurements	143
■ Conducting modulation measurements	151
■ Performing auto measurements	163
■ Performing power statistics CCDF measurement	165
■ Conducting WCDMA/HSPA+ OTA measurements	166

Introduction

This WCDMA/HSPA+ Signal Analyzer can be used to test a WCDMA transmitter including HSDPA/HSPA+ signals to check the base station's compliance with following standards documentation.

- 3GPP TS 25.104 Base Station radio transmission and reception
- 3GPP TS 25.141 Base Station (BS) conformance test
- 3GPP TS 25.211 Physical channel and mapping of transport channels onto physical channels
- 3GPP TS 25.212 Multiplexing and channel coding
- 3GPP TS 25.213 Spreading and modulation

The instrument automatically makes standard defined measurements using the measurement methods and limits as defined in the standards. Detailed measurement results allow you to analyze WCDMA and HSPA+ system performance. You may alter the measurement parameters for specialized analysis. Pass/Fail testing with standard defined or user defined upper and lower limits and the Pass/Fail indicator help you to determine base station performance easily.

This instrument provides the following measurement tools for WCDMA/HSPA+ system:

- Spectrum Analysis
- RF Analysis
 - Channel Power
 - Occupied Bandwidth
 - Spectrum Emission Mask (SEM)
 - Adjacent Channel Leakage power Ratio (ACLR)
 - Multi-ACLR
 - Spurious Emissions
- Modulation Analysis
 - Constellation
 - Code Domain Power
 - Relative Code Domain Error
 - Codogram
 - Received Code Strength Indicator (RCSI)
 - CDP Table
- Auto Measure
- Power Statistics CCDF
- Over The Air (OTA)
 - Channel Scanner
 - Scramble Scanner
 - Multipath Profile
 - Code Domain Power
 - Route Map

Display overview

Figure 43 provides descriptions for each segment of the measurement screen.

Figure 43 WCDMA/HSPA+ signal analyzer measurement screen

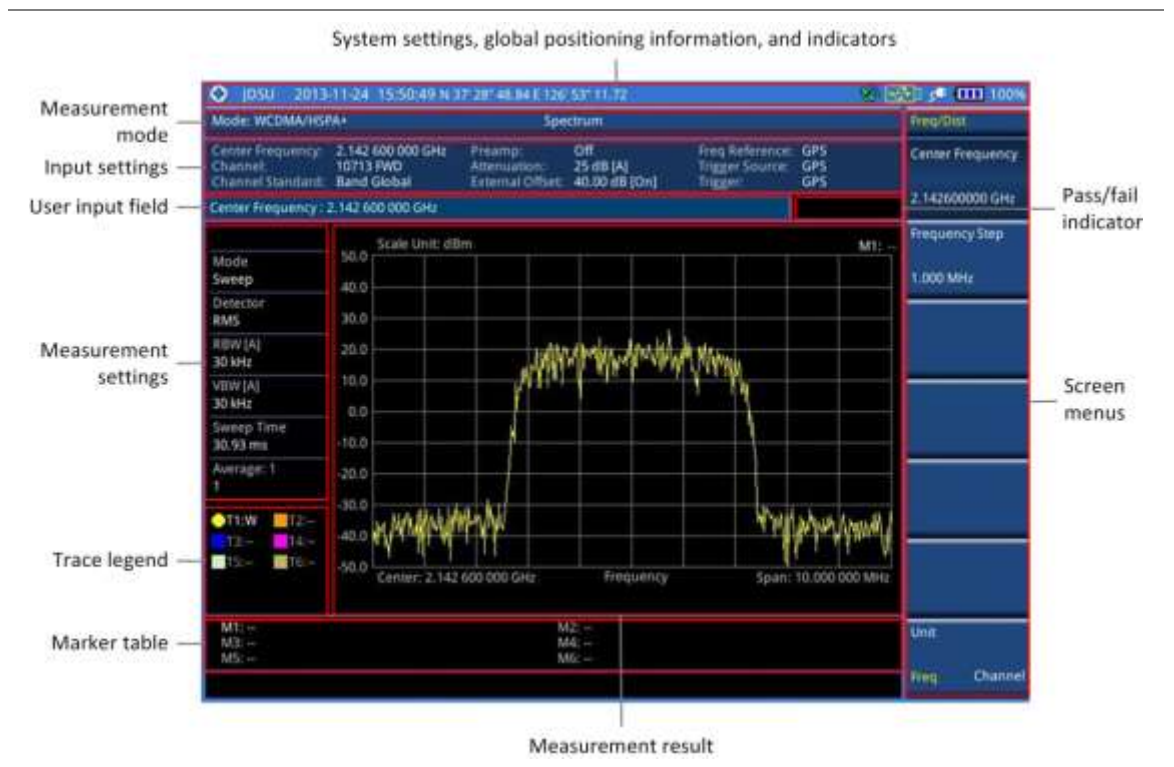

Connecting a cable

Direct connection

Procedure

1. Connect the **Spectrum Analyzer RF In** port of the JD780A series and the power amplifier output port of BTS.

Figure 44 Direct connection



Indirect connection

Procedure

1. Connect the **Spectrum Analyzer RF In** port of the JD780A series and the monitor (test) port of BTS.

Figure 45 Indirect connection

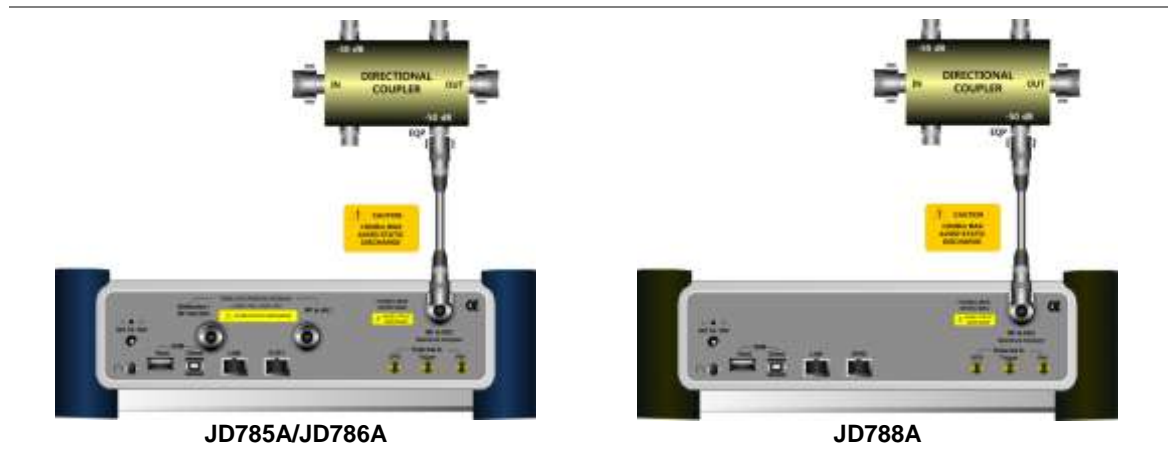

CAUTION
 The maximum power for the **Spectrum Analyzer RF In** port is +25 dBm (0.316 W). If the input signal level to be measured is greater than +25 dBm, use a **High Power Attenuator** to prevent damage when you directly connect the signal to the instrument or connect the signal from the coupling port of a directional coupler.

Over the air (OTA)

Procedure

1. Connect an Omni/directional RF antenna to the **Spectrum Analyzer RF In** port of the JD780A series.
2. Connect a GPS antenna to the **GPS** port of the JD780A series.

Figure 46 OTA connection

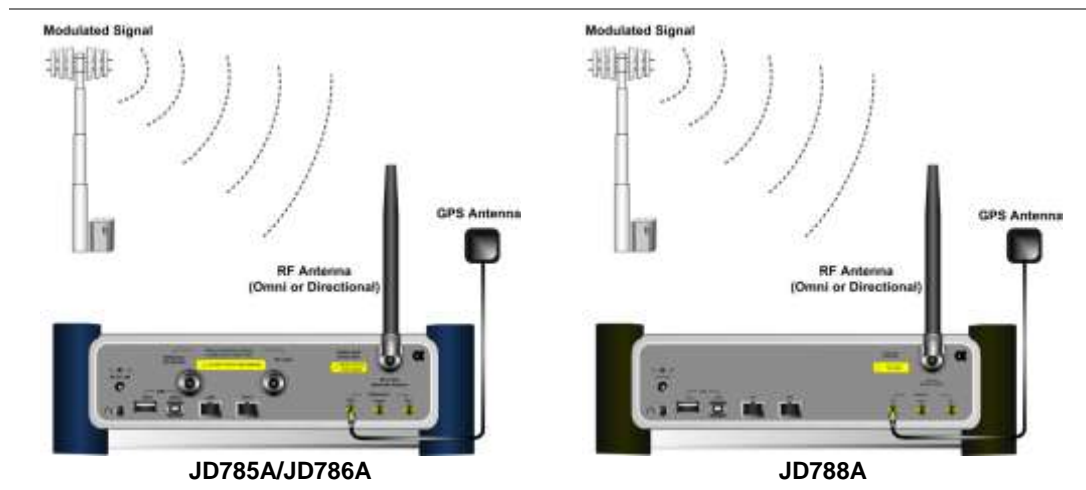

CAUTION
 If the input signal level to be measured is less than 0 dBm, set 0 dB attenuation or turn on the preamp to have better dynamic range for the OTA testing.

Selecting measurement mode

Procedure

1. Press the **MODE** hard key.
 2. Press the **Signal Analyzer** soft key.
 3. Press the **WCDMA** soft key. The **Spectrum** mode is set by default.
 4. Press the **MEASURE** hot key, and then select the measurement mode option from the following choices:
 - Spectrum
 - RF Analysis > Channel Power, Occupied BW, Spectrum Emission Mask, ACLR, Multi-ACLR, or Spurious Emissions
 - Modulation > Constellation, Code Domain Power, Relative Code Domain Error, Codogram, RCSI, or CDP Table
 - Auto Measure
 - Power Statistics CCDF
 - OTA > Channel Scanner, Scramble Scanner, Multipath Profile, Code Domain Power, or Route Map
-

Configuring test parameters

Setting frequency

You can set the frequency with either frequency or channel number. If a frequency to be set matches to the frequency corresponding to the selected channel standard, the instrument calculates its channel number and updates the screen with it automatically.

Procedure

To set the center frequency:

1. Press the **FREQ/DIST** hard key.
2. Toggle the **Unit** soft key and select **Freq.**
3. Press the **Center Frequency** soft key.
4. Enter a value by using the numeric keys. You can also use the rotary knob.
5. Select the unit: **GHz**, **MHz**, **kHz**, or **Hz**.
6. *Optional.* To define the amount of frequency increment for the rotary knob, complete the following steps:
 - a. Press the **Frequency Step** soft key.
 - b. Enter a value by using the numeric keys. You can also use the rotary knob.
 - c. Press the unit: **GHz**, **MHz**, **kHz**, or **Hz**.

To set the channel number:

1. Press the **FREQ/DIST** hard key.
 2. Toggle the **Unit** soft key and select **Channel**.
 3. To select the standard channel, complete the following steps:
 - a. Press the **Channel Std** soft key. The standard channel window appears. See “Appendix C – Band, frequency & channel standard” on page 541 for more information.
-

- b. Select the band to be measured by using the rotary knob, the arrow keys, or the **Page Up/Page Down** soft keys.
 - c. Press the **Select** soft key or the rotary knob to confirm the selection.
4. Press the **Channel Number** soft key.
5. Enter a value by using the numeric keys. You can also use the rotary knob.
6. Press the **Enter** soft key.

The instrument automatically displays the corresponding center frequency value for the selected channel number.

7. *Optional.* To define the amount of channel increment for the rotary knob, complete the following steps:
 - a. Press the **Channel Step** soft key.
 - b. Enter a value by using the numeric keys. You can also use the rotary knob.
 - c. Press the **Enter** soft key.

NOTE

This frequency setting is not used in the Multi-ACLR and Spurious Emissions modes.

Setting amplitude

Reference level and attenuation

You can set the reference and attenuation levels automatically or manually to optimize the display of the traces measured, as you desire.

Procedure

To automatically set the reference and attenuation level:

1. Press the **AMP/SCALE** hard key.
2. Press the **Auto Scale** soft key.
Each time you press this key, both of the Y-axis scale and input attenuation level change to be optimized with some margin.

To set the reference or attenuation level manually:

1. Press the **AMP/SCALE** hard key.
2. To set the maximum reference value on the Y-axis manually, complete the following steps:
 - a. Press the **Reference Level** soft key.
 - b. Enter a value by using the numeric keys or the rotary knob with 10 dB increments.
 - c. Press the **dBm** soft key or the **ENTER** hard key.

NOTE

In the measurements such as **Code Domain Power**, **Codogram**, and **RCSI**, you may need to select the reference option between **Relative** and **Absolute** before setting the reference level.

3. To set the attenuation option, select one from the following choices:
 - To set the input attenuator's level automatically, select **Attenuation > Auto**.

NOTE

It is recommended that you set the **Attenuation** to **Auto** in most situations so that the level of the input attenuator can be set automatically according to your input signal level.

- To set the input attenuation manually up to 55 dB to optimize S/N, complete the following

steps:

- a. Select **Attenuation > Manual**.
 - b. Press the **Attenuation Value** soft key to set the level.
 - c. Enter a value between 0 and 55 in fives by using the numeric keys.
 - d. Press the **dB** soft key or the **ENTER** hard key.
- To couple the input attenuator's level with your reference level setting, select **Attenuation > Couple**.
As you increase the reference setting, the attenuation level also increases accordingly.

Optional. To change the scale unit:

1. Select **More (1/2) > Units**.
2. Select the unit of the display scale: **dBm**, **dBV**, **dBmV**, **dBμV**, **V**, or **W**.
The scale unit on the screen changes accordingly.

NOTE

This Units menu is available in the Spectrum and RF Analysis modes.

Scale per division

You can use the **Scale/Div** feature available for the spectrum and RF analysis. It represents the value of one division on the horizontal scale. The default setting is 10 dB per division and the maximum value can be set up to 20 dB.

Procedure

To set the scale per division:

1. Press the **AMP/SCALE** hard key.
 2. Select **More (1/2) > Scale/Div**.
 3. Enter a value between 1 and 20 by using the numeric keys.
 4. Press the **dB** soft key to complete the entry.
-

Pre-amplifier

You can turn the internal pre-amplifier on to correct and compensate for the gain of the preamp so that amplitude readings show the value at the input connector.

Procedure

1. Press the **AMP/SCALE** hard key.
 2. Toggle the **Preamp** soft key and select **On** or **Off** as needed.
-

NOTE

You can turn the Preamp on when the input attenuation range is from 0 dB to 10 dB. If the attenuation value is manually set to greater than 10 dB, the instrument will automatically turn off the pre-amplifier to display low-level signal properly on the chart.

External offset

You can turn the **External Offset** on and manually set the external offset value. An offset consists of a cable loss and a user offset and the measurement result shows the value reflecting both offset values.

When the external offset value is set at 40 dB in the Spectrum mode, the measurement result compensates 40 dB at both the Spectrum Analyzer and Signal Analyzer modes

Procedure

To set the external offset:

1. Press the **AMP/SCALE** hard key.
2. Toggle the **External Offset** soft key and select **On**.
3. Enter a value by using the numeric keys.
4. Press the **dB** soft key to complete the entry.

To turn the external offset off:

1. Press the **AMP/SCALE** hard key.
 2. Toggle the **External Offset** soft key and select **Off**.
-

Setting average

You can set the number of measurements to be averaged for the trace presentation. A maximum of 100 times of averaging can be set. When the averaging reaches to your setting, a new measurement value replaces the measurement value in sequence from the earliest.

Procedure

1. Press the **BW/AVG** hard key.
 2. Press the **Average** soft key.
 3. Enter a value between 1 and 100 as needed by using the numeric keys.
 4. Press the **Enter** soft key.
-

Setting sweep mode

The default settings of the sweep mode are **Continue** and **Normal** to sweep continuously at a normal speed for most on-going measurements. If you want to hold the measurement or get a single sweep, you can change the sweep mode.

Procedure

To select the single sweep mode:

1. Press the **SWEEP** hot key.
2. Toggle the **Sweep Mode** soft key and select **Single**. You can also use the **HOLD** hot key. The letter **HOLD** in red appears and the sweeping is paused.
3. *Optional.* Press the **Sweep Once** soft key to get a new measurement.

To return to the continuous sweep mode:

1. Toggle the **Sweep Mode** soft key and select **Continue**. You can also use the **HOLD** hot key. The letter **HOLD** in red disappears and the sweeping resumes.
-

Setting trigger source

You can set the trigger source option for your measurements.

Procedure

1. Press the **TRIGGER** hot key.
2. Select the trigger source option from the following choices: **Internal**, **External**, or **GPS**.

Setting external clock

To enhance the reliability of modulation analysis measurements the JD780A series must be synchronized with a base station. When an external clock is not supplied, the instrument works with its built-in internal high-accuracy time base and some measurement results may exhibit inaccurate values. Therefore, it is highly recommended that you use the same reference clock as the signal source. You can use the **TRIGGER** hot key to set the external clock.

Table 12 Standards of external clock operation

Clock	Type	Reference	Port	Switching Standard
External Reference	Internal	Internal 10 MHz		Default
	External	External Ref Clock	Ext Ref (SMA)	Manual switching (Input signal level >-3 dBm)
	GPS	GPS Clock	GPS (SMA)	Automatic switching (GPS signal received)
Trigger	Internal	Internal Trigger		Default
	External	External Trigger	Trigger (SMA)	Manual switching
	GPS	GPS	GPS (SMA)	Manual switching

Figure 47 Connection ports for external reference clock









Procedure

1. Connect an external reference or a GPS antenna to the JD780A series.
2. Press the **SYSTEM** hot key.
3. Press the **Freq Reference** soft key, and then select the reference option: **Internal**, **External 10 MHz**, **External 13 MHz**, **External 15 MHz**, or **GPS**.

NOTE

When a GPS antenna is connected and locked, GPS coordinates (longitude and latitude) are displayed on the screen and frequency reference is automatically set to GPS in the **System > Freq Reference**.

Table 13 External reference indicators

Type	Indicator	Description
Internal	 (green)	The green INT icon indicates that the instrument uses the built-in internal time base.
External	 (green)	The green EXT icon indicates that an external reference is connected and locked and that the instrument uses the same reference clock as the signal source.
External	 (red)	The red EXT icon indicates that an external reference is connect but not locked.
GPS	 (green)	The green GPS antenna icon indicates that a GPS antenna is connected and locked.
GPS	 (yellow)	The yellow GPS antenna icon indicates that a GPS antenna is connected and locking is in progress.
GPS	 (grey)	The grey GPS antenna icon indicates that a GPS antenna is not connected, failed, or unable to be locked.

Conducting spectrum measurements

If you have configured test parameters as described in the “Configuring test parameters” on page 137, your measurement result is displayed on the screen as like the following example, Figure 48.

Figure 48 Spectrum measurement screen with WCDMA signal analyzer

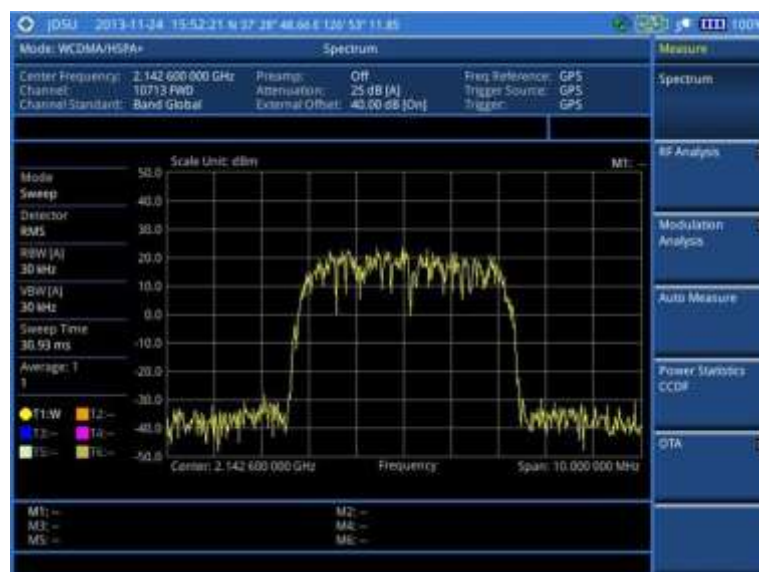

Setting trace

You can display up to six traces on the measurement chart simultaneously.

Procedure

1. Press the **TRACE/DISPLAY** hard key.
2. Press the **Select Trace** soft key, and then select the trace number: **T1**, **T2**, **T3**, **T4**, **T5**, or **T6**. The legend shape of the selected trace changes from square to round to indicate that the trace is

the active one now.

3. Toggle the **Trace View** soft key and select **On**.
4. To clear, write or capture, or hide the trace(s), do one of the following:

To	Select	Trace Legend
Clear current data and display with new measurements	Clear Write	W
Display the input signal's maximum response only	Max Hold	M
Display the input signal's minimum response only	Min Hold	m
Capture the selected trace and compare traces	Capture	C
Load a saved trace	More (1/2) > Load	L
Hide the selected trace	Trace View > Off	F
Remove all the traces and initialize the trace settings	More (1/2) > Trace Clear All	

5. To select the detection option, press the **More (1/2) > Detectors**, and then do one of the following:

To display	Select
Random noise better than the peak without missing signals	Normal
The highest value in each data point	Peak
The root mean squared average power across the spectrum	RMS
The lowest value in each data point	Negative Peak
The center value in each data point	Sample

6. *Optional.* Press the **More (1/2) > Trace Info** soft key, and then select the trace number to view the trace's parameter setting information stored at the time of the measurement or **None** to hide the information display.
7. *Optional.* If you have the two traces T1 and T2, you can perform trace math. To view the power difference between the traces, press the **T1 – T2 -> T5** or **T2 – T1 -> T6** soft key. The result is overlaid on the screen along with the second Y-axis.

Conducting RF measurements

Channel power

The Channel Power measurement is a common test used in the wireless industry to measure the total transmitted power of a radio within a defined frequency channel. This procedure measures the total power within the defined channel for WCDMA. This measurement is applied to design, characterize, evaluate, and verify transmitters and their components or devices for base stations and mobile stations.

The channel power measurement identifies the channel power within a specified bandwidth (default is 5 MHz, as per the 3GPP WCDMA technical specifications) and the power spectral density (PSD) in dBm/Hz.

After configuring test parameters as described in the “Configuring test parameters” on page 137, your measurement result is displayed on the screen as like the following example, Figure 49.

Figure 49 Channel power measurement with WCDMA/HSPA+ signal analyzer



NOTE
 You can use the **LIMIT** hot key to analyze your measurements with the user-definable limit and Pass/Fail indication. See “Setting limit for RF tests” on page 150 for more information.

Occupied bandwidth

The 3GPP specifications require the occupied bandwidth (OBW) of a transmitted WCDMA signal to be less than 5 MHz, where occupied bandwidth is defined as the bandwidth containing 99% of the total channel power. In this measurement, the total power of the displayed span is measured. Then the power is measured inward from the right and left extremes until 0.5% of the power is accounted for each of the upper and lower part of the span and the calculated difference is the occupied bandwidth.

The spectrum shape of a WCDMA signal can give a useful qualitative insight into the transmitter’s operation. Any distortion to the spectrum shape might be an indication of degradation of the transmitter’s performance.

After configuring test parameters as described in the “Configuring test parameters” on page 137, your measurement result is displayed on the screen as like the following example, Figure 50.

Figure 50 Occupied bandwidth measurement with WCDMA/HSPA+ signal analyzer



NOTE

You can use the **LIMIT** hot key to analyze your measurements with the user-definable limit and Pass/Fail indication. See “Setting limit for RF tests” on page 150 for more information.

Spectrum emission mask (SEM)

The Spectrum Emission Mask (SEM) measurement required by 3GPP specifications encompasses different power limits and different measurement bandwidths (resolution bandwidths) at various frequency offsets. It may be expressed as a ratio of power spectral densities between the carrier and the specified offset frequency band. It provides useful figures-of-merit for the spectral re-growth and emissions produced by components and circuit blocks, without the rigor of performing a full SEM measurement.

The SEM measures spurious signal levels in up to five pairs of offset or region frequencies and relates them to the carrier power.

Setting measure setup

After configuring test parameters as described in the “Configuring test parameters” on page 137, you can set the mask type according to the output power of the base station to be tested. Your measurement result is displayed on the screen as like the following example, Figure 51.

Procedure

1. Press the **MEASURE SETUP** hot key.
2. Press the **Mask Type** soft key.
3. Select the mask type option: **- 31 dBm, 31 - 39 dBm, 39 - 43 dBm, or 49 dBm -**.

Figure 51 SEM measurement with WCDMA/HSPA+ signal analyzer



NOTE
 You can use the **LIMIT** hot key to analyze your measurements with the user-definable limit and Pass/Fail indication. See “Setting limit for RF tests” on page 150 for more information.

ACLR

The Adjacent Channel Power Ratio (ACPR), designated by the 3GPP WCDMA specifications as the Adjacent Channel Leakage power Ratio (ACLR), is the power contained in a specified frequency channel bandwidth relative to the total carrier power. It may also be expressed as a ratio of power spectral densities between the carrier and the specified offset frequency band.

After configuring test parameters as described in the “Configuring test parameters” on page 137, your measurement result is displayed on the screen as like the following example, Figure 52.

Figure 52 ACLR measurement with WCDMA/HSPA+ signal analyzer



NOTE

You can use the **LIMIT** hot key to analyze your measurements with the user-definable limit and Pass/Fail indication. See “Setting limit for RF tests” on page 150 for more information.

Multi-ACLR

The Multi-ACLR measurement is used to perform multi-channel ACLR measurements with as many channels as possible. It helps you to measure ACLR in multi-channel transmitting Base Station environment.

Setting frequency for Multi-ACLR

You can set the frequency with either frequency or channel number.

Procedure

1. Press the **MEASURE SETUP** hot key.
 2. To set the frequency, do one of the following:
 - To set the center frequency, complete the following steps:
 - a. Toggle the **Unit** soft key and select **Freq.**
 - b. Press the **Lowest Frequency** soft key to set the starting center frequency.
 - c. Enter a value by using the numeric keys. You can also use the rotary knob.
 - d. Select the unit: **GHz, MHz, kHz, or Hz.**
 - e. Press the **Highest Frequency** soft key to set the stopping center frequency.
 - f. Enter a value by using the numeric keys. You can also use the rotary knob.
 - g. Select the unit: **GHz, MHz, kHz, or Hz.**
 - To set the channel number, complete the following steps:
 - a. Toggle the **Unit** soft key and select **Channel.**
 - b. To select the standard channel, press the **Channel Std** soft key and then select the band to be measured.
 - c. Press the **Lowest Channel** soft key to set the starting channel.
 - d. Enter a value by using the numeric keys. You can also use the rotary knob.
 - e. Press the **Enter** soft key.
 - f. Press the **Highest Channel** soft key to set the stopping channel.
 - g. Enter a value by using the numeric keys. You can also use the rotary knob.
 - h. Press the **Enter** soft key.
-

After configuring test parameters, your measurement result is displayed on the screen as like the following example, **Figure 53**.

Figure 53 Multi-ACLR measurement with WCDMA/HSPA+ signal analyzer



NOTE

You can use the **LIMIT** hot key to analyze your measurements with the user-definable limit and Pass/Fail indication. See “Setting limit for RF tests” on page 150 for more information.

Spurious emissions

Out-of-band emissions are unwanted emissions immediately outside the channel bandwidth resulting from the modulation process and non-linearity in the transmitter but excluding spurious emissions. The Spurious Emissions measurement is to identify and determine the power level of out-of-band spurious emission within the necessary channel bandwidth and modulated signal measured at the RF port of the Base Station.

Setting measure setup

Procedure

1. Press the **MEASURE SETUP** hot key.
2. To set up the range table and frequency range, press the **Range Table** soft key and then complete the following steps:
 - a. Press the **Range** soft key, and then enter the range number to add a new range or change an existing one.
 - b. Press the **Enter** soft key.
 - c. Press the **Start Frequency** soft key to set up the frequency range.
 - d. Enter a value by using the numeric keys. You can also use the rotary knob.
 - e. Select the unit: **GHz**, **MHz**, **kHz**, or **Hz**.
 - f. Press the **Stop Frequency** soft key to set up the frequency range.
 - g. Enter a value by using the numeric keys. You can also use the rotary knob.
 - h. Select the unit: **GHz**, **MHz**, **kHz**, or **Hz**.
3. Toggle the **Range** soft key between **On** and **Off** to display or hide the selected range.
4. To set up the test limits for Pass/Fail indication, complete the following steps:

-
- a. Press the **Start Limit** soft key.
 - b. Enter a value by using the numeric keys. You can also use the rotary knob.
 - c. Select the **dBm** soft key.
 - d. Press the **Stop Limit** soft key.
 - e. Enter a value by using the numeric keys. You can also use the rotary knob.
 - f. Select the **dBm** soft key.
5. To set up the other parameters, complete the following steps:
- a. Select **More (1/2) > Attenuation** to set up the attenuation value.
 - b. Enter a value in the multiple of five.
 - c. Press the **dB** soft key or the **ENTER** hard key.
 - d. Press the **RBW** soft key.
 - e. Enter a value by using the numeric keys.
 - f. Select the unit: **GHz**, **MHz**, **kHz**, or **Hz**.
 - g. Press the **VBW** soft key.
 - h. Enter a value by using the numeric keys.
 - i. Select the unit: **GHz**, **MHz**, **kHz**, or **Hz**.
6. Press the **PREV** hard key.
7. Toggle the **Measure Type** soft key between **Examine** and **Full** to select the measurement type.

NOTE

The **Examine** mode displays only the selected range while the **Full** mode lets the instrument automatically change the selected range from one another.

8. Set the number of measurements to be averaged:
- a. Press the **Average** soft key.
 - b. Enter a value between 1 and 100.
 - c. Press the **Enter** soft key.

After configuring test parameters as described in the “Configuring test parameters” on page 137, your measurement result is displayed on the screen as like the following example, Figure 54.

Figure 54 Spurious emissions measurement with WCDMA/HSPA+ signal analyzer



NOTE

You can use the **LIMIT** hot key to analyze your measurements with the user-definable limit and Pass/Fail indication. See “Setting limit for RF tests” on page 150 for more information.

Setting limit for RF tests

By default, test limits specified in the standard are set for you. You can change thresholds if you desire.

Procedure

1. Press the **LIMIT** hot key.
2. Press the **RF Test Limits** soft key.
3. Select the test item(s) and set the limit(s) depending on your selected measurement mode:

To set the limit for	Select	Set
Channel power	Channel Power	High Limit Low Limit
Occupied bandwidth	Occupied BW	High Limit
Spectrum emission mask	Spectrum Emission Mask	(On/Off only)
ACLR	ACLR	(On/Off only)
Multi-ACLR	Multi-ACLR	(On/Off only)
Spurious emissions	Spurious Emissions	(On/Off only)

4. *Optional.* You can enable alarm sound that goes off if the measurement falls outside of the limit. Toggle the **Beep** soft key between **On** and **Off** to enable or disable the beep sound.
5. *Optional.* Go to **SAVE/LOAD > Save**, and then select **Limit** to save the limit settings. See “Using save” on page 31 for more information.

Conducting modulation measurements

Constellation

The Constellation is used to observe some aspects of modulation accuracy and can reveal certain fault mechanisms such as I/Q amplitude imbalance or quadrature imbalance. It displays constellation diagram by modulation types.

Setting measure setup

After configuring test parameters as described in the “Configuring test parameters” on page 137, you can continue your measurement. The measurement settings can be saved and recalled as a file.

Procedure

1. Press the **MEASURE SETUP** hot key.
2. To set the scramble code, complete the following steps:
 - a. Toggle the **Scramble** soft key between **Auto** and **Manual**.
 - b. Enter a value by using the numeric keys to set manually.
 - c. Press the **Enter** soft key.
3. Press the **Detect Mode** soft key, and then select the signal standard option: **WCDMA**, **HSDPA**, or **HSPA+**. HSDPA is set by default.
4. To set the threshold, complete the following steps:
 - a. Press the **Threshold** soft key.
 - b. Enter a value by using the numeric keys.
 - c. Press the **Enter** soft key.

Measurement example

Figure 55 Constellation measurement with WCDMA/HSPA+ signal analyzer

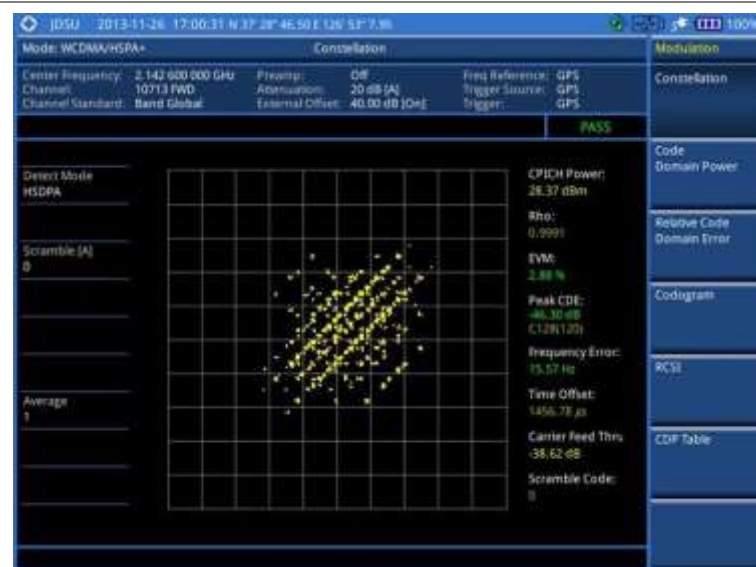

NOTE

You can use the **LIMIT** hot key to analyze your measurements with the user-definable limit and Pass/Fail indication. See “Setting limit for modulation tests” on page 162 for more information.

Code domain power

The Code Domain Power (CDP) measures the distribution of power across the set of code channels, normalized to the total power. It helps to verify that each code channel is operating at its proper level and to identify problems throughout the transmitter design from coding to the RF section. System imperfections such as amplifier non-linearity will present themselves as an undesired distribution of power in the code domain.

Setting measure setup

After configuring test parameters as described in the “Configuring test parameters” on page 137, you can continue your measurement. The measurement settings can be saved and recalled as a file. You can also use JDViewer, PC application software to configure a measure setup, save as a file, and load the file on to the instrument.

Procedure

1. Press the **MEASURE SETUP** hot key.
 2. *Optional.* To set the scramble code, complete the following steps:
 - a. Toggle the **Scramble** soft key between **Auto** and **Manual**.
 - b. Enter a value by using the numeric keys to set manually.
 - c. Press the **Enter** soft key.
 3. *Optional.* Press the **Detect Mode** soft key, and then select the signal standard option: **WCDMA**, **HSDPA**, or **HSPA+**. HSDPA is set by default.
 4. To set the S-CCPCH information of the system to be tested, complete the following steps:
 - a. Press the **S-CCPCH** soft key.
 - b. Toggle the **S-CCPCH** soft key between **On** and **Off** to enable or disable the S-CCPCH.
 - c. Press the **Spread Factor** soft key, and then select the spread factor option: **4**, **8**, **16**, **32**, **64**, **128**, or **256**.
 - d. Press the **Spread Code** soft key to set the spread code.
 - e. Enter a value by using the numeric keys.
 - f. Press the **Enter** soft key.
 5. To set the PICH information of the system to be tested, complete the following steps:
 - a. Press the **PICH** soft key.
 - b. Toggle the **PICH** soft key between **On** and **Off** to enable or disable the PICH.
 - c. Press the **Spread Factor** soft key, and then select the spread factor option: **4**, **8**, **16**, **32**, **64**, **128**, or **256**.
 - d. Press the **Spread Code** soft key to set the spread code.
 - e. Enter a value by using the numeric keys.
 - f. Press the **Enter** soft key.
 6. *Optional.* To set the threshold, complete the following steps:
 - a. Press the **Threshold** soft key.
 - b. Enter a value by using the numeric keys.
 - c. Press the **Enter** soft key.
-

Measurement example

Figure 56 Code domain power measurement with WCDMA/HSPA+ signal analyzer

1) Full screen



2) Full screen with constellation



3) Zoomed screen (Width 64)



4) Zoomed screen with constellation (Width 64)



NOTE

You can use the **LIMIT** hot key to analyze your measurements with the user-definable limit and Pass/Fail indication. See “Setting limit for modulation tests” on page 162 for more information.

Setting display

You can view your measurement results in a different view option.

Procedure

1. Press the **TRACE/DISPLAY** hard key.
2. Toggle the **View** soft key and select the display option:
 - **Zoom**: to view the result in detail with zoom-in window. The Position and Width menus become activated.

-
- **Full**: to view the full measurement result.
3. To define the zoom start position and width, complete the following steps:
 - a. Press the **Position** soft key.
 - b. Enter a value of the position by using the numeric keys.
 - c. Press the **Enter** soft key.
 - d. Press the **Width** soft key, and then select the Walsh code option: **32, 64, 128, or 256**.
 4. Toggle the **Constellation** soft key between **On** and **Off** to enable or disable the constellation chart on the Code Domain Power screen.
 5. Toggle the **Control Channel** soft key and select the control channel mode option:
 - **Normal**: to view the relative ratio of each control channel vs. total power.
 - **Delta**: to view the relative ratio of each control channel vs. CPICH channel.
-

Relative code domain power

The Relative Code Domain Error (RCDE) measurement provides relative code domain error analysis that is particularly required by HSPA+.

Setting measure setup

After configuring test parameters as described in the “Configuring test parameters” on page 137, you can continue your measurement. The measurement settings can be saved and recalled as a file. You can also use JDViewer, PC application software to configure a measure setup, save as a file, and load the file on to the instrument.

Procedure

1. Press the **MEASURE SETUP** hot key.
2. *Optional.* To set the scramble code, complete the following steps:
 - a. Toggle the **Scramble** soft key between **Auto** and **Manual**.
 - b. Enter a value by using the numeric keys to set manually.
 - c. Press the **Enter** soft key.
3. *Optional.* Press the **Detect Mode** soft key, and then select the signal standard option: **WCDMA, HSDPA, or HSPA+**. HSDPA is set by default.

NOTE

It is recommended that you select **HSPA+** for RCDE testing.

4. To set the S-CCPCH information of the system to be tested, complete the following steps:
 - a. Press the **S-CCPCH** soft key.
 - b. Toggle the **S-CCPCH** soft key between **On** and **Off** to enable or disable the S-CCPCH.
 - c. Press the **Spread Factor** soft key, and then select the spread factor option: **4, 8, 16, 32, 64, 128, or 256**.
 - d. Press the **Spread Code** soft key to set the spread code.
 - e. Enter a value by using the numeric keys.
 - f. Press the **Enter** soft key.
 5. To set the PICH information of the system to be tested, complete the following steps:
-

- a. Press the **PICH** soft key.
 - b. Toggle the **PICH** soft key between **On** and **Off** to enable or disable the PICH.
 - c. Press the **Spread Factor** soft key, and then select the spread factor option: **4, 8, 16, 32, 64, 128, or 256**.
 - d. Press the **Spread Code** soft key to set the spread code.
 - e. Enter a value by using the numeric keys.
 - f. Press the **Enter** soft key.
6. *Optional.* To set the threshold, complete the following steps:
 - a. Press the **Threshold** soft key.
 - b. Enter a value by using the numeric keys.
 - c. Press the **Enter** soft key.
 7. *Optional.* Go to **SAVE/LOAD > Save**, and then select the save option from the choices available for your measurement mode. See “Using save” on page 31 for more information.

Measurement example

Figure 57 Relative code domain error with WCDMA/HSPA+ signal analyzer



NOTE

You can use the **LIMIT** hot key to analyze your measurements with the user-definable limit and Pass/Fail indication. See “Setting limit for modulation tests” on page 162 for more information.

Setting display

You can view your measurement results in a different view option.

Procedure

1. Press the **TRACE/DISPLAY** hard key.
2. Toggle the **View** soft key and select the display option:
 - **Zoom**: to view the result in detail with zoom-in window.

-
- The Position and Width menus become activated.
- **Full:** to view the full measurement result.
3. To define the zoom start position and width, complete the following steps:
 - a. Press the **Position** soft key.
 - b. Enter a value of the position by using the numeric keys.
 - c. Press the **Enter** soft key.
 - d. Press the **Width** soft key, and then select the Walsh code option: **32, 64, 128, or 256**.
 4. Toggle the **Constellation** soft key between **On** and **Off** to enable or disable the constellation chart on the Code Domain Power screen.
 5. Toggle the **Control Channel** soft key and select the control channel mode option:
 - **Normal:** to view the relative ratio of each control channel vs. total power.
 - **Delta:** to view the relative ratio of each control channel vs. CPICH channel.
-

Codogram

The Codogram displays how the code level is changing over time and makes it easier for you to view traffic channels as they initiate and terminate and to track traffic channels call levels over time. The Codogram measurements can be saved into an external USB memory so that a post-analysis can be done with the application software JDViewer.

Setting measure setup

After configuring test parameters as described in the “Configuring test parameters” on page 137, you can continue your measurement. The measurement settings can be saved and recalled as a file. You can also use JDViewer, PC application software to configure a measure setup, save as a file, and load the file on to the instrument.

Procedure

1. Press the **MEASURE SETUP** hot key.
 2. *Optional.* To set the scramble code, complete the following steps:
 - a. Toggle the **Scramble** soft key between **Auto** and **Manual**.
 - b. Enter a value by using the numeric keys to set manually.
 - c. Press the **Enter** soft key.
 3. *Optional.* Press the **Detect Mode** soft key, and then select the signal standard option: **WCDMA, HSDPA, or HSPA+**. HSDPA is set by default.
 4. To set the S-CCPCH information of the system to be tested, complete the following steps:
 - a. Press the **S-CCPCH** soft key.
 - b. Toggle the **S-CCPCH** soft key between **On** and **Off** to enable or disable the S-CCPCH.
 - c. Press the **Spread Factor** soft key, and then select the spread factor option: **4, 8, 16, 32, 64, 128, or 256**.
 - d. Press the **Spread Code** soft key to set the spread code.
 - e. Enter a value by using the numeric keys.
 - f. Press the **Enter** soft key.
 5. To set the PICH information of the system to be tested, complete the following steps:
 - a. Press the **PICH** soft key.
-

- b. Toggle the **PICH** soft key between **On** and **Off** to enable or disable the PICH.
 - c. Press the **Spread Factor** soft key, and then select the spread factor option: **4, 8, 16, 32, 64, 128, or 256**.
 - d. Press the **Spread Code** soft key to set the spread code.
 - e. Enter a value by using the numeric keys.
 - f. Press the **Enter** soft key.
6. *Optional.* To set the threshold, complete the following steps:
- a. Press the **Threshold** soft key.
 - b. Enter a value by using the numeric keys.
 - c. Press the **Enter** soft key.
7. To set the time interval, complete the following steps:
- a. Press the **Time Interval** soft key.
 - b. Enter a value by using the numeric keys.
 - c. Press the **Enter** soft key.
8. To place the time cursor to analyze your measurements, complete the following steps:
- a. Toggle the **Time Cursor** soft key between **On** and **Off** to enable or disable the time cursor.
 - b. Enter a value by using the numeric keys.
 - c. Press the **Enter** soft key.

NOTE

When the time cursor is enabled, the measurement is put on hold and information about the time cursor is displayed.

9. *Optional.* Go to **SAVE/LOAD > Save**, and then select the save option from the choices available for your measurement mode. See “Using save” on page 31 for more information.

Measurement example

Figure 58 Codogram in full view with WCDMA/HSPA+ signal analyzer



Setting display

You can view your measurement results in a different view option.

Procedure

1. Press the **TRACE/DISPLAY** hard key.
 2. Toggle the **View** soft key and select the display option:
 - **Zoom**: to view the result in detail with zoom-in window. The Position and Width menus become activated.
 - **Full**: to view the full measurement result.
 3. To define the zoom start position and width, complete the following steps:
 - a. Press the **Position** soft key.
 - b. Enter a value of the position by using the numeric keys.
 - c. Press the **Enter** soft key.
 - d. Press the **Width** soft key, and then select the Walsh code option: **32, 64, 128, or 256**.
-

RCSI

The Received Code Strength indicator (RCSI) is used to track the code channels such as CPICH, P-CCPCH, S-CCPCH, PICH, P-SCH, and S-SCH. It is particularly useful to observe signal fluctuations of the dedicated control channels over the time. The RCSI measurements can be saved into an external USB memory so that a post-analysis can be done with the application software JDViewer.

Setting measure setup

After configuring test parameters as described in the “Configuring test parameters” on page 137, you can continue your measurement. The measurement settings can be saved and recalled as a file. You can also use JDViewer, PC application software to configure a measure setup, save as a file, and load the file on to the instrument.

Procedure

1. Press the **MEASURE SETUP** hot key.
 2. *Optional.* To set the scramble code, complete the following steps:
 - a. Toggle the **Scramble** soft key between **Auto** and **Manual**.
 - b. Enter a value by using the numeric keys to set manually.
 - c. Press the **Enter** soft key.
 3. *Optional.* Press the **Detect Mode** soft key, and then select the signal standard option: **WCDMA, HSDPA, or HSPA+**. HSDPA is set by default.
 4. To set the S-CCPCH information of the system to be tested, complete the following steps:
 - a. Press the **S-CCPCH** soft key.
 - b. Toggle the **S-CCPCH** soft key between **On** and **Off** to enable or disable the S-CCPCH. Setting this on makes the S-CCPCH in the Alarm Code menu activated.
 - c. Press the **Spread Factor** soft key, and then select the spread factor option: **4, 8, 16, 32, 64, 128, or 256**.
 - d. Press the **Spread Code** soft key to set the spread code.
 - e. Enter a value by using the numeric keys.
-

- f. Press the **Enter** soft key.
5. To set the PICH information of the system to be tested, complete the following steps:
 - a. Press the **PICH** soft key.
 - b. Toggle the **PICH** soft key between **On** and **Off** to enable or disable the PICH. Setting this on makes the PICH in the Alarm Code menu activated.
 - c. Press the **Spread Factor** soft key, and then select the spread factor option: **4, 8, 16, 32, 64, 128, or 256**.
 - d. Press the **Spread Code** soft key to set the spread code.
 - e. Enter a value by using the numeric keys.
 - f. Press the **Enter** soft key.
6. *Optional.* To set the threshold, complete the following steps:
 - a. Press the **Threshold** soft key.
 - b. Enter a value by using the numeric keys.
 - c. Press the **Enter** soft key.
7. Press the **Alarm Code** soft key, and then select the alarm code option: **None, CPICH, P-CCPCH, S-CCPCH, PICH, P-SCH, or S-SCH**.

NOTE

The alarm codes S-CCPCH and PICH become activated in case that you have enabled the S-CCPCH and PICH respectively.

8. To set the alarm mask, complete the following steps:
 - a. Press the **Set Mask** soft key.
 - b. Enter a value by using the numeric keys.
 - c. Press the **Enter** soft key.
9. *Optional.* Go to **SAVE/LOAD > Save**, and then select the save option from the choices available for your measurement mode. See “Using save” on page 31 for more information.

Measurement example

Figure 59 RCSI measurement with WCDMA/HSPA+ signal analyzer



Setting display

You can view your measurement results in a different view option.

Procedure

1. Press the **TRACE/DISPLAY** hard key.
 2. Toggle the **View** soft key and select the display option:
 - **Zoom**: to view the result in detail with zoom-in window. The Position and Width menus become activated.
 - **Full**: to view the full measurement result.
 3. To define the zoom start position and width, complete the following steps:
 - a. Press the **Position** soft key.
 - b. Enter a value of the position by using the numeric keys.
 - c. Press the **Enter** soft key.
 - d. Press the **Width** soft key, and then select the Walsh code option: **32, 64, 128, or 256**.
-

CDP Table

The CDP Table is used to look at a numeric and textual description of all the active code channels in the signal.

Setting measure setup

After configuring test parameters as described in the “Configuring test parameters” on page 137, you can continue your measurement. The measurement settings can be saved and recalled as a file. You can also use JDViewer, PC application software to configure a measure setup, save as a file, and load the file on to the instrument.

Procedure

1. Press the **MEASURE SETUP** hot key.
 2. *Optional.* To set the scramble code, complete the following steps:
 - a. Toggle the **Scramble** soft key between **Auto** and **Manual**.
 - b. Enter a value by using the numeric keys to set manually.
 - c. Press the **Enter** soft key.
 3. *Optional.* Press the **Detect Mode** soft key, and then select the signal standard option: **WCDMA, HSDPA, or HSPA+**. HSDPA is set by default.
 4. To set the S-CCPCH information of the system to be tested, complete the following steps:
 - a. Press the **S-CCPCH** soft key.
 - b. Toggle the **S-CCPCH** soft key between **On** and **Off** to enable or disable the S-CCPCH.
 - c. Press the **Spread Factor** soft key, and then select the spread factor option: **4, 8, 16, 32, 64, 128, or 256**.
 - d. Press the **Spread Code** soft key to set the spread code.
 - e. Enter a value by using the numeric keys.
 - f. Press the **Enter** soft key.
 5. To set the PICH information of the system to be tested, complete the following steps:
-

- a. Press the **PICH** soft key.
 - b. Toggle the **PICH** soft key between **On** and **Off** to enable or disable the PICH.
 - c. Press the **Spread Factor** soft key, and then select the spread factor option: **4, 8, 16, 32, 64, 128, or 256**.
 - d. Press the **Spread Code** soft key to set the spread code.
 - e. Enter a value by using the numeric keys.
 - f. Press the **Enter** soft key.
6. *Optional.* To set the threshold, complete the following steps:
- a. Press the **Threshold** soft key.
 - b. Enter a value by using the numeric keys.
 - c. Press the **Enter** soft key.

Measurement example

Figure 60 CDP Table measurement with WCDMA/HSPA+ signal analyzer



Setting display

If the CDP table spans over to the next page(s), you can change pages up and down to view .your measurement results.

Procedure

1. Press the **TRACE/DISPLAY** hard key.
2. Select **Page Up** or **Page Down** as needed.

Setting limit for modulation tests

Procedure

1. Press the **LIMIT** hot key.

2. Press the **Modulation Test Limits** soft key to set the limits.
3. Select the test item(s) and set the limit(s) depending on your selected measurement mode:

To set the limit for	Select	Set
Frequency error	Frequency Error	High Limit Low Limit
Error vector magnitude	EVM	High Limit
Peak code domain error	PCDE	High Limit
Carrier feed through	Carrier Feed Through	High Limit
Correlated power in coded channel	CPICH	High Limit [Abs Rel] Low Limit [Abs Rel]
Highest level among inactive channels	Max Inactive	High Limit
Relative code domain error	RCDE	High Limit (QPSK) High Limit (16 QAM) High Limit (64 QAM)

4. *Optional.* You can enable alarm sound that goes off if the measurement falls outside of the limit. Toggle the **Beep** soft key between **On** and **Off** to enable or disable the beep sound.
5. *Optional.* Go to **SAVE/LOAD > Save**, and then select **Limit** to save the limit settings. See "Using save" on page 31 for more information.

NOTE

The Carrier Feed Through is a result of the RF carrier signal feeding through the I/Q modulator and riding on the output circuitry without being modulated.

Performing auto measurements

The Auto Measure function of the JD780A series allows a complete signal profiling covering RF characterization and modulation quality parameters of up to 10 different carriers, particularly useful on an overlay architecture where base stations are transmitting in different frequencies.

The Auto Measure can be easily executed either by selecting a menu in the instrument or by running a programmed scenario in the PC-based application so that the instrument automatically configure and perform tests on every aspect of all the carriers.

Setting limit for auto measure

You can set test limits for test item(s) in the auto measurement.

Procedure

1. Press the **LIMIT** hot key.
2. Press the **RF Test Limits** soft key, and then enable test limits as desired.
3. Press the **Modulation Test Limits** soft key, and then enable test limits as desired.
4. *Optional.* You can enable alarm sound that goes off if the measurement falls outside of the limit. Toggle the **Beep** soft key between **On** and **Off** to enable or disable the beep sound.
5. *Optional.* Go to **SAVE/LOAD > Save**, and then select **Limit** to save the limit settings. See "Using save" on page 31 for more information.

Setting measure setup

After configuring test parameters as described in the “Configuring test parameters” on page 137, you can continue your measurement. The measurement settings can be saved and recalled as a file. You can also use JDViewer, PC application software to configure a measure setup, save as a file, and load the file on to the instrument.

Procedure

1. Press the **MEASURE SETUP** hot key.
 2. Toggle the **Configuration** soft key and select the configuration option:
 - **Current**: to let the instrument use current frequency (single carrier) and determine pass or fail based on the instrument’s limit settings in Auto Measure.
 - **Scenario**: to run a test with a programmed scenario in JDViewer. The Scenario menu becomes activated.
 3. To load a scenario, press the **Scenario** soft key, and then select a scenario file to load.
 4. Toggle the **Test Time** soft key and select the test time option:
 - **Now**: to let the instrument run a test only once.
 - **Schedule**: to let the instrument repeat tests as defined in the Set Timing. The Set Timing menu becomes activated.
 5. To define a schedule for an auto measurement, complete the following steps:
 - a. Press the **Set Timing** soft key.
 - b. Press the **Start Time (HH:MM)** soft key.
 - c. Enter the time in the HH:MM format, and then press the **Enter** soft key.
 - d. Press the **Stop Time (HH:MM)** soft key.
 - e. Enter the time in the HH:MM format, and then press the **Enter** soft key.
 - f. Press the **Time Interval** soft key.
 - g. Enter the amount of time in minutes, and then press the **Enter** soft key.
 6. To set external offset, complete the following steps:
 - a. Toggle the **External Offset** soft key and select **On**.
 - b. Enter a value by using the numeric keys, and then press the **dB** soft key.
 6. To save your settings and results, go to **SAVE/LOAD > Save** and then perform functions as you desire. See “Using save” on page 31 for more information.
 7. Press the **Run Test** soft key to start to run a test. The Auto Measure Results window appears at the end of the test.
 8. To stop running the test, press the **Abort** soft key.
 9. To change the view on the screen during the test, press the **Display** and then select the view option from the following choices:
 - **Screen**: You can view each measurement screen as the test progresses.
 - **Results**: You can view a measurement result table as the test progresses.
 - **Settings**: You can view a measurement setting table as the test progresses.
-

Setting display

After completion of the auto measurement, the screen menu changes to Trace/Display so that you can

view the results in different forms.

Procedure

1. Toggle the **Display** soft key and select the display option:
 - **Result:** to view the result table.
The Display Result menu becomes activated.
 - **Settings:** to view the measurement settings for the auto measurement.
 2. Toggle the **Display Result** soft key and select the display result option:
 - **Full:** to view detailed measurement readings with the pass/fail indication.
 - **Quick:** to view only the Pass/Fail results.
 3. To view the measurement results for a different carrier, press the **View Carrier** soft key and then select the carrier number to view.
-

Performing power statistics CCDF measurement

The Power Statistics Complementary Cumulative Distribution Function (CCDF) measurement characterizes the power statistics of the input signal. It provides PAR (Peak to Average power Ratio) versus different probabilities.

Setting measure setup

After configuring test parameters as described in the “Configuring test parameters” on page 137, you can continue your measurement. The measurement settings can be saved and recalled as a file. You can also use JDViewer, PC application software to configure a measure setup, save as a file, and load the file on to the instrument.

Procedure

1. Press the **MEASURE SETUP** hot key.
 2. Press the **CCDF Length** soft key to set the length of the CCDF.
 3. Enter a value between 1 and 100 by using the numeric keys. You can also use the rotary knob.
 4. Press the **Enter** soft key.
-

Measurement example

Figure 61 CCDF measurement with WCDMA/HSPA+ signal analyzer



Conducting WCDMA/HSPA+ OTA measurements

This Over The Air (OTA) measurement has channel scanner, scramble scanner, multipath profile, code domain power, and route map screens. Scramble scanner displays six scrambling codes and powers to inform neighbor cells existence and its power. The multipath profile graph helps you to determine testing area's RF environmental condition. The code domain power shows not only modulation performance metric but also amplifier capacity and code utilization metric. The amplifier capacity (code utilization) measurement is an estimate of the amount of power amplifier capacity (code utilization) that is being used expressed in percent of maximum.

Channel scanner

Setting channel/frequency

Procedure

To set the channels to be scanned:

1. Press the **FREQ/DIST** hard key.
2. Toggle the **Unit** soft key and select **Channel**.
3. Press the **Index** soft key, and then enter an index number by turning the rotary knob or using the numeric keys.
4. To select the standard channel, complete the following steps:
 - a. Press the **Channel Std** soft key. The standard channel window appears. See "Appendix C – Band, frequency & channel standard" on page 541 for more information.
 - b. Select the band to be measured by using the rotary knob, the arrow keys, or the **Page Up/Page Down** soft keys.
 - c. Press the **Select** soft key or the rotary knob to confirm the selection.
5. To set the channel number for the selected index, complete the following steps:
 - a. Press the **Channel Number** soft key.

- b. Enter a value by using the numeric keys. You can also use the rotary knob.
- c. Press the **Enter** soft key.

The instrument displays a corresponding center frequency for the channel number.

6. To set the integration bandwidth for the selected index, complete the following steps:
 - a. Press the **Integration Bandwidth** soft key.
 - b. Enter a value by using the numeric keys. You can also use the rotary knob.
 - c. Select the unit: **GHz**, **MHz**, **kHz**, or **Hz**.
7. To add more channels to be scanned, repeat steps 3-6.
8. Press the **ESC** hard key to dismiss the channel list window and view the scanning result.

To set the frequencies to be scanned:

1. Press the **FREQ/DIST** hard key.
2. Toggle the **Unit** soft key and select **Freq**.
3. Press the **Index** soft key, and then enter an index number by turning the rotary knob or using the numeric keys.
4. To set the center frequency for the selected index, complete the following steps:
 - a. Press the **Center Frequency** soft key.
 - b. Enter a value by using the numeric keys. You can also use the rotary knob.
 - c. Select the unit: **GHz**, **MHz**, **kHz**, or **Hz**.
5. To set the integration bandwidth for the selected index, complete the following steps:
 - a. Press the **Integration Bandwidth** soft key.
 - b. Enter a value by using the numeric keys. You can also use the rotary knob.
 - c. Select the unit: **GHz**, **MHz**, **kHz**, or **Hz**.
6. To add more channels to be scanned, repeat steps 3-5.
7. Press the **ESC** hard key to dismiss the channel list window and view the scanning result.

Setting limit for OTA channel scanner

Procedure

1. Press the **LIMIT** hot key.
2. Press the **Limit Line** soft key to set a threshold for the limit line and Pass/Fail indication.
3. Enter a value, and then press the **dBm** unit soft key.
4. Toggle the **Limit Line** soft key between **On** and **Off** to display or dismiss the limit line.
5. *Optional.* You can enable alarm sound that goes off if the measurement falls outside of the limit. Toggle the **Beep** soft key between **On** and **Off** to enable or disable the beep sound.
6. *Optional.* Go to **SAVE/LOAD > Save**, and then select **Limit** to save the limit settings. See "Using save" on page 31 for more information.

Measurement example

Figure 62 Channel scanner measurement with WCDMA/HSPA+ OTA signal analyzer



Scramble scanner

The WCDMA/HSPA+ mobile receives signals from multiple base stations that all of these signals share the same spectrum and are present at the same time. Each base station has a unique scrambling code assigned to the particular base station and it differentiates its signal from other base stations in the area.

Measurement example

Figure 63 Scramble scanner measurement with WCDMA/HSPA+ OTA signal analyzer



Multipath profile

The Multipath Profile enables you to determine RF environmental conditions of testing area. It indicates the amount of power of the dominant pilot signal that is dispersed outside the main

correlation peak due to multipath echoes that are expressed in dB. This value should be very small ideally.

The multipath profile is the result of portions of the original broadcast signal arriving at the receiving antenna out of phase. This can be caused by the signal being reflected off objects such as buildings, or being refracted through the atmosphere differently from the main signal.

Measurement example

Figure 64 Multipath profile measurement with WCDMA/HSPA+ OTA signal analyzer



Code domain power

Channels with high correlation factors are determined to be active channels and are indicated as such on the display. Once the channels are decoded, the analyzer determines the power of each channel relative to the total signal power.

This measurement helps to verify that each code channel is operating at its proper level and helps to identify problems throughout the transmitter design from the coding to the RF section. System imperfections, such as the non-linearity of amplifiers, will present themselves as an undesired distribution of power in the code domain.

Setting measure setup

After configuring test parameters, you can set the measure setup to continue your measurement. The measurement settings can be saved and recalled as a file. You can also use JDViewer, PC application software to configure a measure setup, save as a file, and load the file on to the instrument.

Procedure

1. Press the **MEASURE SETUP** hot key.
2. To set the scramble code, complete the following steps:
 - a. Toggle the **Scramble** soft key between **Auto** and **Manual**.
 - b. Enter a value by using the numeric keys to set manually.

- c. Press the **Enter** soft key.
3. Press the **Detect Mode** soft key, and then select the signal standard option: **WCDMA**, **HSDPA**, or **HSPA+**. HSDPA is set by default.
4. To set the threshold, complete the following steps:
 - a. Press the **Threshold** soft key.
 - b. Enter a value by using the numeric keys.
 - c. Press the **Enter** soft key.
5. To set the S-CCPCH information of the system to be tested, complete the following steps:
 - a. Press the **S-CCPCH** soft key.
 - b. Toggle the **S-CCPCH** soft key between **On** and **Off** to enable or disable the S-CCPCH.
 - c. Press the **Spread Factor** soft key, and then select the spread factor option: **4**, **8**, **16**, **32**, **64**, **128**, or **256**.
 - d. Press the **Spread Code** soft key to set the spread code.
 - e. Enter a value by using the numeric keys.
 - f. Press the **Enter** soft key.
6. To set the PICH information of the system to be tested, complete the following steps:
 - a. Press the **PICH** soft key.
 - b. Toggle the **PICH** soft key between **On** and **Off** to enable or disable the PICH.
 - c. Press the **Spread Factor** soft key, and then select the spread factor option: **4**, **8**, **16**, **32**, **64**, **128**, or **256**.
 - d. Press the **Spread Code** soft key to set the spread code.
 - e. Enter a value by using the numeric keys.
 - f. Press the **Enter** soft key.
7. To set the maximum amplifier power, complete the following steps:
 - a. Press the **Max Amplifier Power** soft key.
 - b. Enter a value by using the numeric keys.
 - c. Press the **dBm** soft key.
8. To set the CPICH power, complete the following steps:
 - a. Press the **More (1/2)** soft key.
 - b. Press the **CPICH** soft key.
 - c. Enter a value by using the numeric keys.
 - d. Press the **dBm** soft key.
9. To set the threshold for CPICH dominance, complete the following steps:
 - a. Press the **CPICH Dominance >** soft key.
 - b. Enter a value by using the numeric keys.
 - c. Press the **Enter** soft key.

NOTE

Recommended value is 10. Color of the CPICH Dominance indicator on the screen bases on this setting.

10. To set the threshold for multipath power, complete the following steps:
 - a. Press the **Multipath Power <** soft key.
 - b. Enter a value by using the numeric keys.
 - c. Press the **Enter** soft key.

NOTE

Recommended value is one. Color of the multipath power indicator on the screen bases on this setting.

- Optional. Go to **SAVE/LOAD > Save**, and then select the save option from the choices available for your measurement mode. See “Using save” on page 31 for more information.

Measurement example

Figure 65 Code domain power measurement with WCDMA/HSPA+ OTA signal analyzer



NOTE

You can use the **LIMIT** hot key to analyze your measurements with the user-definable limit and Pass/Fail indication.

Route map

The JD780A Series provides indoor and outdoor mapping function that allows a user to collect data of points in an indoor or outdoor environment and track the received signals and coverage of RF transmitters plotting real time directly on top of a loaded floor plan or a map.

Setting measure setup

Procedure

- If required, connect a GPS receiver to your JD780A series for outdoor mapping. Indoor mapping does not necessarily need a GPS antenna.
- Configure test parameters as described in the “Configuring test parameters” on page 137.
- To load your map file, complete the following steps:
 - Plug in your USB drive that has a floor map or .mcf file type created in JDMapCreator.

NOTE

The JDMapCreator converts and resizes any scanned floor plan or layout to fit onto your instrument’s display. You must save your map files (.mcf) into the “**SavedMap**” folder of your USB drive so that you can load them onto your instrument.

- b. Press **SAVE/LOAD** hot key, and then select **Load > Load Map**. See "Using load" on page 34 for more information.
4. Press the **MEASURE SETUP** hot key.
5. Press the **Plot Point** soft key, and then select the plot point option from the following choices:
 - To collect data/plot points automatically as you move around in a vehicle or outside, press the **GPS** soft key and then toggle the **Screen Mode** soft key between **Map** and **Full**.

NOTE

With the **Map** setting, you can view only the collected points that can be seen within the boundary of the loaded map. If a point is off the map, the instrument displays an arrow to indicate the direction of the current location on the map and the distance from the center to the location at the top of the screen.

With the **Full** setting, you can view all the collected points of the route without the loaded map.

- To collect data/plot points manually without a GPS antenna in an indoor environment, press the **Position** soft key.
6. Press the **Plot Item** soft key, and then select the measurement option: **CPICH Power** or **Ec/Io**.
 7. Toggle the **Plot** soft key and select **Start**.
 8. Touch directly on the screen or press the **ENTER** hard key to collect data and plot points on the loaded map for the **Position** setting.

NOTE

For the **Position** setting, you can change the direction of the route with the arrow keys and the distance with the rotary knob.

9. Toggle the **Plot** soft key and select **Stop** to stop plotting.
10. Press the **SAVE/LOAD** hot key to save the result. See "Using save" on page 31 for more information.

NOTE

The instrument does not automatically save the collected data. It is recommended that you save the result. Otherwise, you will lose all the collected data.

Setting limit

You can set the thresholds for the four different color indicators for CPICH power or Ec/Io.

Procedure

1. Press the **LIMIT** hot key.
2. To set the limits for CPICH power if you have selected CPICH as for the plot item, complete the following steps:
 - a. Press the **CPICH Power** soft key.
 - b. Press the **Excellent** soft key to set its threshold.
 - c. Enter a value, and then press the **dBm** soft key. You can also use the rotary knob.
 - d. Press the **Very Good** soft key to set its threshold.
 - e. Enter a value, and then press the **dBm** soft key. You can also use the rotary knob.
 - f. Press the **Good** soft key to set its threshold.
 - g. Enter a value, and then press the **dBm** soft key. You can also use the rotary knob.
 - h. Press the **Fair** soft key to set its threshold.

- i. Enter a value, and then press the **dBm** soft key. You can also use the rotary knob.
 - j. Press the **Poor** soft key to set its threshold.
 - k. Enter a value, and then press the **dBm** soft key. You can also use the rotary knob.
3. To set the limits for Ec/Io if you have selected as for the plot item , complete the following steps:
- a. Press the **Ec/Io** soft key.
 - b. Press the **Good** soft key to set its threshold.
 - c. Enter a value, and then press the **Enter** soft key. You can also use the rotary knob.
 - d. Press the **Fair** soft key to set its threshold.
 - e. Enter a value, and then press the **Enter** soft key. You can also use the rotary knob.
 - f. Press the **Poor** soft key to set its threshold.
 - g. Enter a value, and then press the **Enter** soft key. You can also use the rotary knob.
4. *Optional.* Go to **SAVE/LOAD > Save**, and then select **Limit** to save the limit settings. See "Using save" on page 31 for more information.

Measurement example

Figure 66 Route map measurement with WCDMA/HSPA+ OTA signal analyzer

1) CPICH Power



2) CPICH Ec/Io



Using LTE - FDD Signal Analyzer

This chapter provides instructions for using the LTE - FDD Signal Analyzer (option 028) and LTE-Advanced FDD Analyzer (option 030) with the LTE - FDD OTA Analyzer (option 048). Topics discussed in this chapter are as follows:

■ Introduction	176
■ Display overview	177
■ Connecting a cable	177
■ Selecting measurement mode	179
■ Configuring test parameters	179
■ Conducting spectrum measurements	184
■ Conducting RF measurements	186
■ Conducting power vs. time (frame) measurements	194
■ Conducting modulation measurements	195
■ Performing auto measurements	214
■ Performing power statistics CCDF measurements	221
■ Performing carrier aggregation measurements	222
■ Conducting LTE - FDD OTA measurements	225

Introduction

The LTE (Long-Term Evolution) Signal Analyzer of the JD780A series performs power and spectrum measurements as well as modulation analysis to test the proper transmitter performance of FDD LTE systems. It performs conformance testing according to the following standards providing a simple Pass/Fail indication on each test.

- 3GPP TS 36.104. Evolved Universal Terrestrial Radio Access (E-UTRA); Base Station (BS) Radio Transmission and Reception
- 3GPP TS 36.141. Evolved Universal Terrestrial Radio Access (E-UTRA); Base Station (BS) Conformance Testing
- 3GPP TS 36.211. Evolved Universal Terrestrial Radio Access (E-UTRA); Physical Channels and Modulation
- 3GPP TS 36.212. Evolved Universal Terrestrial Radio Access (E-UTRA); Multiplexing and Channel Coding
- 3GPP TS 36.213 V8.2.0. Evolved Universal Terrestrial Radio Access (E-UTRA); Physical Layer Procedures

This instrument provides the following measurement tools for FDD LTE system:

- Spectrum Analysis
- RF Analysis
 - Channel Power
 - Occupied Bandwidth
 - Spectrum Emission Mask
 - Adjacent Channel Leakage power Ratio (ACLR)
 - Multi-ACLR
 - Spurious Emissions
- Power vs. Time (Frame)
- Modulation Analysis
 - Constellation
 - Data Channel
 - Control Channel
 - Subframe
 - Frame
 - Time Alignment Error
 - Data Allocation Map
- Auto Measure:
 - Conformance Test
 - Maintenance Test
 - Signal Performance Test
 - DAS Test

- Power Statistics CCDF
- Carrier Aggregation
- Over The Air (OTA)
 - Channel Scanner
 - ID Scanner
 - Multipath Profile
 - Control Channel
 - Datagram
 - Route Map

Display overview

Figure 67 provides descriptions for each segment of the measurement screen.

Figure 67 LTE - FDD signal analyzer measurement screen

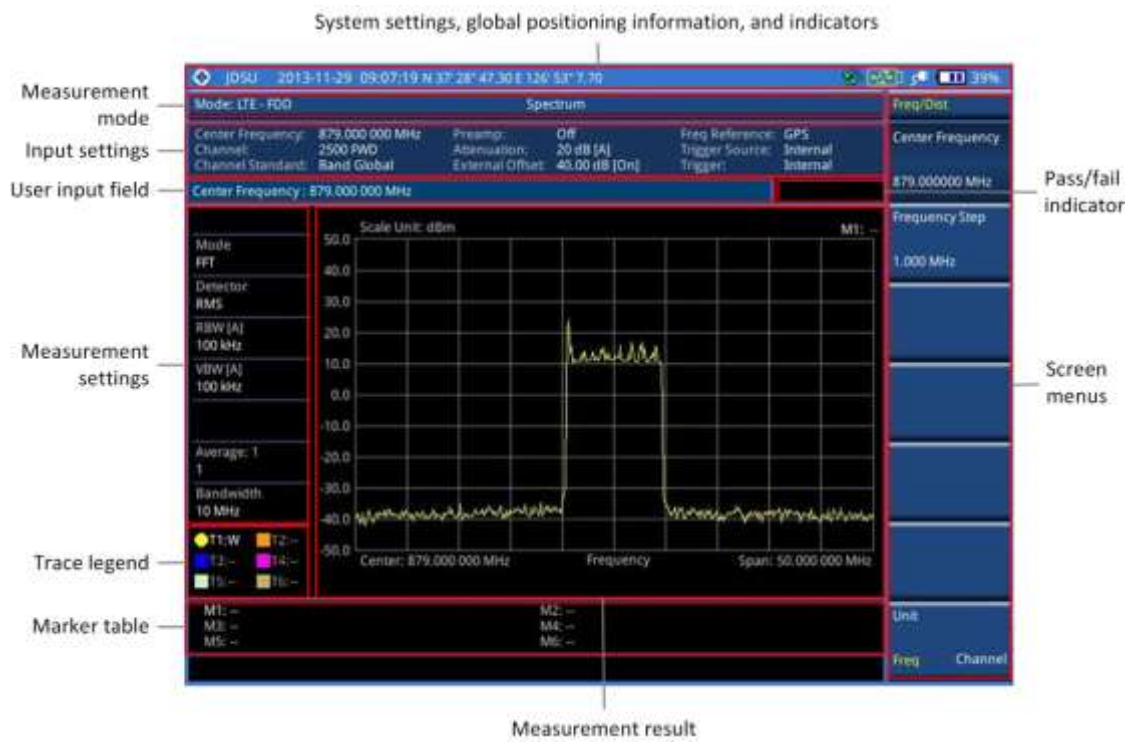

Connecting a cable

Direct connection

Procedure

1. Connect the **Spectrum Analyzer RF In** port of the JD780A series and the Power amplifier output port of BTS.

Figure 68 Direct connection

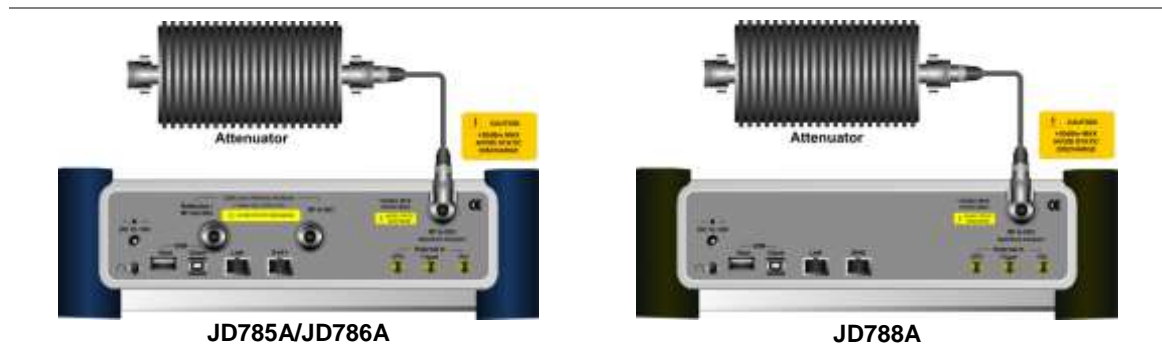

Indirect connection

Procedure

1. Connect the **Spectrum Analyzer RF In** port of the JD780A series and the monitor (test) port of BTS.

Figure 69 Indirect connection

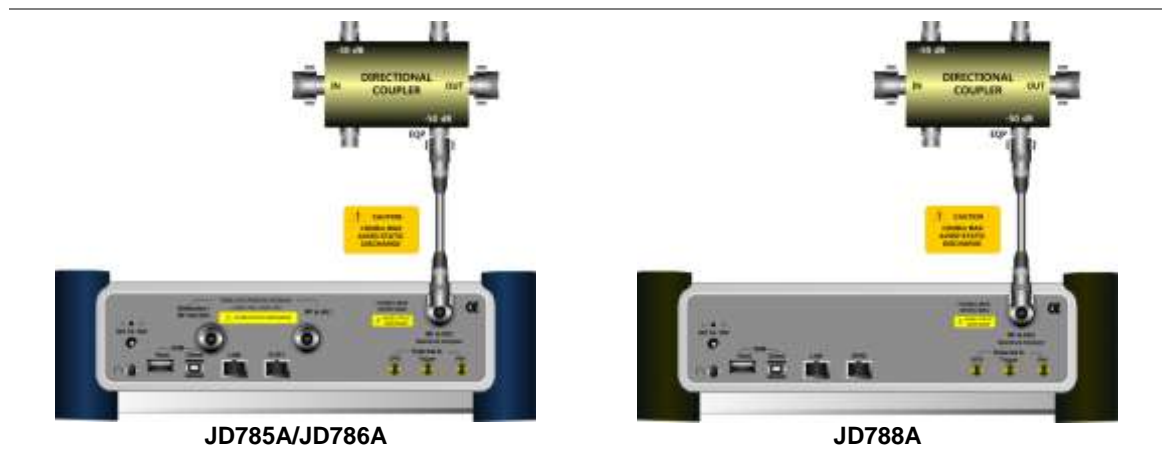

CAUTION

The maximum power for the **Spectrum Analyzer RF In** port is +25 dBm (0.316 W). If the input signal level to be measured is greater than +25 dBm, use a **High Power Attenuator** to prevent damage when you directly connect the signal to the instrument or connect the signal from the coupling port of a directional coupler.

Over the air (OTA)

Procedure

1. Connect an Omni/directional RF antenna to the **Spectrum Analyzer RF In** port of the JD780A series.
2. Connect a GPS antenna to the **GPS** port of the JD780A series.

Figure 70 OTA connection

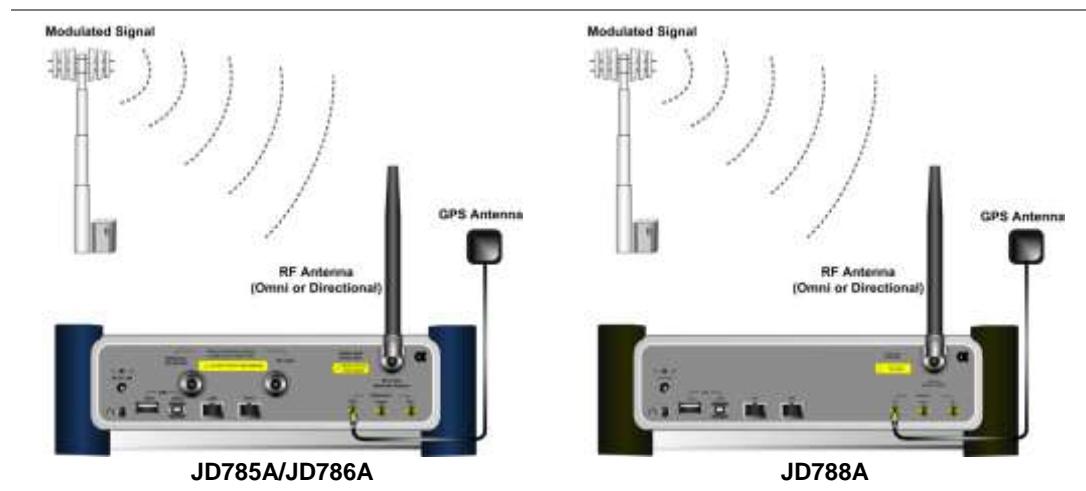
**CAUTION**

If the input signal level to be measured is less than 0 dBm, set 0 dB attenuation or turn on the preamp to have better dynamic range for the OTA testing.

Selecting measurement mode

Procedure

1. Press the **MODE** hard key.
2. Press the **Signal Analyzer** soft key.
3. Press the **LTE - FDD** soft key. The **Spectrum** mode is set by default.
4. Press the **MEASURE** hot key, and then select the measurement mode option from the following choices:
 - Spectrum
 - RF Analysis > Channel Power, Occupied BW, Spectrum Emission Mask, ACLR, Multi-ACLR, or Spurious Emissions
 - Power vs Time (Frame)
 - Modulation Analysis > Constellation, Data Channel, Control Channel, Subframe, Frame, Time Alignment Error, or Data Allocation Map
 - Auto Measure > Conformance Test, Maintenance Test, Signal Performance, or DAS Test
 - Power Statistics CCDF
 - More (1/2) > Carrier Aggregation
 - More (1/2) > OTA > Channel Scanner, ID Scanner, Multipath Profile, Control Channel, Datagram, or Route Map

NOTE

The **Carrier Aggregation** soft key is activated if the license for the option 030 LTE-Advanced FDD is installed.

Configuring test parameters

Setting frequency

You can set the frequency with either frequency or channel number. If a frequency to be set matches to the frequency corresponding to the selected channel standard, the instrument calculates its channel number and updates the screen with it automatically.

Procedure

To set the center frequency:

1. Press the **FREQ/DIST** hard key.
2. Toggle the **Unit** soft key and select **Freq**.
3. Press the **Center Frequency** soft key.
4. Enter a value by using the numeric keys. You can also use the rotary knob.
5. Select the unit: **GHz**, **MHz**, **kHz**, or **Hz**.
6. *Optional.* To define the amount of frequency increment for the rotary knob, complete the following steps:
 - a. Press the **Frequency Step** soft key.
 - b. Enter a value by using the numeric keys. You can also use the rotary knob.
 - c. Press the unit: **GHz**, **MHz**, **kHz**, or **Hz**.

To set the channel number:

1. Press the **FREQ/DIST** hard key.
2. Toggle the **Unit** soft key and select **Channel**.

NOTE

Selecting **Channel** sets the standard channel to **Band Global** automatically so that you can set the **Channel Number** without choosing a standard channel band from the list.

3. Press the **Channel Number** soft key.
4. Enter a value by using the numeric keys. You can also use the rotary knob.
5. Press the **Enter** soft key.

The instrument automatically displays the corresponding center frequency value for the selected channel number.

6. *Optional.* To define the amount of channel increment for the rotary knob, complete the following steps:
 - a. Press the **Channel Step** soft key.
 - b. Enter a value by using the numeric keys. You can also use the rotary knob.
 - c. Press the **Enter** soft key.

NOTE

This frequency setting is not used in the Multi-ACLR and Spurious Emissions modes.

Setting amplitude

Reference level and attenuation

You can set the reference and attenuation levels automatically or manually to optimize the display of the traces measured, as you desire.

Procedure

To automatically set the reference and attenuation level:

1. Press the **AMP/SCALE** hard key.
2. Press the **Auto Scale** soft key.
Each time you press this key, both of the Y-axis scale and input attenuation level change to be optimized with some margin.

To set the reference or attenuation level manually:

1. Press the **AMP/SCALE** hard key.
2. To set the maximum reference value on the Y-axis manually, complete the following steps:
 - a. Press the **Reference Level** soft key.
 - b. Enter a value by using the numeric keys or the rotary knob with 10 dB increments.
 - c. Press the **dBm** soft key or the **ENTER** hard key.

NOTE

In the measurements such as **Control Channel**, **Subframe**, and **Frame**, you may need to select the reference option between **Relative** and **Absolute** before setting the reference level.

3. To set the attenuation option, select one from the following choices:
 - To set the input attenuator's level automatically, select **Attenuation > Auto**.

NOTE

It is recommended that you set the **Attenuation** to **Auto** in most situations so that the level of the input attenuator can be set automatically according to your input signal level.

- To set the input attenuation manually up to 55 dB to optimize S/N, complete the following steps:
 - a. Select **Attenuation > Manual**.
 - b. Press the **Attenuation Value** soft key to set the level.
 - c. Enter a value between 0 and 55 in fives by using the numeric keys.
 - d. Press the **dB** soft key or the **ENTER** hard key.
- To couple the input attenuator's level with your reference level setting, select **Attenuation > Couple**. As you increase the reference setting, the attenuation level also increases accordingly.

Optional. To change the scale unit:

1. Select **More (1/2) > Units**.
2. Select the unit of the display scale: **dBm**, **dBV**, **dBmV**, **dBμV**, **V**, or **W**.
The scale unit on the screen changes accordingly.

NOTE

This Units menu is available in the Spectrum and RF Analysis modes.

Scale per division

You can use the **Scale/Div** feature available for the spectrum and RF analysis. It represents the value of one division on the horizontal scale. The default setting is 10 dB per division and the maximum value can be set up to 20 dB.

Procedure

To set the scale per division:

-
1. Press the **AMP/SCALE** hard key.
 2. Select **More (1/2) > Scale/Div**.
 3. Enter a value between 1 and 20 by using the numeric keys.
 4. Press the **dB** soft key to complete the entry.
-

Pre-amplifier

You can turn the internal pre-amplifier on to correct and compensate for the gain of the preamp so that amplitude readings show the value at the input connector.

Procedure

1. Press the **AMP/SCALE** hard key.
 2. Toggle the **Preamp** soft key and select **On** or **Off** as needed.
-

NOTE

You can turn the Preamp on when the input attenuation range is from 0 dB to 10 dB. If the attenuation value is manually set to greater than 10 dB, the instrument will automatically turn off the pre-amplifier to display low-level signal properly on the chart.

External offset

You can turn the **External Offset** on and manually set the external offset value. An offset consists of a cable loss and a user offset and the measurement result shows the value reflecting both offset values. When the external offset value is set at 40 dB in the Spectrum mode, the measurement result compensates 40 dB at both the Spectrum Analyzer and Signal Analyzer modes

Procedure

To set the external offset:

1. Press the **AMP/SCALE** hard key.
2. Toggle the **External Offset** soft key and select **On**.
3. Enter a value by using the numeric keys.
4. Press the **dB** soft key to complete the entry.

To turn the external offset off:

1. Press the **AMP/SCALE** hard key.
 2. Toggle the **External Offset** soft key and select **Off**.
-

Setting average

You can set the number of measurements to be averaged for the trace presentation. A maximum of 100 times of averaging can be set. When the averaging reaches to your setting, a new measurement value replaces the measurement value in sequence from the earliest.

Procedure

1. Press the **BW/AVG** hard key.
 2. Press the **Average** soft key.
-

3. Enter a value between 1 and 100 as needed by using the numeric keys.
4. Press the **Enter** soft key.

Setting sweep mode

The default settings of the sweep mode are **Continue** and **Normal** to sweep continuously at a normal speed for most on-going measurements. If you want to hold the measurement or get a single sweep, you can change the sweep mode.

Procedure

To select the single sweep mode:

1. Press the **SWEEP** hot key.
2. Toggle the **Sweep Mode** soft key and select **Single**. You can also use the **HOLD** hot key. The letter **HOLD** in red appears and the sweeping is paused.
3. *Optional.* Press the **Sweep Once** soft key to get a new measurement.

To return to the continuous sweep mode:

1. Toggle the **Sweep Mode** soft key and select **Continue**. You can also use the **HOLD** hot key. The letter **HOLD** in red disappears and the sweeping resumes.

Setting trigger source

You can set the trigger source option for your measurements.

Procedure

1. Press the **TRIGGER** hot key.
2. Select the trigger source option from the following choices: **Internal**, **External**, or **GPS**.

Setting external clock

To enhance the reliability of modulation analysis measurements the JD780A series must be synchronized with a base station. When an external clock is not supplied, the instrument works with its built-in internal high-accuracy time base and some measurement results may exhibit inaccurate values. Therefore, it is highly recommended that you use the same reference clock as the signal source. You can use the **TRIGGER** hot key to set the external clock.







Figure 71 Connection ports for external reference clock



Procedure

1. Connect an external reference or a GPS antenna to the JD780A series.
2. Press the **SYSTEM** hot key.
3. Press the **Freq Reference** soft key, and then select the reference option: **Internal**, **External 10 MHz**, **External 13 MHz**, **External 15 MHz**, or **GPS**.

Table 14 External reference indicators

Type	Indicator	Description
Internal	 (green)	The green INT icon indicates that the instrument uses the built-in internal time base.
External	 (green)	The green EXT icon indicates that an external reference is connected and locked and that the instrument uses the same reference clock as the signal source.
External	 (red)	The red EXT icon indicates that an external reference is connect but not locked.
GPS	 (green)	The green GPS antenna icon indicates that a GPS antenna is connected and locked.
GPS	 (yellow)	The yellow GPS antenna icon indicates that a GPS antenna is connected and locking is in progress.
GPS	 (grey)	The grey GPS antenna icon indicates that a GPS antenna is not connected, failed, or unable to be locked.

Conducting spectrum measurements

Setting measure setup

After configuring test parameters as described in the “Configuring test parameters” on page 179, you can continue your measurement.

Procedure

1. Press the **MEASURE SETUP** hot key.
2. Press the **Bandwidth** soft key.
3. Select the nominal channel bandwidth to be measured, from the following choices:
 - **1.4 MHz, 3 MHz, 5 MHz, 10 MHz, 15 MHz, and 20 MHz**

Your measurement result is displayed on the screen as like the following example, Figure 72.

Figure 72 Spectrum measurement screen with LTE - FDD signal analyzer



Setting trace

You can display up to six traces on the measurement chart simultaneously.

Procedure

1. Press the **TRACE/DISPLAY** hard key.
2. Press the **Select Trace** soft key, and then select the trace number: **T1**, **T2**, **T3**, **T4**, **T5**, or **T6**. The legend shape of the selected trace changes from square to round to indicate that the trace is the active one now.
3. Toggle the **Trace View** soft key and select **On**.
4. To clear, write or capture, or hide the trace(s), do one of the following:

To	Select	Trace Legend
Clear current data and display with new measurements	Clear Write	W
Display the input signal's maximum response only	Max Hold	M
Display the input signal's minimum response only	Min Hold	m
Capture the selected trace and compare traces	Capture	C
Load a saved trace	More (1/2) > Load	L
Hide the selected trace	Trace View > Off	F
Remove all the traces and initialize the trace settings	More (1/2) > Trace Clear All	

5. *Optional.* Press the **More (1/2) > Trace Info** soft key, and then select the trace number to view the trace's parameter setting information stored at the time of the measurement or **None** to hide the information display.
6. *Optional.* If you have the two traces T1 and T2, you can perform trace math. To view the power difference between the traces, press the **T1 – T2 -> T5** or **T2 – T1 -> T6** soft key. The result is overlaid on the screen along with the second Y-axis.

Conducting RF measurements

Channel power

The Channel Power measurement is a common test used in the wireless industry to measure the total transmitted power of a radio within a defined frequency channel. It acquires a number of points representing the input signal in the time domain, transforms this information into the frequency domain using Fast Fourier Transform (FFT), and then calculates the channel power. The effective resolution bandwidth of the frequency domain trace is proportional to the number of points acquired for the FFT.

The channel power measurement identifies the total RF power and power spectral density (PSD) of the signal in the LTE channel bandwidth.

Setting measure setup

After configuring test parameters as described in the “Configuring test parameters” on page 179, you can continue your measurement.

Procedure

1. Press the **MEASURE SETUP** hot key.
2. Press the **Bandwidth** soft key.
3. Select the nominal channel bandwidth to be measured, from the following choices:
 - 1.4 MHz, 3 MHz, 5 MHz, 10 MHz, 15 MHz, and 20 MHz

Measurement example

Figure 73 Channel power measurement with LTE - FDD signal analyzer



NOTE

You can use the **LIMIT** hot key to analyze your measurements with the user-definable limit and Pass/Fail indication. See “Setting limit for RF tests” on page 193 for more information.

Occupied bandwidth

The Occupied Bandwidth measures the spectrum shape of the carrier. It is defined as the bandwidth, which includes 99% of the transmitted power among total transmitted power.

Setting measure setup

After configuring test parameters as described in the “Configuring test parameters” on page 179, you can continue your measurement.

Procedure

1. Press the **MEASURE SETUP** hot key.
 2. Press the **Bandwidth** soft key.
 3. Select the nominal channel bandwidth to be measured, from the following choices:
 - 1.4 MHz, 3 MHz, 5 MHz, 10 MHz, 15 MHz, and 20 MHz
-

Measurement example

Figure 74 Occupied bandwidth measurement with LTE - FDD signal analyzer

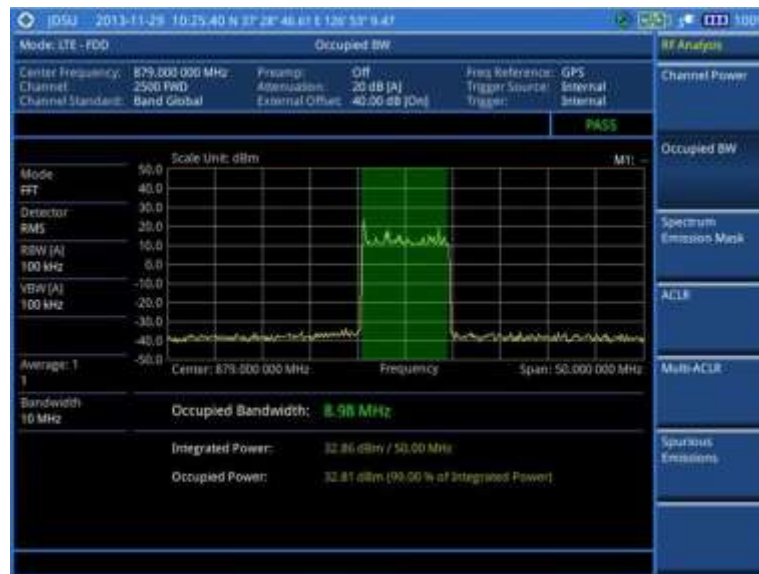

NOTE

You can use the **LIMIT** hot key to analyze your measurements with the user-definable limit and Pass/Fail indication. See “Setting limit for RF tests” on page 193 for more information.

Spectrum emission mask (SEM)

The Spectrum Emission Mask (SEM) measurement required by 3GPP specifications encompasses different power limits and different measurement bandwidths (resolution bandwidths) at various frequency offsets. It may be expressed as a ratio of power spectral densities between the carrier and the specified offset frequency band. It provides useful figures-of-merit for the spectral re-growth and emissions produced by components and circuit blocks, without the rigor of performing a full SEM measurement.

The SEM measures spurious signal levels in up to five pairs of offset or region frequencies and relates them to the carrier power.

Setting measure setup

After configuring test parameters as described in the “Configuring test parameters” on page 179, you can continue your measurement.

Procedure

1. Press the **MEASURE SETUP** hot key.
2. To set the nominal channel bandwidth to be measured, complete the following steps:
 - a. Press the **Bandwidth** soft key.
 - b. Select the bandwidth option: **1.4 MHz, 3 MHz, 5 MHz, 10 MHz, 15 MHz, or 20 MHz.**
3. To select the mask type, complete the following steps:
 - a. Press the **Mask Type** soft key.
 - b. Select the mask type option, from the following choices:
 - **Wide Area BS Category A**
 - **Wide Area BS Category B**
 - **Local Area BS**
 - **Home BS**

Measurement example

Figure 75 SEM measurement with LTE - FDD signal analyzer



NOTE
 You can use the **LIMIT** hot key to analyze your measurements with the user-definable limit and Pass/Fail indication. See “Setting limit for RF tests” on page 193 for more information.

ACLR

The Adjacent Channel Leakage power Ratio (ACLR) measures the amount of interference or power in an adjacent frequency channel according to the standards.

Setting measure setup

After configuring test parameters as described in the “Configuring test parameters” on page 179, you can continue your measurement.

Procedure

1. Press the **MEASURE SETUP** hot key.
 2. Press the **Bandwidth** soft key.
 3. Select the nominal channel bandwidth to be measured, from the following choices:
 - 1.4 MHz, 3 MHz, 5 MHz, 10 MHz, 15 MHz, and 20 MHz
-

Measurement example

Figure 76 ACLR measurement with LTE - FDD signal analyzer



NOTE

You can use the **LIMIT** hot key to analyze your measurements with the user-definable limit and Pass/Fail indication. See “Setting limit for RF tests” on page 193 for more information.

Multi-ACLR

The Multi-ACLR measurement is used to perform multi-channel ACLR measurements with as many channels as possible. It helps you to measure ACLR in multi-channel transmitting Base Station environment.

Setting measure setup

After configuring test parameters as described in the “Configuring test parameters” on page 179, you

can continue your measurement.

Procedure

1. Press the **MEASURE SETUP** hot key.
2. To set the nominal channel bandwidth to be measured, complete the following steps:
 - a. Press the **Bandwidth** soft key.
 - b. Select the bandwidth option: **1.4 MHz, 3 MHz, 5 MHz, 10 MHz, 15 MHz, or 20 MHz**.
3. To set the frequency, do one of the following:
 - To set the center frequency, complete the following steps:
 - a. Toggle the **Unit** soft key and select **Freq**.
 - b. Press the **Lowest Frequency** soft key to set the starting center frequency.
 - c. Enter a value by using the numeric keys. You can also use the rotary knob.
 - d. Select the unit: **GHz, MHz, kHz, or Hz**.
 - e. Press the **Highest Frequency** soft key to set the stopping center frequency.
 - f. Enter a value by using the numeric keys. You can also use the rotary knob.
 - g. Select the unit: **GHz, MHz, kHz, or Hz**.
 - To set the channel number, complete the following steps:
 - a. Toggle the **Unit** soft key and select **Channel**.

NOTE

Selecting **Channel** sets the standard channel to **Band Global** automatically so that you can set the **Channel Number** without choosing a standard channel band from the list.

- b. Press the **Lowest Channel** soft key to set the starting channel.
 - c. Enter a value by using the numeric keys. You can also use the rotary knob.
 - d. Press the **Enter** soft key.
 - e. Press the **Highest Channel** soft key to set the stopping channel.
 - f. Enter a value by using the numeric keys. You can also use the rotary knob.
 - g. Press the **Enter** soft key.
-

Measurement example

Figure 77 Multi-ACLR measurement with LTE - FDD signal analyzer



NOTE

You can use the **LIMIT** hot key to analyze your measurements with the user-definable limit and Pass/Fail indication. See “Setting limit for RF tests” on page 193 for more information.

Spurious emissions

Out-of-band emissions are unwanted emissions immediately outside the channel bandwidth resulting from the modulation process and non-linearity in the transmitter but excluding spurious emissions. The Spurious Emissions measurement is to identify and determine the power level of out-of-band spurious emission within the necessary channel bandwidth and modulated signal measured at the RF port of the Base Station.

Setting measure setup

After configuring test parameters as described in the “Configuring test parameters” on page 179, you can continue your measurement.

Procedure

1. Press the **MEASURE SETUP** hot key.
2. To set up the range table and frequency range, press the **Range Table** soft key and then complete the following steps:
 - a. Press the **Range** soft key, and then enter the range number to add a new range or change an existing one.
 - b. Press the **Enter** soft key.
 - c. Press the **Start Frequency** soft key to set up the frequency range.
 - d. Enter a value by using the numeric keys. You can also use the rotary knob.
 - e. Select the unit: **GHz**, **MHz**, **kHz**, or **Hz**.
 - f. Press the **Stop Frequency** soft key to set up the frequency range.

- g. Enter a value by using the numeric keys. You can also use the rotary knob.
 - h. Select the unit: **GHz**, **MHz**, **kHz**, or **Hz**.
3. Toggle the **Range** soft key between **On** and **Off** to display or hide the selected range.
 4. To set up the test limits for Pass/Fail indication, complete the following steps:
 - a. Press the **Start Limit** soft key.
 - b. Enter a value by using the numeric keys. You can also use the rotary knob.
 - c. Select the **dBm** soft key.
 - d. Press the **Stop Limit** soft key.
 - e. Enter a value by using the numeric keys. You can also use the rotary knob.
 - f. Select the **dBm** soft key.
 5. To set up the other parameters, complete the following steps:
 - a. Select **More (1/2) > Attenuation** to set up the attenuation value.
 - b. Enter a value in the multiple of five.
 - c. Press the **dB** soft key or the **ENTER** hard key.
 - d. Press the **RBW** soft key.
 - e. Enter a value by using the numeric keys.
 - f. Select the unit: **GHz**, **MHz**, **kHz**, or **Hz**.
 - g. Press the **VBW** soft key.
 - h. Enter a value by using the numeric keys.
 - i. Select the unit: **GHz**, **MHz**, **kHz**, or **Hz**.
 6. Press the **PREV** hard key.
 7. Toggle the **Measure Type** soft key between **Examine** and **Full** to select the measurement type.

NOTE

The **Examine** mode displays only the selected range while the **Full** mode lets the instrument automatically changes the selected range from one another.

8. Set the number of measurements to be averaged:
 - a. Press the **Average** soft key.
 - b. Enter a value between 1 and 100.
 - c. Press the **Enter** soft key.
-

Measurement example

Figure 78 Spurious emissions measurement with LTE - FDD signal analyzer



NOTE

You can use the **LIMIT** hot key to analyze your measurements with the user-definable limit and Pass/Fail indication. See “Setting limit for RF tests” on page 193 for more information.

Setting limit for RF tests

By default, test limits specified in the standard are set for you. You can change thresholds if you desire.

Procedure

1. Press the **LIMIT** hot key.
2. Press the **RF Test Limits** soft key.
3. Select the test item(s) and set the limit(s) depending on your selected measurement mode:

To set the limit for	Select	Set
Channel power	Channel Power	High Limit Low Limit
Occupied bandwidth	Occupied BW	High Limit
Spectrum emission mask	Spectrum Emission Mask	(On/Off only)
ACLR	ACLR	(On/Off only)
Multi-ACLR	Multi-ACLR	(On/Off only)
Spurious emissions	Spurious Emissions	(On/Off only)

4. *Optional.* You can enable alarm sound that goes off if the measurement falls outside of the limit. Toggle the **Beep** soft key between **On** and **Off** to enable or disable the beep sound.
5. *Optional.* Go to **SAVE/LOAD > Save**, and then select **Limit** to save the limit settings. See “Using save” on page 31 for more information.

Conducting power vs. time (frame) measurements

The Power vs. Time (Frame) measures the modulation envelope in the time domain, showing the power of each time slot in an LTE signal.

Setting measure setup

After configuring test parameters as described in the “Configuring test parameters” on page 179, you can continue your measurement. The measurement settings can be saved and recalled as a file.

Procedure

1. Press the **MEASURE SETUP** hot key.
 2. To set the nominal channel bandwidth to be measured, complete the following steps:
 - a. Press the **Bandwidth** soft key.
 - b. Select the bandwidth option: **1.4 MHz, 3 MHz, 5 MHz, 10 MHz, 15 MHz, or 20 MHz**.
 3. To select the subframe number to be measured, complete the following steps:
 - a. Press the **Subframe No** soft key.
 - b. Enter a value by using the numeric keys. You can also use the rotary knob.
 - c. Press the **Enter** soft key.
 4. Toggle the **Cell ID** soft key and select **Auto** or **Manual** as desired:
 - **Auto**: to let the instrument detect the Cell ID for the LTE signal automatically.
 - **Manual**: to set a specific Cell ID for the LTE signal manually in order to speed up the synchronization with a BTS.
 5. *Optional.* Press the **Miscellaneous** soft key, and then do the following(s) as needed:
 - To select the number of antenna ports, toggle the **MIMO** soft key and select **2x2** or **4x4**. This MIMO (Multiple Input Multiple Output) setting is activated only if the option 030 LTE-Advanced FDD is installed with a license number. If not, the instrument sets this option to 2x2 by default. A 2x1 or 4x1 RF combiner is also required to be able to test on MIMO channels.
 - To assign a antenna port number automatically or manually, press the **Antenna Port** soft key and select the option: **Auto, 0, 1, 2, and 3**. If the option 030 LTE-Advanced FDD is not installed or if the MIMO is set to 2x2, the antenna ports 2 and 3 are disabled.
 - To select the cyclic prefix, toggle the **Cyclic Prefix** soft key and select **Normal** or **Extended**. See “Appendix E – Cyclic prefix table” on page 545 for OFDM parameter details by different bandwidth.
-

Measurement example

Figure 79 Power vs. time (frame) measurement with LTE – FDD signal analyzer



Conducting modulation measurements

Constellation

The Constellation is used to observe some aspects of modulation accuracy and can reveal certain fault mechanisms such as I/Q amplitude imbalance or quadrature imbalance. It displays constellation diagram by modulation types.

Setting measure setup

After configuring test parameters as described in the “Configuring test parameters” on page 179, you can continue your measurement. The measurement settings can be saved and recalled as a file.

Procedure

1. Press the **MEASURE SETUP** hot key.
2. To set the nominal channel bandwidth to be measured, complete the following steps:
 - a. Press the **Bandwidth** soft key.
 - b. Select the bandwidth option: **1.4 MHz**, **3 MHz**, **5 MHz**, **10 MHz**, **15 MHz**, or **20 MHz**.
3. To select the subframe number to be measured, complete the following steps:
 - a. Press the **Subframe No** soft key.
 - b. Enter a value by using the numeric keys. You can also use the rotary knob.

NOTE

For MBMS testing, this subframe number must be neither 0 nor 5 as these subframes 0 and 5 are not available for MBMS and it must be set to the MBMS transmitted channel's subframe number.

- c. Press the **Enter** soft key.
4. *Optional.* Toggle the **Cell ID** soft key and select **Auto** or **Manual** as desired:

- **Auto**: to let the instrument detect the Cell ID for the LTE signal automatically.
 - **Manual**: to set a specific Cell ID for the LTE signal manually in order to speed up the synchronization with a BTS.
5. *Optional*. Toggle the **CFI** soft key and select **Auto** or **Manual** as desired:
- **Auto**: to let the instrument set the number of OFDM symbols used for transmitting PDCCHs in a subframe.
 - **Manual**: to set the number of OFDM symbols manually. The set of OFDM symbols that can be used for PDCCH in a subframe is given by **0, 2, 3** or **4** in 1.4 MHz bandwidth and **1, 2**, or **3** in other bandwidths.
6. *Optional*. Press the **PHICH Ng** soft key, and then select the option for the number of PHICH groups (Ng): **1/6, 1/2, 1, 2, E-1/6, E-1/2, E-1**, or **E-2**.
7. *Optional*. Press the **Miscellaneous** soft key, and then do the following(s) as needed:
- To select the number of antenna ports, toggle the **MIMO** soft key and select **2x2** or **4x4**. This MIMO (Multiple Input Multiple Output) setting is activated only if the option 030 LTE-Advanced FDD is installed with a license number. If not, the instrument sets this option to 2x2 by default. A 2x1 or 4x1 RF combiner is also required to able to test on MIMO channels.
 - To assign a antenna port number automatically or manually, press the **Antenna Port** soft key and select the option: **Auto, 0, 1, 2**, and **3**. If the option 030 LTE-Advanced FDD is not installed or if the MIMO is set to 2x2, the antenna ports 2 and 3 are disabled.
 - To turn the Multimedia Broadcast Multicast Service (MBMS) feature on or off, toggle the **MBMS** soft key and select **On** or **Off**. For proper MBMS testing, you need to set the **Subframe No** with the same PMCH subframe number. If this setting is on, either PMCH or PDSCH appears on the screen depending on the detected channel.
 - To set the Multicast Broadcast Single Frequency Network (MBSFN) detection automatically or manually for MBMS testing, toggle the **MBSFN** soft key and select **Auto** or **Manual**. An automatically detected or manually entered MBSFN ID appears on the screen.
 - To select the cyclic prefix, toggle the **Cyclic Prefix** soft key and select **Normal** or **Extended**. See “Appendix E – Cyclic prefix table” on page 545 for OFDM parameter details by different bandwidth.
 - Press the **PDSCH Modulation Type** soft key, and then select the modulation type option: **Auto, QPSK, 16 QAM, 64 QAM, E-TM3.3, E-TM3.2, E-TM3.1, E-TM2, E-TM1.2**, and **E-TM1.1**. If two or more modulation types are used in a frame, select **Auto**. If the PDSCH uses the same modulation type in a frame or in a subframe, select a specific modulation type to get more accurate EVM.
 - To set the threshold for PDSCH, complete the following steps:
 - a. Press the **PDSCH Threshold** soft key.
 - b. Enter a value by using the numeric keys.
 - c. Press the **dB** soft key.
 - Toggle the **PDSCH Precoding** soft key between **On** and **Off** to enable or disable the PDSCH precoding.
-

Measurement example

Figure 80 Constellation measurement with LTE - FDD signal analyzer



Figure 81 Constellation measurement with LTE - FDD signal analyzer (MBMS On)



NOTE

You can use the **LIMIT** hot key to analyze your measurements with the user-definable limit and Pass/Fail indication. See “Setting limit for modulation tests” on page 213 for more information.

Data channel

The Data Channel measures the constellation for the specified resource block as well as the modulation accuracy of each PDSCH at the specified subframe.

Setting measure setup

After configuring test parameters as described in the “Configuring test parameters” on page 179, you

can continue your measurement. The measurement settings can be saved and recalled as a file.

Procedure

1. Press the **MEASURE SETUP** hot key.
2. To set the nominal channel bandwidth to be measured, complete the following steps:
 - a. Press the **Bandwidth** soft key.
 - b. Select the bandwidth option: **1.4 MHz, 3 MHz, 5 MHz, 10 MHz, 15 MHz, or 20 MHz**.
3. To select the subframe number to be measured, complete the following steps:
 - a. Press the **Subframe No** soft key.
 - b. Enter a value by using the numeric keys. You can also use the rotary knob.

NOTE

For MBMS testing, this subframe number must be neither 0 nor 5 as these subframes 0 and 5 are not available for MBMS and it must be set to the MBMS transmitted channel's subframe number.

- c. Press the **Enter** soft key.
 4. *Optional.* Toggle the **Cell ID** soft key and select **Auto** or **Manual** as desired:
 - **Auto:** to let the instrument detect the Cell ID for the LTE signal automatically.
 - **Manual:** to set a specific Cell ID for the LTE signal manually in order to speed up the synchronization with a BTS.
 5. *Optional.* Toggle the **CFI** soft key and select **Auto** or **Manual** as desired:
 - **Auto:** to let the instrument set the number of OFDM symbols used for transmitting PDCCHs in a subframe.
 - **Manual:** to set the number of OFDM symbols manually. The set of OFDM symbols that can be used for PDCCH in a subframe is given by **0, 2, 3 or 4** in 1.4 MHz bandwidth and **1, 2, or 3** in other bandwidths.
 6. *Optional.* Press the **PHICH Ng** soft key, and then select the option for the number of PHICH groups (Ng): **1/6, 1/2, 1, 2, E-1/6, E-1/2, E-1, or E-2**.
 7. Toggle the **Event Hold** soft key between **On** and **Off** to enable or disable the event hold feature. When enabled, the display line for the PDSCH threshold appears. When an event occurs, the measurement is put on hold until you press the **HOLD** hot key.
 8. *Optional.* Press the **Miscellaneous** soft key, and then do the following(s) as needed:
 - To select the number of antenna ports, toggle the **MIMO** soft key and select **2x2** or **4x4**. This MIMO (Multiple Input Multiple Output) setting is activated only if the option 030 LTE-Advanced FDD is installed with a license number. If not, the instrument sets this option to 2x2 by default. A 2x1 or 4x1 RF combiner is also required to be able to test on MIMO channels.
 - To assign a antenna port number automatically or manually, press the **Antenna Port** soft key and select the option: **Auto, 0, 1, 2, and 3**. If the option 030 LTE-Advanced FDD is not installed or if the MIMO is set to 2x2, the antenna ports 2 and 3 are disabled.
 - To turn the Multimedia Broadcast Multicast Service (MBMS) feature on or off, toggle the **MBMS** soft key and select **On** or **Off**. For proper MBMS testing, you need to set the **Subframe No** with the same PMCH subframe number. If this setting is on, either PMCH or PDSCH appears on the screen depending on the detected channel.
 - To set the Multicast Broadcast Single Frequency Network (MBSFN) detection automatically or manually for MBMS testing, toggle the **MBSFN** soft key and select **Auto** or **Manual**. An automatically detected or manually entered MBSFN ID appears on the screen.
 - To select the cyclic prefix, toggle the **Cyclic Prefix** soft key and select **Normal** or **Extended**. See "Appendix E – Cyclic prefix table" on page 545 for OFDM parameter details by different bandwidth.
-

- Press the **PDSCH Modulation Type** soft key, and then select the modulation type option: **Auto**, **QPSK**, **16 QAM**, **64 QAM**, **E-TM3.3**, **E-TM3.2**, **E-TM3.1**, **E-TM2**, **E-TM1.2**, and **E-TM1.1**. If two or more modulation types are used in a frame, select **Auto**. If the PDSCH uses the same modulation type in a frame or in a subframe, select a specific modulation type to get more accurate EVM.
- To set the threshold for PDSCH, complete the following steps:
 - a. Press the **PDSCH Threshold** soft key.
 - a. Enter a value by using the numeric keys, and then press the **dB** soft key.
- Toggle the **PDSCH Precoding** soft key between **On** and **Off** to enable or disable the PDSCH precoding.

Measurement example

Figure 82 Data channel measurement with LTE - FDD signal analyzer



Figure 83 Data channel measurement with LTE - FDD signal analyzer (MBMS On)



NOTE

You can use the **LIMIT** hot key to analyze your measurements with the user-definable limit and Pass/Fail indication. See “Setting limit for modulation tests” on page 213 for more information.

Using marker

You can use the **MARKER** hard key to place a marker on a resource block and display the IQ diagram for the selected resource block.

Procedure

1. Press the **MARKER** hard key.
2. Press the **RB Number** soft key to select the resource block to be marked.
3. Enter the resource block number by using the numeric keys.
4. Press the **Enter** soft key.
The marker appears on the selected resource block.
5. Toggle the **Marker View** soft key between **On** and **Off** to display or dismiss the result of the selected resource block.

Control channel

The Control Channel measures the constellation for the specified control channel as well as modulation accuracy of the control channel at the specified subframe.

Setting measure setup

After configuring test parameters as described in the “Configuring test parameters” on page 179, you can continue your measurement. The measurement settings can be saved and recalled as a file.

Procedure

1. Press the **MEASURE SETUP** hot key.
2. To set the nominal channel bandwidth to be measured, complete the following steps:
 - a. Press the **Bandwidth** soft key.
 - b. Select the bandwidth option: **1.4 MHz**, **3 MHz**, **5 MHz**, **10 MHz**, **15 MHz**, or **20 MHz**.
3. To select the subframe number to be measured, complete the following steps:
 - a. Press the **Subframe No** soft key.
 - b. Enter a value by using the numeric keys. You can also use the rotary knob.

NOTE

For MBMS testing, this subframe number must be neither 0 nor 5 as these subframes 0 and 5 are not available for MBMS and it must be set to the MBMS transmitted channel's subframe number.

- c. Press the **Enter** soft key.
4. *Optional.* Toggle the **Cell ID** soft key and select **Auto** or **Manual** as desired:
 - **Auto:** to let the instrument detect the Cell ID for the LTE signal automatically.
 - **Manual:** to set a specific Cell ID for the LTE signal manually in order to speed up the synchronization with a BTS.

-
5. *Optional.* Toggle the **CFI** soft key and select **Auto** or **Manual** as desired:
 - **Auto:** to let the instrument set the number of OFDM symbols used for transmitting PDCCHs in a subframe.
 - **Manual:** to set the number of OFDM symbols manually. The set of OFDM symbols that can be used for PDCCH in a subframe is given by **0, 2, 3** or **4** in 1.4 MHz bandwidth and **1, 2**, or **3** in other bandwidths.
 6. *Optional.* Press the **PHICH Ng** soft key, and then select the option for the number of PHICH groups (Ng): **1/6, 1/2, 1, 2, E-1/6, E-1/2, E-1**, or **E-2**.
 7. Toggle the **EVM Detection Mode** soft key and select **Single** or **Combine** as desired:
 - **Single:** Testing on one single antenna connected to your JD780A series with a cable.
 - **Combine:** Testing on multiple antennas connected to your JD780A series with a 2x1 or 4x1 combiner or an antenna.
 8. *Optional.* Press the **Miscellaneous** soft key, and then do the following(s) as needed:
 - To select the number of antenna ports, toggle the **MIMO** soft key and select **2x2** or **4x4**. This MIMO (Multiple Input Multiple Output) setting is activated only if the option 030 LTE-Advanced FDD is installed with a license number. If not, the instrument sets this option to 2x2 by default. A 2x1 or 4x1 RF combiner is also required to able to test on MIMO channels.
 - To assign a antenna port number automatically or manually, press the **Antenna Port** soft key and select the option: **Auto, 0, 1, 2**, and **3**. If the option 030 LTE-Advanced FDD is not installed or if the MIMO is set to 2x2, the antenna ports 2 and 3 are disabled.
 - To turn the Multimedia Broadcast Multicast Service (MBMS) feature on or off, toggle the **MBMS** soft key and select **On** or **Off**. For proper MBMS testing, you need to set the **Subframe No** with the same PMCH subframe number. If this setting is on, the measurement item “MBSFN RS” appears in the result table.
 - To set the Multicast Broadcast Single Frequency Network (MBSFN) detection automatically or manually for MBMS testing, toggle the **MBSFN** soft key and select **Auto** or **Manual**. An automatically detected or manually entered MBSFN ID appears on the screen.
 - To select the cyclic prefix, toggle the **Cyclic Prefix** soft key and select **Normal** or **Extended**. See “Appendix E – Cyclic prefix table” on page 545 for OFDM parameter details by different bandwidth.
 - To set the threshold for PDCCH, complete the following steps:
 - a. Press the **PDCCH Threshold** soft key.
 - b. Enter a value by using the numeric keys.
 - c. Press the **dB** soft key.
 - Toggle the **PDCCH Mode** soft key and select **REG** to calculate EVM based on Resource Element Group or **Avg** to calculate EVM after adding up all the PDCCH signals from one subframe.
-

Measurement example

Figure 84 Control channel measurement with LTE - FDD signal analyzer



Figure 85 Control channel measurement with LTE - FDD signal analyzer (MBMS On)



NOTE

You can use the **LIMIT** hot key to analyze your measurements with the user-definable limit and Pass/Fail indication. See “Setting limit for modulation tests” on page 213 for more information.

Using marker

You can use the **MARKER** hard key to place a marker on a control channel and display the I-Q diagram for the selected channel.

Procedure

1. Press the **MARKER** hard key.
 2. Press the **Channel** soft key to select the channel to be displayed in the IQ diagram. The channel P-SS is selected by default.
 3. Turn the rotary knob to move the highlight from one to another in the channel summary table.
 4. Toggle the **Marker View** soft key between **On** and **Off** to display or dismiss the result of the selected channel.
-

Subframe

The Subframe measures the modulation accuracy of all the data and control channels at the specified subframe (1 ms).

Setting measure setup

After configuring test parameters as described in the “Configuring test parameters” on page 179, you can continue your measurement. The measurement settings can be saved and recalled as a file.

Procedure

1. Press the **MEASURE SETUP** hot key.
2. To set the nominal channel bandwidth to be measured, complete the following steps:
 - a. Press the **Bandwidth** soft key.
 - b. Select the bandwidth option: **1.4 MHz**, **3 MHz**, **5 MHz**, **10 MHz**, **15 MHz**, or **20 MHz**.
3. To select the subframe number to be measured, complete the following steps:
 - a. Press the **Subframe No** soft key.
 - b. Enter a value by using the numeric keys. You can also use the rotary knob.

NOTE

For MBMS testing, this subframe number must be neither 0 nor 5 as these subframes 0 and 5 are not available for MBMS and it must be set to the MBMS transmitted channel's subframe number.

- c. Press the **Enter** soft key.
 4. *Optional.* Toggle the **Cell ID** soft key and select **Auto** or **Manual** as desired:
 - **Auto:** to let the instrument detect the Cell ID for the LTE signal automatically.
 - **Manual:** to set a specific Cell ID for the LTE signal manually in order to speed up the synchronization with a BTS.
 5. *Optional.* Toggle the **CFI** soft key and select **Auto** or **Manual** as desired:
 - **Auto:** to let the instrument set the number of OFDM symbols used for transmitting PDCCHs in a subframe.
 - **Manual:** to set the number of OFDM symbols manually. The set of OFDM symbols that can be used for PDCCH in a subframe is given by **0**, **2**, **3** or **4** in 1.4 MHz bandwidth and **1**, **2**, or **3** in other bandwidths.
 6. *Optional.* Press the **PHICH Ng** soft key, and then select the option for the number of PHICH groups (Ng): **1/6**, **1/2**, **1**, **2**, **E-1/6**, **E-1/2**, **E-1**, or **E-2**.
 7. Toggle the **EVM Detection Mode** soft key and select **Single** or **Combine** as desired:
 - **Single:** Testing on one single antenna connected to your JD780A series with a cable.
-

- **Combine:** Testing on multiple antennas connected to your JD780A series with a 2x1 or 4x1 combiner or an antenna.

8. Optional. Press the **Miscellaneous** soft key, and then do the following(s) as needed:

- To select the number of antenna ports, toggle the **MIMO** soft key and select **2x2** or **4x4**. This MIMO (Multiple Input Multiple Output) setting is activated only if the option 030 LTE-Advanced FDD is installed with a license number. If not, the instrument sets this option to 2x2 by default. A 2x1 or 4x1 RF combiner is also required to be able to test on MIMO channels.
- To assign an antenna port number automatically or manually, press the **Antenna Port** soft key and select the option: **Auto**, **0**, **1**, **2**, and **3**. If the option 030 LTE-Advanced FDD is not installed or if the MIMO is set to 2x2, the antenna ports 2 and 3 are disabled.
- To turn the Multimedia Broadcast Multicast Service (MBMS) feature on or off, toggle the **MBMS** soft key and select **On** or **Off**. For proper MBMS testing, you need to set the **Subframe No** with the same PMCH subframe number. If this setting is on, the measurement item “MBSFN RS” appears in the result table and either PMCH or PDSCH appears as well depending on the detected channel.
- To set the Multicast Broadcast Single Frequency Network (MBSFN) detection automatically or manually for MBMS testing, toggle the **MBSFN** soft key and select **Auto** or **Manual**. An automatically detected or manually entered MBSFN ID appears on the screen.
- To select the cyclic prefix, toggle the **Cyclic Prefix** soft key and select **Normal** or **Extended**. See “Appendix E – Cyclic prefix table” on page 545 for OFDM parameter details by different bandwidth.
- Press the **PDSCH Modulation Type** soft key, and then select the modulation type option: **Auto**, **QPSK**, **16 QAM**, **64 QAM**, **E-TM3.3**, **E-TM3.2**, **E-TM3.1**, **E-TM2**, **E-TM1.2**, and **E-TM1.1**. If two or more modulation types are used in a frame, select **Auto**. If the PDSCH uses the same modulation type in a frame or in a subframe, select a specific modulation type to get more accurate EVM.
- To set the threshold for PDSCH, complete the following steps:
 - a. Press the **PDSCH Threshold** soft key.
 - b. Enter a value by using the numeric keys.
 - c. Press the **dB** soft key.
- To set the threshold for PDCCH, complete the following steps:
 - a. Press the **PDCCH Threshold** soft key.
 - b. Enter a value by using the numeric keys.
 - c. Press the **dB** soft key.
- Toggle the **PDCCH Mode** soft key and select **REG** to calculate EVM based on Resource Element Group or **Avg** to calculate EVM after adding up all the PDCCH signals from one subframe.
- Toggle the **PDSCH Precoding** soft key between **On** and **Off** to enable or disable the PDSCH precoding.

Measurement example

Figure 86 Subframe measurement with LTE - FDD signal analyzer

1) Regular view



2) Chart view



Figure 87 Subframe measurement with LTE - FDD signal analyzer (MBMS On)



NOTE
You can use the **LIMIT** hot key to analyze your measurements with the user-definable limit and Pass/Fail indication. See “Setting limit for modulation tests” on page 213 for more information.

Setting display

You can use the **TRACE/DISPLAY** hard key to view the RE and RS power at the symbol.

Procedure

1. Press the **TRACE/DISPLAY** hard key.
2. Toggle the **Chart** soft key between **On** and **Off** to display or dismiss the chart. If this setting is on, the **MARKER** hard key is activated.

Using marker

If you turn the Chart view on, you can use the **MARKER** hard key to place the marker at a specific symbol.

Procedure

1. Press the **MARKER** hard key.
2. Toggle the **Marker View** soft key between **On** and **Off** to display or dismiss the marker on the chart.
3. Press the **Symbol** soft key to select the symbol number, to which the marker is placed.
4. Enter a value by using the numeric keys.
5. Press the **Enter** soft key.

Frame

The Frame measures the modulation accuracy of all the data and control channels at the frame (10 ms).

Setting measure setup

After configuring test parameters as described in the “Configuring test parameters” on page 179, you can continue your measurement. The measurement settings can be saved and recalled as a file.

Procedure

1. Press the **MEASURE SETUP** hot key.
 2. To set the nominal channel bandwidth to be measured, complete the following steps:
 - a. Press the **Bandwidth** soft key.
 - b. Select the bandwidth option: **1.4 MHz, 3 MHz, 5 MHz, 10 MHz, 15 MHz, or 20 MHz**.
 3. *Optional.* Toggle the **Cell ID** soft key and select **Auto** or **Manual** as desired:
 - **Auto:** to let the instrument detect the Cell ID for the LTE signal automatically.
 - **Manual:** to set a specific Cell ID for the LTE signal manually in order to speed up the synchronization with a BTS.
 4. *Optional.* Toggle the **CFI** soft key and select **Auto** or **Manual** as desired:
 - **Auto:** to let the instrument set the number of OFDM symbols used for transmitting PDCCHs in a subframe.
 - **Manual:** to set the number of OFDM symbols manually. The set of OFDM symbols that can be used for PDCCH in a subframe is given by **0, 2, 3 or 4** in 1.4 MHz bandwidth and **1, 2, or 3** in other bandwidths.
 5. *Optional.* Press the **PHICH Ng** soft key, and then select the option for the number of PHICH groups (Ng): **1/6, 1/2, 1, 2, E-1/6, E-1/2, E-1, or E-2**.
 6. Toggle the **EVM Detection Mode** soft key and select **Single** or **Combine** as desired:
 - **Single:** Testing on one single antenna connected to your JD780A series with a cable.
 - **Combine:** Testing on multiple antennas connected to your JD780A series with a 2x1 or 4x1 combiner or an antenna.
 7. *Optional.* Press the **Miscellaneous** soft key, and then do the following(s) as needed:
 - To select the number of antenna ports, toggle the **MIMO** soft key and select **2x2** or **4x4**. This MIMO (Multiple Input Multiple Output) setting is activated only if the option 030 LTE-Advanced FDD is installed with a license number. If not, the instrument sets this option to 2x2 by default. A 2x1 or 4x1 RF combiner is also required to be able to test on MIMO channels.
 - To assign an antenna port number automatically or manually, press the **Antenna Port** soft key and select the option: **Auto, 0, 1, 2, and 3**. If the option 030 LTE-Advanced FDD is not installed or if the MIMO is set to 2x2, the antenna ports 2 and 3 are disabled.
 - To turn the Multimedia Broadcast Multicast Service (MBMS) feature on or off, toggle the **MBMS** soft key and select **On** or **Off**. If this setting is on, the measurement items MBSFN RS, PMCH QPSK, PMCH 16 QAM, and PMCH 64 QAM appear in the result table.
 - To set the Multicast Broadcast Single Frequency Network (MBSFN) detection automatically or manually for MBMS testing, toggle the **MBSFN** soft key and select **Auto** or **Manual**. An automatically detected or manually entered MBSFN ID appears on the screen.
 - To select the cyclic prefix, toggle the **Cyclic Prefix** soft key and select **Normal** or **Extended**. See “Appendix E – Cyclic prefix table” on page 545 for OFDM parameter details by different bandwidth.
 - Press the **PDSCH Modulation Type** soft key, and then select the modulation type option: **Auto, QPSK, 16 QAM, 64 QAM, E-TM3.3, E-TM3.2, E-TM3.1, E-TM2, E-TM1.2, and E-TM1.1**. If two or more modulation types are used in a frame, select **Auto**. If the PDSCH uses the same modulation type in a frame or in a subframe, select a specific modulation type to get more accurate EVM.
-

- To set the threshold for PDSCH, complete the following steps:
 - a. Press the **PDSCH Threshold** soft key.
 - b. Enter a value by using the numeric keys.
 - c. Press the **dB** soft key.
- To set the threshold for PDCCH, complete the following steps:
 - a. Press the **PDCCH Threshold** soft key.
 - b. Enter a value by using the numeric keys.
 - c. Press the **dB** soft key.
- Toggle the **PDCCH Mode** soft key and select **REG** to calculate EVM based on Resource Element Group or **Avg** to calculate EVM after adding up all the PDCCH signals from one subframe.
- Toggle the **PDSCH Precoding** soft key between **On** and **Off** to enable or disable the PDSCH precoding.

Measurement example

Figure 88 Frame measurement with LTE - FDD signal analyzer



Figure 89 Frame measurement with LTE - FDD signal analyzer (MBMS On)

**NOTE**

You can use the **LIMIT** hot key to analyze your measurements with the user-definable limit and Pass/Fail indication. See “Setting limit for modulation tests” on page 213 for more information.

Time alignment error

In eNode B supporting Tx Diversity transmission, signals are transmitted from two or more antennas. These signals shall be aligned. The time alignment error in Tx diversity is specified as the delay between the signals from two antennas at the antenna ports.

Setting measure setup

After configuring test parameters as described in the “Configuring test parameters” on page 179, you can continue your measurement. The measurement settings can be saved and recalled as a file.

Procedure

1. Press the **MEASURE SETUP** hot key.
2. To set the nominal channel bandwidth to be measured, complete the following steps:
 - a. Press the **Bandwidth** soft key.
 - b. Select the bandwidth option: **1.4 MHz**, **3 MHz**, **5 MHz**, **10 MHz**, **15 MHz**, or **20 MHz**.
3. *Optional.* Toggle the **Cell ID** soft key and select **Auto** or **Manual** as desired:
 - **Auto:** to let the instrument detect the Cell ID for the LTE signal automatically.
 - **Manual:** to set a specific Cell ID for the LTE signal manually in order to speed up the synchronization with a BTS.
4. *Optional.* Press the **Miscellaneous** soft key, and then do the following(s) as needed:
 - To select the number of antenna ports, toggle the **MIMO** soft key and select **2x2** or **4x4**. This MIMO (Multiple Input Multiple Output) setting is activated only if the option 030 LTE-Advanced FDD is installed with a license number. If not, the instrument sets this option to 2x2 by default. A 2x1 or 4x1 RF combiner is also required to be able to test on MIMO channels.

- To assign a antenna port number automatically or manually, press the **Antenna Port** soft key and select the option: **Auto**, **0**, **1**, **2**, and **3**. If the option 030 LTE-Advanced FDD is not installed or if the MIMO is set to 2x2, the antenna ports 2 and 3 are disabled.
- To select the cyclic prefix, toggle the **Cyclic Prefix** soft key and select **Normal** or **Extended**. See “Appendix E – Cyclic prefix table” on page 545 for OFDM parameter details by different bandwidth.

Measurement example

Figure 90 Time alignment error measurement with LTE - FDD signal analyzer



NOTE
 You can use the **LIMIT** hot key to analyze your measurements with the user-definable limit and Pass/Fail indication. See “Setting limit for modulation tests” on page 213 for more information.

Data allocation map

The Data Allocation Map function represents data allocation as a frame.

Setting measure setup

After configuring test parameters as described in the “Configuring test parameters” on page 179, you can continue your measurement. The measurement settings can be saved and recalled as a file. You can also use JDViewer, PC application software to configure a measure setup, save as a file, and load the file on to the instrument.

Procedure

1. Press the **MEASURE SETUP** hot key.
2. To set the nominal channel bandwidth to be measured, complete the following steps:
 - a. Press the **Bandwidth** soft key.
 - b. Select the bandwidth option: **1.4 MHz**, **3 MHz**, **5 MHz**, **10 MHz**, **15 MHz**, or **20 MHz**.
3. To select the subframe number to be measured, complete the following steps:

- a. Press the **Subframe No** soft key.
- b. Enter a value by using the numeric keys. You can also use the rotary knob.

NOTE

For MBMS testing, this subframe number must be neither 0 nor 5 as these subframes 0 and 5 are not available for MBMS and it must be set to the MBMS transmitted channel's subframe number.

- c. Press the **Enter** soft key.
4. To set the threshold for PDSCH, complete the following steps:
 - a. Press the **PDSCH Threshold** soft key.
 - b. Enter a value by using the numeric keys.
 - c. Press the **dB** soft key.
 5. *Optional.* Toggle the **Cell ID** soft key and select **Auto** or **Manual** as desired:
 - **Auto:** to let the instrument detect the Cell ID for the LTE signal automatically.
 - **Manual:** to set a specific Cell ID for the LTE signal manually in order to speed up the synchronization with a BTS.
 6. *Optional.* Press the **Miscellaneous** soft key, and then do the following(s) as needed:
 - To select the number of antenna ports, toggle the **MIMO** soft key and select **2x2** or **4x4**. This MIMO (Multiple Input Multiple Output) setting is activated only if the option 030 LTE-Advanced FDD is installed with a license number. If not, the instrument sets this option to 2x2 by default. A 2x1 or 4x1 RF combiner is also required to able to test on MIMO channels.
 - To assign a antenna port number automatically or manually, press the **Antenna Port** soft key and select the option: **Auto**, **0**, **1**, **2**, and **3**. If the option 030 LTE-Advanced FDD is not installed or if the MIMO is set to 2x2, the antenna ports 2 and 3 are disabled.
 - To turn the Multimedia Broadcast Multicast Service (MBMS) feature on or off, toggle the **MBMS** soft key and select **On** or **Off**. For proper MBMS testing, you need to set the **Subframe No** with the same PMCH subframe number. If this setting is on, either PMCH or PDSCH appears on the screen depending on the detected channel.
 - To set the Multicast Broadcast Single Frequency Network (MBSFN) detection automatically or manually for MBMS testing, toggle the **MBSFN** soft key and select **Auto** or **Manual**. An automatically detected or manually entered MBSFN ID appears on the screen.
 - To select the cyclic prefix, toggle the **Cyclic Prefix** soft key and select **Normal** or **Extended**. See "Appendix E – Cyclic prefix table" on page 545 for OFDM parameter details by different bandwidth.

Measurement example

Figure 91 Data allocation map measurement with LTE - FDD signal analyzer



Figure 92 Data allocation map measurement with LTE - FDD signal analyzer (MBMS On)



NOTE

You can use the **LIMIT** hot key to analyze your measurements with the user-definable limit and Pass/Fail indication. See “Setting limit for modulation tests” on page 213 for more information.

Using marker

You can use the **MARKER** hard key to place the marker at a specific resource block and subframe.

Procedure

1. Press the **MARKER** hard key.

2. Toggle the **Marker View** soft key between **On** and **Off** to display or dismiss the marker on the chart.
3. To select the resource block number, complete the following steps:
 - a. Press the **RB Number** soft key.
 - b. Enter the resource block number to select by using the numeric keys. You can also use the rotary knob to move the marker side by side.
 - c. Press the **Enter** soft key.
4. To select the subframe block number, complete the following steps:
 - a. Press the **Subframe No** soft key.
 - b. Enter the subframe number to select by using the numeric keys. You can also use the rotary knob to move the marker up and down.
 - c. Press the **Enter** soft key.

Setting limit for modulation tests

Procedure

1. Press the **LIMIT** hot key.
2. Press the **Modulation Test Limits** soft key to set the limits.
3. Select the test item(s) and set the limit(s) depending on your selected measurement mode:

To set the limit for	Select	Set
Frequency error	Frequency Error	High Limit Low Limit
PDSCH error vector magnitude if MBMS is off	EVM > PDSCH EVM	High Limit (QPSK) High Limit (16 QAM) High Limit (64 QAM)
PMCH error vector magnitude if MBMS is on and a PMCH is detected	EVM > PMCH EVM	High Limit (QPSK) High Limit (16 QAM) High Limit (64 QAM)
RMS for data error vector magnitude	EVM > Data EVM RMS	High Limit
Peak for data error vector magnitude	EVM > Data EVM Peak	High Limit
RS error vector magnitude	EVM > RS EVM	High Limit
P-SS error vector magnitude	EVM > P-SS EVM	High Limit
S-SS error vector magnitude	EVM > S-SS EVM	High Limit
Downlink RS power	Power > DL RS Power	High Limit Low Limit
P-SS power	Power > P-SS Power	High Limit Low Limit
S-SS power	Power > S-SS Power	High Limit Low Limit
PBCH power	Power > PBCH Power	High Limit Low Limit

Subframe power	Power > Subframe Power	High Limit Low Limit
OFDM symbol power	Power > OFDM Symbol Power	High Limit Low Limit
Frame average power	Power > Frame Avg Power	High Limit Low Limit
Time alignment error for MIMO	Time Alignment Error > MIMO	High Limit
Time alignment error for aggregation of component carriers (intra-band contiguous, intra-band non-contiguous, and inter-band)	Time Alignment Error > Carrier Aggregation	Intra Cont Intra Non-cont Inter Band
Time error	Time Error	High Limit Low Limit
I-Q origin offset	IQ Origin Offset	High Limit

4. *Optional.* You can enable alarm sound that goes off if the measurement falls outside of the limit. Toggle the **Beep** soft key between **On** and **Off** to enable or disable the beep sound.
5. *Optional.* Go to **SAVE/LOAD > Save**, and then select **Limit** to save the limit settings. See “Using save” on page 31 for more information.

Performing auto measurements

Conformance test

The Conformance Test is to test if eNode-B meets some specified standards that have been developed for verification. Its test procedure and test setups have been developed by 3GPP. Test results can be saved as a .csv file type.

Setting limit for conformance test

You can set test limits for test item(s) in the auto measurement. Turning the test limit on for a test item makes the test item included in the conformance test.

Procedure

1. Press the **LIMIT** hot key.
2. To set the limit for BTS output power, complete the following steps:
 - a. Press the **BTS Output Power** soft key.
 - b. Toggle the **Test Limits** soft key between **On** and **Off** to enable or disable the limit.
 - c. Press the **High Limit** soft key.
 - d. Enter a value for the upper limit.
 - e. Press the **dBm** unit soft key.
 - f. Press the **Low Limit** soft key.
 - g. Enter a value for the lower limit.
 - h. Press the **dBm** unit soft key.
3. To set the limit for total power dynamic, complete the following steps:

- a. Press the **Total Power Dynamic** soft key.
 - b. Toggle the **Test Limits** soft key between **On** and **Off** to enable or disable the limit.
 - c. Press the **Low Limit** soft key.
 - d. Enter a value for the lower limit.
 - e. Press the **dBm** unit soft key.
4. To verify signal quality, press the **Signal Quality** soft key, and then do the following as needed:

To set the limit for	Select	Set
Frequency error	Frequency Error > Test Limits [E-TM2 E-TM3.1 E-TM3.2 E-TM3.3]	High Limit Low Limit
Error vector magnitude	EVM > Test Limits [E-TM2 E-TM3.1 E-TM3.2 E-TM3.3]	High Limit (QPSK) High Limit (16 QAM) High Limit (64 QAM)
Time alignment error	Time Alignment Error	High Limit
RS power	RS Power	High Limit Low Limit

5. To verify unwanted emissions, press the **Unwanted Emissions** soft key, and then do the following as needed:

To set the limit for	Select	Set
Occupied bandwidth	Occupied BW	High Limit
Adjacent channel power ratio	ACLR	
Spectrum emission mask	SEM	Mask Type
Spurious emissions	Spurious Emissions	Range Table

6. *Optional.* You can enable alarm sound that goes off if the measurement falls outside of the limit. Toggle the **Beep** soft key between **On** and **Off** to enable or disable the beep sound.
7. *Optional.* Go to **SAVE/LOAD > Save**, and then select **Limit** to save the limit settings. See "Using save" on page 31 for more information.

Setting measure setup

After setting frequency as described in the "Configuring test parameters" on page 179, you can continue your measurement.

Procedure

1. Press the **MEASURE SETUP** hot key.
2. Press the **Bandwidth** soft key.
3. Select the nominal channel bandwidth to be measured, from the following choices:
 - **1.4 MHz, 3 MHz, 5 MHz, 10 MHz, 15 MHz, and 20 MHz**
4. Press the **Sector** soft key, and then select the sector option: **Alpha**, **Beta**, or **Gamma**.
5. To set external offset, complete the following steps:
 - a. Toggle the **External Offset** soft key and select **On**.

-
- b. Enter a value by using the numeric keys.
 - c. Press the **dB** soft key.
6. To save your settings and results, go to **SAVE/LOAD > Save** and then perform functions as you desire. See “Using save” on page 31 for more information.
 7. Press the **Run Test** soft key to start to run a test.
The Auto Measure Results window appears at the end of the test.
 8. When prompted on the screen, connect the cable from the **Spectrum Analyzer RF In** port of the instrument either to **Antenna Port 0** or **Antenna Port 1** of the eNode-B, and then change the TM mode on the eNode-B side.
 9. Press the **Continue** soft key to continue testing.
 10. Repeat the steps 8-9 until completion of the test.
A conformance test report appears at the end of the test.
 11. *Optional.* To stop running the test, press the **Abort** soft key.
-

Maintenance test

The Auto Measure function of the JD780A series allows a complete signal profiling covering RF characterization and modulation quality parameters of up to 20 different carriers, particularly useful on an overlay architecture where base stations are transmitting in different frequencies.

Following settings are required only when you run the Auto Measure Maintenance Test on the instrument using “Current” configuration setting. Additional settings are not required when you run Auto Measure using a scenario generated in the PC application software, JDViewer.

Setting limit for maintenance test

You can set test limits for test item(s) in the auto measurement.

Procedure

1. Press the **LIMIT** hot key.
 2. Press the **RF Test Limits** soft key, and then enable test limits as desired.
 3. Press the **Modulation Test Limits** soft key, and then enable test limits as desired.
 4. *Optional.* You can enable alarm sound that goes off if the measurement falls outside of the limit. Toggle the **Beep** soft key between **On** and **Off** to enable or disable the beep sound.
 5. *Optional.* Go to **SAVE/LOAD > Save**, and then select **Limit** to save the limit settings. See “Using save” on page 31 for more information.
-

NOTE

You can use the **Allowed % Change** soft key for each test item to compare two measurement values displayed in the result table. This requires setting the **Display** mode to **Compare** in advance.

Setting measure setup

After configuring test parameters as described in the “Configuring test parameters” on page 179, you can continue your measurement. The measurement settings can be saved and recalled as a file. You can also use JDViewer, PC application software to configure a measure setup, save as a file, and load the file on to the instrument.

Procedure

1. Press the **MEASURE SETUP** hot key.
 2. Toggle the **Configuration** soft key and select the configuration option:
 - **Current**: to let the instrument use current frequency (single carrier) and determine pass or fail based on the instrument's limit settings in Auto Measure.
 - **Scenario**: to run a test with a programmed scenario in JDViewer. The Scenario menu becomes activated.
 3. To load a scenario, press the **Scenario** soft key, and then select a scenario file to load.
 4. Toggle the **Test Time** soft key and select the test time option:
 - **Now**: to let the instrument run a test only once.
 - **Schedule**: to let the instrument repeat tests as defined in the Set Timing. The Set Timing menu becomes activated.
 5. To define a schedule for an auto measurement, complete the following steps:
 - a. Press the **Set Timing** soft key.
 - b. Press the **Start Time (HH:MM)** soft key.
 - c. Enter the time in the HH:MM format, and then press the **Enter** soft key.
 - d. Press the **Stop Time (HH:MM)** soft key.
 - e. Enter the time in the HH:MM format, and then press the **Enter** soft key.
 - f. Press the **Time Interval** soft key.
 - g. Enter the amount of time in minutes, and then press the **Enter** soft key.
 -
 6. Press the **Settings** soft key, and then set the following as needed:
 - a. Press the **Bandwidth** soft key, and then select the nominal channel bandwidth to be measured, from the following choices:
 - **1.4 MHz, 3 MHz, 5 MHz, 10 MHz, 15 MHz, and 20 MHz**
 - b. Toggle the **Cell ID** soft key and select **Auto** or **Manual** as desired:
 - **Auto**: to let the instrument detect the Cell ID for the LTE signal automatically.
 - **Manual**: to set a specific Cell ID for the LTE signal manually in order to speed up the synchronization with a BTS.
 - c. Press the **MIMO** soft key, and then select the antenna number option: **2x2** or **4x4**. This MIMO (Multiple Input Multiple Output) setting is activated only if the option 030 LTE-Advanced FDD is installed with a license number. If not, the instrument sets this option to 2x2 by default. A 2x1 or 4x1 RF combiner is also required to be able to test on MIMO channels.
 - d. Press the **Antenna Port** soft key, and then select the option: **Auto, 0, 1, 2, or 3**. If the option 030 LTE-Advanced FDD is not installed or if the MIMO is set to 2x2, the antenna ports 2 and 3 are disabled.
 - e. Toggle the **External Offset** soft key and select **On**.
 - f. Enter a value by using the numeric keys, and then press the **dB** soft key.
 - g. To turn the Multimedia Broadcast Multicast Service (MBMS) feature on or off, toggle the **MBMS** soft key and select **On** or **Off**. For proper MBMS testing, you need to set the Subframe No with the same PMCH subframe number.
 - h. To set the Multicast Broadcast Single Frequency Network (MBSFN) detection automatically or manually for MBMS testing, toggle the **MBSFN** soft key and select **Auto** or **Manual**. An automatically detected or manually entered MBSFN ID appears on the screen.
 7. To save your settings and results, go to **SAVE/LOAD > Save** and then perform functions as you desire. See "Using save" on page 31 for more information.
-

-
8. Press the **Run Test** soft key to start to run a test.
The Auto Measure Results window appears at the end of the test.
 9. To stop running the test, press the **Abort** soft key.
 10. To change the view on the screen during the test, press the **Display** and then select the view option from the following choices:
 - **Screen:** You can view each measurement screen as the test progresses.
 - **Results:** You can view a measurement result table as the test progresses.
 - **Settings:** You can view a measurement setting table as the test progresses.
-

Setting display

After completion of the auto measurement, the screen menu changes to Trace/Display so that you can view the results in different forms.

Procedure

1. Toggle the **Display** soft key and select the display option:
 - **Result:** to view the result table.
The Display Result menu becomes activated.
 - **Settings:** to view the measurement settings for the auto measurement.
 2. Toggle the **Display Result** soft key and select the display result option:
 - **Full:** to view detailed measurement readings with the pass/fail indication.
 - **Quick:** to view only the Pass/Fail results.
 - **Compare:** to compare two measurement values for each test time with the Allowed % Change setting on. You can view results vs. factory-defined or user-defined references.
 3. To view the measurement results for a different carrier, press the **View Carrier** soft key and then select the carrier number to view.
 4. Press the **Replace Reference** soft key to replace existing reference values for comparison with new measurement data.
 5. Press the **Load From** soft key to select the location from which references file to be loaded.
-

Signal performance test

Unlike the other auto measurement tests, the Signal Performance Test runs measurements continuously.

Setting limit for signal performance test

You can set test limits for test item(s) in the auto measurement.

Procedure

1. Press the **LIMIT** hot key.
 2. Press the **RF Test Limits > Channel Power** soft key, and then set the limits for the channel power. Other RF test items are not used in the signal performance test.
 3. Press the **Modulation Test Limits** soft key, and then enable test limits as desired.
 4. *Optional.* You can enable alarm sound that goes off if the measurement falls outside of the limit.
-

Toggle the **Beep** soft key between **On** and **Off** to enable or disable the beep sound.

5. *Optional.* Go to **SAVE/LOAD > Save**, and then select **Limit** to save the limit settings. See "Using save" on page 31 for more information.
-

Setting measure setup

After configuring test parameters as described in the "Configuring test parameters" on page 179, you can continue your measurement. The measurement settings can be saved and recalled as a file. You can also use JDViewer, PC application software to configure a measure setup, save as a file, and load the file on to the instrument.

Procedure

1. Press the **MEASURE SETUP** hot key.
 2. Toggle the **Cell ID** soft key and select **Auto** or **Manual** as desired:
 - **Auto**: to let the instrument detect the Cell ID for the LTE signal automatically.
 - **Manual**: to set a specific Cell ID for the LTE signal manually in order to speed up the synchronization with a BTS.
 3. Press the **MIMO** soft key, and then select the antenna number option: **2x2** or **4x4**. This MIMO (Multiple Input Multiple Output) setting is activated only if the option 030 LTE-Advanced FDD is installed with a license number. If not, the instrument sets this option to 2x2 by default. A 2x1 or 4x1 RF combiner is also required to able to test on MIMO channels.
 4. Press the **Antenna Port** soft key, and then select the option: **Auto**, **0**, **1**, **2**, or **3**. If the option 030 LTE-Advanced FDD is not installed or if the MIMO is set to 2x2, the antenna ports 2 and 3 are disabled.
 5. Press the **Bandwidth** soft key, and then select the nominal channel bandwidth to be measured, from the following choices:
 - **1.4 MHz, 3 MHz, 5 MHz, 10 MHz, 15 MHz, and 20 MHz**
 6. Toggle the **RF Profile** soft key between **On** and **Off** to turn on or off the RF profiling such as channel power and subframe frequency error.
 7. Toggle the **Modulation Profile** soft key between **On** and **Off** to turn on or off the modulation profiling such as P-SS, S-SS, Data - QPSK, Data – 16 QAM, and Data – 64 QAM.
 8. Toggle the **MIMO Profile** soft key between **On** and **Off** to turn on or off the MIMO profiling such as TX1 - RS0, TX2 - RS1, and time alignment error.
 9. Toggle the **External Offset** soft key and select **On** to set the external offset value.
 10. To save your settings and results, go to **SAVE/LOAD > Save** and then perform functions as you desire. See "Using save" on page 31 for more information.
-

DAS test

The Distributed Antenna System (DAS) testing enables you to check the degradation of performance in the signal transmission from a radio band to antennas distributed from it. You can save measurement values at both the radio band and antennas and then compare results with percentage of changes. You can also save test results in the `.csv` file format for ease of analysis.

Setting measure setup

Procedure

1. Press the **MEASURE SETUP** hot key.
-

-
2. Press the **Settings** soft key and then set the following;
 - a. Press the **Bandwidth** soft key and then select the nominal channel bandwidth to be measured from the choices: **1.4 MHz, 3 MHz, 5 MHz, 10 MHz, 15 MHz, and 20 MHz**:
 - b. Press the **MIMO** soft key, and then select the antenna number option: **2x2** or **4x4**. This MIMO (Multiple Input Multiple Output) setting is activated only if the option 030 LTE-Advanced FDD is installed with a license number. If not, the instrument sets this option to 2x2 by default. A 2x1 or 4x1 RF combiner is also required to be able to test on MIMO channels.
 - c. Toggle the **Cell ID** soft key and select **Auto** or **Manual** as desired:
 - **Auto**: to let the instrument detect the Cell ID for the LTE signal automatically.
 - **Manual**: to set a specific Cell ID for the LTE signal manually in order to speed up the synchronization with a BTS.
 - d. Press the **Antenna Port** soft key, and then select the option: **Auto, 0, 1, 2, or 3**. If the option 030 LTE-Advanced FDD is not installed or if the MIMO is set to 2x2, the antenna ports 2 and 3 are disabled.
 - e. Toggle the **External Offset** soft key and select **On** to set the external offset value.
 - f. To turn the Multimedia Broadcast Multicast Service (MBMS) feature on or off, toggle the **MBMS** soft key and select **On** or **Off**.
 - g. To set the Multicast Broadcast Single Frequency Network (MBSFN) detection automatically or manually for MBMS testing, toggle the **MBSFN** soft key and select **Auto** or **Manual**. An automatically detected or manually entered MBSFN ID appears on the screen.
 3. To save your settings, go to **SAVE/LOAD > Save > Save Setup** and then perform functions as you desire. See "Using save" on page 31 for more information.
 4. Press the **Continue** soft key to do the reference test first or press the **Skip Reference Test** soft key if you already saved test results from the radio band under test.
 5. Press the **FREQ/DIST** hard key and then set the frequency to be measured. See "Setting frequency" on page 243 for more information.
 6. Press the **PREV** hard key.
 7. Press the **Limit** soft key and then set the limits and allowed percentage change for each test item. See "Maintenance test" on page 280 for more information on setting limits.
 8. Keep pressing the **PREV** hard key until you see the Run Test soft key.
 9. Press the **Run Test** soft key.

The instrument runs specified tests to gather reference measurement values. The measurement table appears when the reference test is done.
 10. Press the **Continue** soft key to run the testing on an antenna (Ant 1).
 11. *Optional.* To change the settings such as **External Offset**, press the **Settings** and then change the settings as needed.
 12. Press the **Continue** soft key.

The instrument runs the testing on Ant 1. The Ant 1 tab appears with the updated result table when the test is done.
 13. To run the testing on the next antenna (Ant 2), press the **Run Test** soft key and then repeat the steps 11-12. You can do the testing on up to 10 distributed antennas for one radio band.
 14. To view test results for each antenna, press the **Select Antenna** soft key and then select the antenna tab number to display on the screen.
 15. *Optional.* Press the **Delete Test** soft key to delete the selected antenna tab.
 16. *Optional.* Press the **Retest Reference** soft key to obtain reference measurement values again.
 17. *Optional.* To save your measurement results, go to **SAVE/LOAD > Save** and then perform functions as you desire. See "Using save" on page 31 for more information.
-

Measurement Example

Figure 93 DAS measurement with LTE - FDD signal analyzer

Measurement Description	Low Limit	High Limit	Allowed % Change	Measurement Reference	Measurement Value	Difference	Percent Change
Channel Power	40.00	42.00	5.00	38.94	38.89	-0.05	-0.35
OBW	10.00	10.00	5.00	9.08	9.08	0.00	0.00
Frame Avg Power	36.00	40.00	5.00	38.88	38.87	-0.01	-0.02
TAE	90.00	90.00	5.00				
Frequency Error	-0.05	0.05	5.00	0.004	0.007	0.003	80.30
QPSK EVM	18.50	18.50	5.00				
16 QAM EVM	13.50	13.50	5.00				
64 QAM EVM	9.00	9.00	5.00	0.93	0.92	-0.01	-0.27
Data EVM RMS	18.50	18.50	5.00	0.93	0.92	-0.01	-0.27
Data EVM Peak	18.50	18.50	5.00	4.46	4.23	-0.23	-5.15
RS EVM	18.50	18.50	5.00	0.82	0.96	0.14	12.40
P-SS EVM	18.50	18.50	5.00				
S-SS EVM	18.50	18.50	5.00				
RS Power	13.00	18.00	5.00				
P-SS Power	18.00	22.00	5.00				
S-SS Power	18.00	22.00	5.00				
PBCH Power	18.00	22.00	5.00				
Subframe Power	18.00	22.00	5.00				
OFDM Symbol Pwr	18.00	22.00	5.00				
Time Error	-2.00	2.00	5.00				
IQ Origin Offset		-30.00	5.00				
ID (Cell, Gps, Sec)				1,0,1	1,0,1		

Performing power statistics CCDF measurements

The Power Statistics Complementary Cumulative Distribution Function (CCDF) measurement characterizes the power statistics of the input signal. It provides PAR (Peak to Average power Ratio) versus different probabilities.

Setting measure setup

After configuring test parameters as described in the “Configuring test parameters” on page 179, you can continue your measurement. The measurement settings can be saved and recalled as a file. You can also use JDViewer, PC application software to configure a measure setup, save as a file, and load the file on to the instrument.

Procedure

1. Press the **MEASURE SETUP** hot key.
2. Press the **CCDF Length** soft key to set the length of the CCDF.
3. Enter a value between 1 and 100 by using the numeric keys. You can also use the rotary knob.
4. Press the **Enter** soft key.

Measurement example

Figure 94 CCDF measurement with LTE - FDD signal analyzer



Performing carrier aggregation measurements

Carrier aggregation enables a maximum of five multiple LTE carriers to be used together in order to provide high data rate required for LTE-Advanced. Component carriers to be aggregated can be intra-band contiguous, intra-band non-contiguous, or inter-band. The JD780A series provides carrier aggregation measurements supporting for all the different modes with carrier aggregation bands added to the channel standard. This functionality is activated if the license for the option 030 LTE-Advanced FDD is installed.

Setting measure setup

After configuring test parameters as described in the “Configuring test parameters” on page 179, you can continue your measurement. The measurement settings can be saved and recalled as a file. You can also use JDViewer, PC application software to configure a measure setup, save as a file, and load the file on to the instrument.

Procedure

1. Press the **MEASURE SETUP** hot key.
2. To configure parameters for up to 5 component carriers, complete the following steps:
 - a. Press the **CA Configuration** soft key.
The component carrier configuration window appears.
 - b. Press the **CA Range** soft key.
 - c. Enter the number of the component carrier to be set between 1 and 5.
 - d. Press the **Enter** soft key.
 - e. Toggle the **Turn On** soft key and then select **On** to set parameters and view the results for the selected component carrier on the screen or **Off** to turn it off.
 - f. Set the following parameters as needed:

-
- **Center Frequency, Channel, Bandwidth, Cell ID, CFI, PHICH Ng, Antenna Port, MBMS On/Off, Cyclic Prefix, and PDSCH Modulation Type**
- g. To set more component carriers, repeat the steps **c-f**.
3. Press the **MEASURE SETUP** hot key again
 4. Toggle the **EVM Detection Mode** soft key and select **Single** or **Combine** as desired:
 - **Single:** Testing on one single antenna connected to your JD780A series with a cable.
 - **Combine:** Testing on multiple antennas connected to your JD780A series with a 2x1 or 4x1 combiner or an antenna.
 5. To select the subframe number to be measured, do one of the following:
 - If the **EVM Detection Mode** is set to **Single**, press the **Subframe No** soft key and then set the subframe number.

NOTE

For MBMS testing, this subframe number must be neither 0 nor 5 as these subframes 0 and 5 are not available for MBMS and it must be set to the MBMS transmitted channel's subframe number.

- If the **EVM Detection Mode** is set to **Combine**, toggle the **Subframe No** soft key and then select **0** or **5**.
6. To set the threshold for PDSCH, complete the following steps:
 - a. Press the **PDSCH Threshold** soft key.
 - b. Enter a value by using the numeric keys.
 - c. Press the **dB** soft key.
 7. Toggle the **PDSCH Precoding** soft key between **On** and **Off** to enable or disable the PDSCH precoding.
 8. To select the number of antenna ports, toggle the **MIMO** soft key and select **2x2** or **4x4**. This MIMO (Multiple Input Multiple Output) setting is activated only if the option 030 LTE-Advanced FDD is installed with a license number. If not, the instrument sets this option to 2x2 by default. A 2x1 or 4x1 RF combiner is also required to able to test on MIMO channels.
-

Setting display

You can use the **TRACE/DISPLAY** hard key to select modulation analysis or spectrum analysis.

Procedure

1. Press the **TRACE/DISPLAY** hard key.
 2. Toggle the **Display** soft key and select **MA** for modulation analysis or **SA** for spectrum analysis. The screen changes according to the selected option.
-

Measurement example

Figure 95 Carrier aggregation measurement with LTE - FDD signal analyzer (MA)



Figure 96 Carrier aggregation measurement with LTE - FDD signal analyzer (SA)



NOTE

You can use the **LIMIT** hot key to analyze your measurements with the user-definable limit and Pass/Fail indication. See “Setting limit for modulation tests” on page 213 for more information.

Using marker

You can use the **MARKER** hard key to place the marker at a specific channel.

Procedure

1. Press the **MARKER** hard key.

2. Toggle the **IQ Diagram** soft key between **On** and **Off** to display or dismiss data on the IQ diagram for each component carrier.
3. Press the **Channel** soft key to select the channel to be displayed on the IQ diagram.
4. Use the rotary knob to move and select an item under EVM.

Conducting LTE - FDD OTA measurements

The FDD LTE Over The Air (OTA) measurement has Channel Scanner, ID Scanner, Multipath Profile, Datagram, and Control Channel screens. The ID Scanner displays key parameters such as RSRP, RSRQ, RS-SINR, and S-SS RSSI. The Multipath Profile enables you to determine RF environmental conditions of testing area. The OTA Control Channel provides summary of all control channels including RS power variation over time.

Channel scanner

The Channel Scanner is a radio receiver that can automatically tune or scan two or more discrete frequencies and multi-channels, indicating when it finds a signal on one of them and then continuing scanning when that frequency goes silent.

Setting channel/frequency

Procedure

To set the channels to be scanned:

1. Press the **FREQ/DIST** hard key.
 2. Toggle the **Unit** soft key and select **Channel**.
 3. Press the **Index** soft key, and then enter an index number between one and six by turning the rotary knob or using the numeric keys.
 4. To select the standard channel, complete the following steps:
 - a. Press the **Channel Std** soft key. The standard channel window appears. See "Appendix C – Band, frequency & channel standard" on page 541 for more information.
 - b. Select the band to be measured by using the rotary knob, the arrow keys, or the **Page Up/Page Down** soft keys.
 - c. Press the **Select** soft key or the rotary knob to confirm the selection.
 5. To set the channel number for the selected index, complete the following steps:
 - a. Press the **Channel Number** soft key.
 - b. Enter a value by using the numeric keys. You can also use the rotary knob.
 - c. Press the **Enter** soft key.

The instrument displays a corresponding center frequency for the channel number.
 6. To set the integration bandwidth for the selected index, complete the following steps:
 - a. Press the **Integration Bandwidth** soft key.
 - b. Enter a value by using the numeric keys. You can also use the rotary knob.
 - c. Select the unit: **GHz**, **MHz**, **kHz**, or **Hz**.
 7. To add more channels to be scanned, repeat steps 3-6.
 8. Press the **ESC** hard key to dismiss the channel list window and view the scanning result.
-

To set the frequencies to be scanned:

1. Press the **FREQ/DIST** hard key.
2. Toggle the **Unit** soft key and select **Freq**.
3. Press the **Index** soft key, and then enter an index number between one and six by turning the rotary knob or using the numeric keys.
4. To set the center frequency for the selected index, complete the following steps:
 - a. Press the **Center Frequency** soft key.
 - b. Enter a value by using the numeric keys. You can also use the rotary knob.
 - c. Select the unit: **GHz, MHz, kHz, or Hz**.
5. To set the integration bandwidth for the selected index, complete the following steps:
 - a. Press the **Integration Bandwidth** soft key.
 - b. Enter a value by using the numeric keys. You can also use the rotary knob.
 - c. Select the unit: **GHz, MHz, kHz, or Hz**.
6. To add more channels to be scanned, repeat steps 3-5.
7. Press the **ESC** hard key to dismiss the channel list window and view the scanning result.

Setting number of antenna ports

Procedure

1. Press the **MEASURE SETUP** hot key.
2. Toggle the **MIMO** soft key and select **2x2** or **4x4**.
 This MIMO (Multiple Input Multiple Output) setting is activated only if the option 030 LTE-Advanced FDD is installed with a license number. If not, the instrument sets this option to 2x2 by default. A 2x1 or 4x1 RF combiner is also required to be able to test on MIMO channels.

Measurement example

Figure 97 Channel scanner measurement with LTE - FDD OTA signal analyzer



ID scanner

The LTE mobile receives signals from multiple base stations that all of these signals share the same spectrum and are present at the same time. Each base station has unique scrambling code assigned to the particular base station and it differentiates its signal from other base stations in the area.

The ID Scanner shows key parameters such as RSRP (Reference Signal Received Power) and RSRQ (Reference Signal Received Quality) that predict the downlink coverage quickly.

- RSRPs from entire cells help to rank between the different cells as input for handover and cell reselection decisions.
- RSRQ provides additional information when RSRP is not sufficient to make a reliable handover or cell reselection decision.

All of the parameters for OTA ID scanner can be plotted on map data such as Google Maps and Google Earth by using JDViewer.

Setting measure setup

After configuring test parameters as described in the “Configuring test parameters” on page 179, you can continue your measurement.

Procedure

1. Press the **MEASURE SETUP** hot key.
 2. To set the nominal channel bandwidth to be measured, complete the following steps:
 - a. Press the **Bandwidth** soft key.
 - b. Select the bandwidth option: **1.4 MHz**, **3 MHz**, **5 MHz**, **10 MHz**, **15 MHz**, or **20 MHz**.
 3. *Optional.* Press the **Miscellaneous** soft key, and then do the following(s) as needed:
 - To select the number of antenna ports, toggle the **MIMO** soft key and select **2x2** or **4x4**. This MIMO (Multiple Input Multiple Output) setting is activated only if the option 030 LTE-Advanced FDD is installed with a license number. If not, the instrument sets this option to 2x2 by default. A 2x1 or 4x1 RF combiner is also required to able to test on MIMO channels.
 - To select the cyclic prefix, toggle the **Cyclic Prefix** soft key and select **Normal** or **Extended**. See “Appendix E – Cyclic prefix table” on page 545 for OFDM parameter details by different bandwidth.
 4. *Optional.* Go to **SAVE/LOAD > Save**, and then select the save option from the choices available for your measurement mode. See “Using save” on page 31 for more information.
-

Measurement example

Figure 98 ID scanner measurement with LTE - FDD OTA signal analyzer



Multipath profile

The Multipath Profile enables you to determine RF environmental conditions of testing area. It indicates the amount of power of the dominant pilot signal that is dispersed outside the main correlation peak due to multipath echoes that are expressed in dB. This value should be very small ideally.

The multipath profile is the result of portions of the original broadcast signal arriving at the receiving antenna out of phase. This can be caused by the signal being reflected off objects such as buildings, or being refracted through the atmosphere differently from the main signal.

Setting measure setup

After configuring test parameters as described in the “Configuring test parameters” on page 179, you can continue your measurement.

Procedure

1. Press the **MEASURE SETUP** hot key.
2. To set the nominal channel bandwidth to be measured, complete the following steps:
 - a. Press the **Bandwidth** soft key.
 - b. Select the bandwidth option: **1.4 MHz**, **3 MHz**, **5 MHz**, **10 MHz**, **15 MHz**, or **20 MHz**.
3. Toggle the **Display** soft key and select **RS** or **Sync**.
The RS Window soft key becomes activated if RS is selected.
4. Press the **RS Window** soft key, if RS is selected, and then select the RS window option: **2 μs**, **4 μs**, or **8 μs**.
5. *Optional.* Press the **Miscellaneous** soft key, and then do the following(s) as needed:
 - To select the number of antenna ports, toggle the **MIMO** soft key and select **2x2** or **4x4**. This MIMO (Multiple Input Multiple Output) setting is activated only if the option 030 LTE-Advanced FDD is installed with a license number. If not, the instrument sets this option to

2x2 by default. A 2x1 or 4x1 RF combiner is also required to able to test on MIMO channels.

- To select the cyclic prefix, toggle the **Cyclic Prefix** soft key and select **Normal** or **Extended**. See “Appendix E – Cyclic prefix table” on page 545 for OFDM parameter details by different bandwidth.

6. *Optional.* Go to **SAVE/LOAD > Save**, and then select the save option from the choices available for your measurement mode. See “Using save” on page 31 for more information.

Measurement example

Figure 99 Multipath profile measurement with LTE - FDD OTA signal analyzer



Control channel

DL RS power is the resource element power of Downlink Reference Symbol. The absolute DL RS power is indicated on the BCH. The absolute accuracy is defined as the maximum deviation between the DL RS power indicated on the BCH and the DL RS power at the BS antenna connector.

The OTA Control Channel provides summary of all control channels including RS power trend over time. GPS coordinates (latitude and longitude) will be displayed on the screen if a GPS antenna is connected and locked to the GPS satellites.

Setting measure setup

After configuring test parameters as described in the “Configuring test parameters” on page 179, you can continue your measurement. The measurement settings can be saved and recalled as a file. You can also use JDViewer, PC application software to configure a measure setup, save as a file, and load the file on to the instrument.

Procedure

1. Press the **MEASURE SETUP** hot key.
2. To set the nominal channel bandwidth to be measured, complete the following steps:
 - a. Press the **Bandwidth** soft key.

- b. Select the bandwidth option: **1.4 MHz, 3 MHz, 5 MHz, 10 MHz, 15 MHz, or 20 MHz.**
- 3. To select the subframe number to be measured, complete the following steps:
 - a. Press the **Subframe No** soft key.
 - b. Enter a value by using the numeric keys. You can also use the rotary knob.

NOTE

For MBMS testing, this subframe number must be neither 0 nor 5 as these subframes 0 and 5 are not available for MBMS and it must be set to the MBMS transmitted channel's subframe number.

- c. Press the **Enter** soft key.
- 4. *Optional.* Toggle the **Cell ID** soft key and select **Auto** or **Manual** as desired:
 - **Auto:** to let the instrument detect the Cell ID for the LTE signal automatically.
 - **Manual:** to set a specific Cell ID for the LTE signal manually in order to speed up the synchronization with a BTS.
- 5. *Optional.* Press the **Miscellaneous** soft key, and then do the following(s) as needed:
 - To select the number of antenna ports, toggle the **MIMO** soft key and select **2x2** or **4x4**. This MIMO (Multiple Input Multiple Output) setting is activated only if the option 030 LTE-Advanced FDD is installed with a license number. If not, the instrument sets this option to 2x2 by default. A 2x1 or 4x1 RF combiner is also required to able to test on MIMO channels.
 - To assign a antenna port number automatically or manually, press the **Antenna Port** soft key and select the option: **Auto, 0, 1, 2, and 3**. If the option 030 LTE-Advanced FDD is not installed or if the MIMO is set to 2x2, the antenna ports 2 and 3 are disabled.
 - To select the cyclic prefix, toggle the **Cyclic Prefix** soft key and select **Normal** or **Extended**. See "Appendix E – Cyclic prefix table" on page 545 for OFDM parameter details by different bandwidth.
 - To turn the Multimedia Broadcast Multicast Service (MBMS) feature on or off, toggle the **MBMS** soft key and select **On** or **Off**. For proper MBMS testing, you need to set the **Subframe No** with the same PMCH subframe number. If this setting is on, the measurement item "MBSFN RS" appears in the result table.
 - To set the Multicast Broadcast Single Frequency Network (MBSFN) detection automatically or manually for MBMS testing, toggle the **MBSFN** soft key and select **Auto** or **Manual**. An automatically detected or manually entered MBSFN ID appears on the screen.
- 6. *Optional.* Go to **SAVE/LOAD > Save**, and then select the save option from the choices available for your measurement mode. See "Using save" on page 31 for more information.

Setting limit for OTA control channel

Procedure

1. Press the **LIMIT** hot key.
2. Select the test item(s) and set the limit(s) as needed:

To set the limit for	Select	Set
P-SS error vector magnitude	P-SS EVM	High Limit
S-SS error vector magnitude	S-SS EVM	High Limit
RS error vector magnitude	RS EVM > RS0 EVM RS EVM > RS1 EVM RS EVM > RS2 EVM RS EVM > RS3 EVM	High Limit

Frequency error	Frequency Error	High Limit Low Limit
Time error	Time Error	High Limit Low Limit
Time alignment error	Time Alignment Error	High Limit

3. *Optional.* Go to **SAVE/LOAD > Save**, and then select **Limit** to save the limit settings. See “Using save” on page 31 for more information.

Setting display

You can use the **TRACE/DISPLAY** hard key to select the display option.

Procedure

1. Press the **TRACE/DISPLAY** hard key.
2. Toggle the **Display** soft key and select **Power** or **EVM**. The screen changes according to the selected option.

Measurement example

Figure 100 Control channel measurement with LTE - FDD OTA signal analyzer



Datagram

The OTA Datagram is a time-varying spectral representation that shows how the power of a signal varies with time. The power allocated to the specific resource block will be represented with an amplitude axis (in dBm) and the waterfall diagram will show the trend of past resource block power over certain period. Using a marker function facilitates analysis of accumulated resource block power for data utilization.

Setting measure setup

After configuring test parameters as described in the “Configuring test parameters” on page 179, you

can continue your measurement. The measurement settings can be saved and recalled as a file. You can also use JDViewer, PC application software to configure a measure setup, save as a file, and load the file on to the instrument.

Procedure

1. Press the **MEASURE SETUP** hot key.
2. To set the nominal channel bandwidth to be measured, complete the following steps:
 - a. Press the **Bandwidth** soft key.
 - b. Select the bandwidth option: **1.4 MHz, 3 MHz, 5 MHz, 10 MHz, 15 MHz, or 20 MHz.**
3. To select the subframe number to be measured, complete the following steps:
 - a. Press the **Subframe No** soft key.
 - b. Enter a value by using the numeric keys. You can also use the rotary knob.
 - c. Press the **Enter** soft key.
4. *Optional.* Toggle the **Cell ID** soft key and select **Auto** or **Manual** as desired:
 - **Auto:** to let the instrument detect the Cell ID for the LTE signal automatically.
 - **Manual:** to set a specific Cell ID for the LTE signal manually in order to speed up the synchronization with a BTS.
5. *Optional.* To set the threshold for PDSCH, complete the following steps:
 - a. Press the **PDSCH Threshold** soft key.
 - b. Enter a value by using the numeric keys.
 - c. Press the **dB** soft key.
6. To set the time cursor at a specific position, complete the following steps:
 - a. Toggle the **Time Cursor** soft key and select **On**.
 - b. Turn the rotary knob to move the time cursor. You can also enter a value and then press the **Enter** soft key.

NOTE

Enabling the time cursor puts the measurement on hold and you can make post-processing analysis for each measurement over time using the time cursor.

7. To start a new measurement, press the **Reset/Restart** soft key.
 8. *Optional.* Press the **Miscellaneous** soft key, and then do the following(s) as needed:
 - To select the number of antenna ports, toggle the **MIMO** soft key and select **2x2** or **4x4**. This MIMO (Multiple Input Multiple Output) setting is activated only if the option 030 LTE-Advanced FDD is installed with a license number. If not, the instrument sets this option to 2x2 by default. A 2x1 or 4x1 RF combiner is also required to able to test on MIMO channels.
 - To select the cyclic prefix, toggle the **Cyclic Prefix** soft key and select **Normal** or **Extended**. See “Appendix E – Cyclic prefix table” on page 545 for OFDM parameter details by different bandwidth.
 9. *Optional.* Go to **SAVE/LOAD > Save**, and then select the save option from the choices available for your measurement mode. See “Using save” on page 31 for more information.
-

Measurement example

Figure 101 Datagram measurement with LTE - FDD signal analyzer



Route map

The JD780A Series provides indoor and outdoor mapping function that allows a user to collect data of points in an indoor or outdoor environment and track the received signals and coverage of RF transmitters plotting real time directly on top of a loaded floor plan or a map.

Setting measure setup

Procedure

1. If required, connect a GPS receiver to your JD780A series for outdoor mapping. Indoor mapping does not necessarily need a GPS antenna.
2. Configure test parameters as described in the “Configuring test parameters” on page 179.
3. To load your map file, complete the following steps:
 - a. Plug in your USB drive that has a floor map or .mcf file type created in JDMapCreator.

NOTE

The JDMapCreator converts and resizes any scanned floor plan or layout to fit onto your instrument’s display. You must save your map files (.mcf) into the “SavedMap” folder of your USB drive so that you can load them onto your instrument.

- b. Press **SAVE/LOAD** hot key, and then select **Load > Load Map**. See “Using load” on page 34 for more information.
4. Press the **MEASURE SETUP** hot key.
5. Press the **Plot Point** soft key, and then select the plot point option from the following choices:
 - To collect data/plot points automatically as you move around in a vehicle or outside, press the **GPS** soft key and then toggle the **Screen Mode** soft key between **Map** and **Full**.

NOTE

With the **Map** setting, you can view only the collected points that can be seen within the boundary of the loaded map. If a point is off the map, the instrument displays an arrow to indicate the direction of the current location on the map and the distance from the center to the location at the top of the screen.

With the **Full** setting, you can view all the collected points of the route without the loaded map.

- To collect data/plot points manually without a GPS antenna in an indoor environment, press the **Position** soft key.

6. Press the **Plot Item** soft key, and then select the measurement option: **RSRP**, **RSRQ**, **RS-SINR**, **S-SS RSSI**, **P-SS Power**, **S-SS Power**, or **S-SS Ec/Io**.

NOTE

The instrument collects the strongest Cell ID's data to plot points.

7. Press the **Bandwidth** soft key to set the nominal channel bandwidth to be measured, and then select the bandwidth option: **1.4 MHz**, **3 MHz**, **5 MHz**, **10 MHz**, **15 MHz**, or **20 MHz**.
8. Toggle the **Plot** soft key and select **Start** to start plotting.
9. Touch directly on the screen or press the **ENTER** hard key to collect data and plot points on the loaded map for the **Position** setting.

NOTE

For the **Position** setting, you can change the direction of the route with the arrow keys and the distance with the rotary knob.

10. Toggle the **Plot** soft key and select **Stop** to stop plotting.
11. Press the **SAVE/LOAD** hot key to save the result.
See "Using save" on page 31 for more information.

NOTE

The instrument does not automatically save the collected data. It is recommended that you save the result. Otherwise, you will lose all the collected data.

Setting limit for route map

You can set the thresholds for each test item.

Procedure

1. Press the **LIMIT** hot key.
2. Select the plot items and set the limits as needed:

To set the limit for	Select	Set
RSRP	RSRP	Excellent, Very Good, Good, Fair, Poor (dBm)
RSRQ	RSRQ	Good, Fair, Poor (dB)
RS-SINR	RS-SINR	Good, Fair, Poor (dB)
S-SS RSSI	S-SS RSSI	Excellent, Very Good, Good, Fair, Poor (dBm)
P-SS Power	P-SS Power	Excellent, Very Good, Good, Fair, Poor (dBm)
S-SS Power	S-SS Power	Excellent, Very Good, Good, Fair, Poor (dBm)
S-SS Ec/Io	S-SS Ec/Io	Good, Fair, Poor (dB)

3. *Optional.* Go to **SAVE/LOAD > Save**, and then select **Limit** to save the limit settings.
See "Using save" on page 31 for more information.

Measurement example

Figure 102 Route map measurement with LTE - FDD OTA signal analyzer

1) RSRP



2) RSRQ



3) RS-SINR



4) S-SS RSSI



5) P-SS Power



6) S-SS Power



7) S-SS Ec/Io



Using LTE - TDD Signal Analyzer

This chapter provides instructions for using the LTE - TDD Signal Analyzer (option 029) and LTE-Advanced TDD Analyzer (option 031) with the LTE - TDD OTA Analyzer (option 049). Topics discussed in this chapter are as follows:

■ Introduction	239
■ Display overview	240
■ Connecting a cable	240
■ Selecting measurement mode	242
■ Configuring test parameters	242
■ Conducting spectrum measurements	247
■ Conducting RF measurements	249
■ Conducting power vs. time measurements	258
■ Conducting modulation measurements	261
■ Performing auto measurements	279
■ Performing power statistics CCDF measurements	286
■ Performing carrier aggregation measurements	287
■ Conducting LTE - TDD OTA measurements	290

Introduction

The LTE (Long-Term Evolution) Signal Analyzer of the JD780A series performs power and spectrum measurements as well as modulation analysis to test the proper transmitter performance of TDD LTE systems. It performs conformance testing according to the following standards providing a simple Pass/Fail indication on each test.

- 3GPP TS 36.104. Evolved Universal Terrestrial Radio Access (E-UTRA); Base Station (BS) Radio Transmission and Reception
- 3GPP TS 36.141. Evolved Universal Terrestrial Radio Access (E-UTRA); Base Station (BS) Conformance Testing
- 3GPP TS 36.211. Evolved Universal Terrestrial Radio Access (E-UTRA); Physical Channels and Modulation
- 3GPP TS 36.212. Evolved Universal Terrestrial Radio Access (E-UTRA); Multiplexing and Channel Coding
- 3GPP TS 36.213 V8.2.0. Evolved Universal Terrestrial Radio Access (E-UTRA); Physical Layer Procedures

This instrument provides the following measurement tools for TDD LTE system:

- Spectrum Analysis
- RF Analysis
 - Channel Power
 - Occupied Bandwidth
 - Spectrum Emission Mask
 - Adjacent Channel Leakage power Ratio (ACLR)
 - Multi-ACLR
 - Spurious Emissions
- Power vs. Time: Slot and Frame
- Modulation Analysis
 - Constellation
 - Data Channel
 - Control Channel
 - Subframe
 - Time Alignment Error
 - Data Allocation Map
- Auto Measure
 - Conformance Test
 - Maintenance Test
 - Signal Performance Test
 - DAS Test
- Power Statistics CCDF
- Carrier Aggregation

- Over The Air (OTA)
 - Channel Scanner
 - ID Scanner
 - Multipath Profile
 - Control Channel
 - Datagram
 - Route Map

Display overview

Figure 103 provides descriptions for each segment of the measurement screen.

Figure 103 LTE - TDD signal analyzer measurement screen

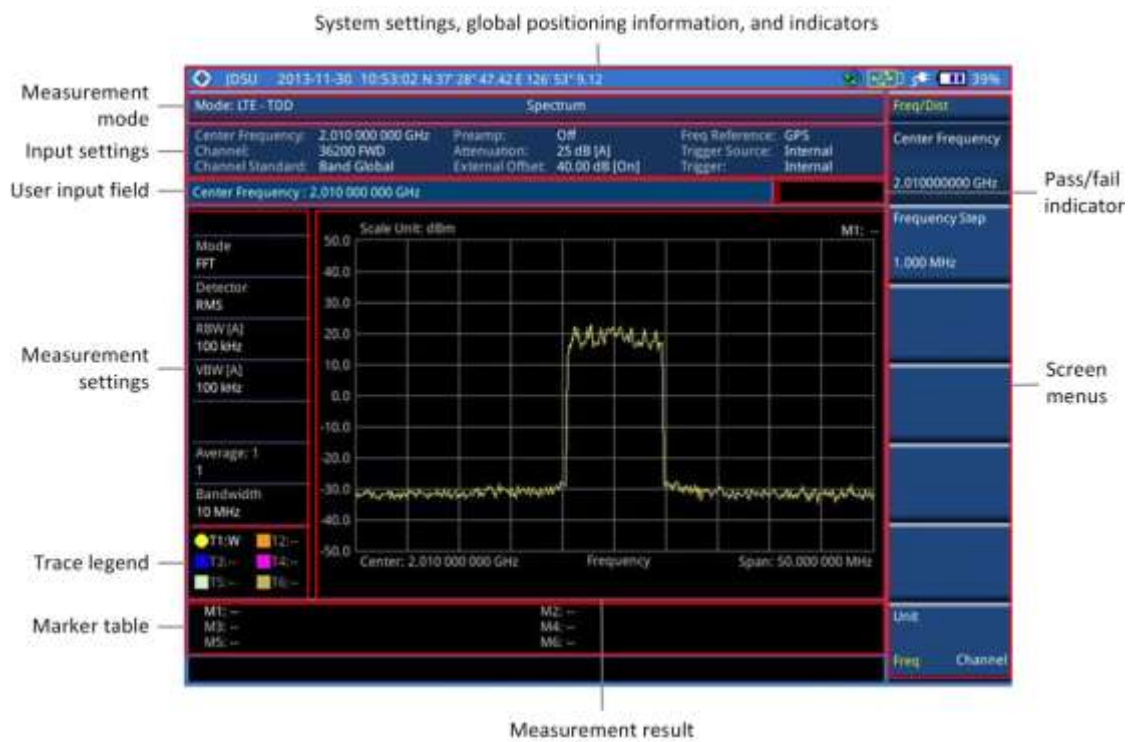

Connecting a cable

Direct connection

Procedure

1. Connect the **Spectrum Analyzer RF In** port of the JD780A series and the Power amplifier output port of BTS.

Figure 104 Direct connection

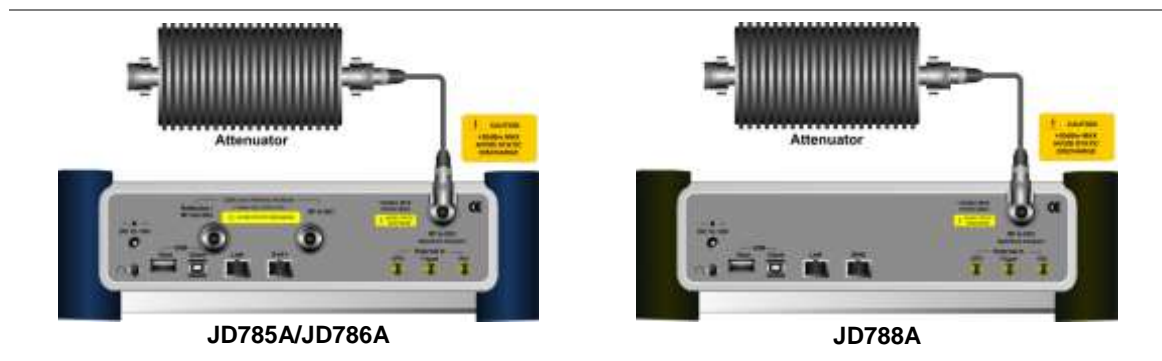

Indirect connection

Procedure

1. Connect the **Spectrum Analyzer RF In** port of the JD780A series and the monitor (test) port of BTS.

Figure 105 Indirect connection

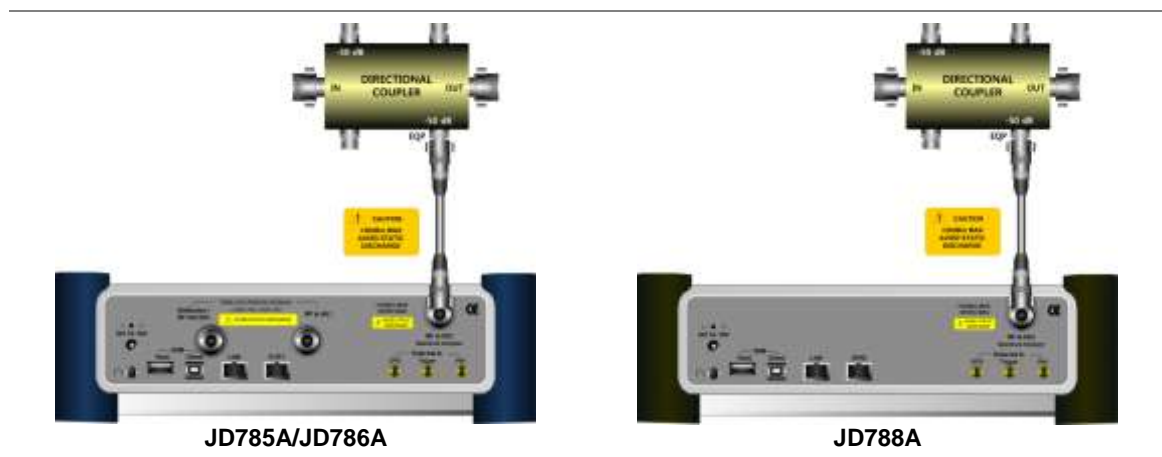

CAUTION

The maximum power for the **Spectrum Analyzer RF In** port is +25 dBm (0.316 W). If the input signal level to be measured is greater than +25 dBm, use a **High Power Attenuator** to prevent damage when you directly connect the signal to the instrument or connect the signal from the coupling port of a directional coupler.

Over the air (OTA)

Procedure

1. Connect an Omni/directional RF antenna to the **Spectrum Analyzer RF In** port of the JD780A series.
2. Connect a GPS antenna to the **GPS** port of the JD780A series.

Figure 106 OTA connection

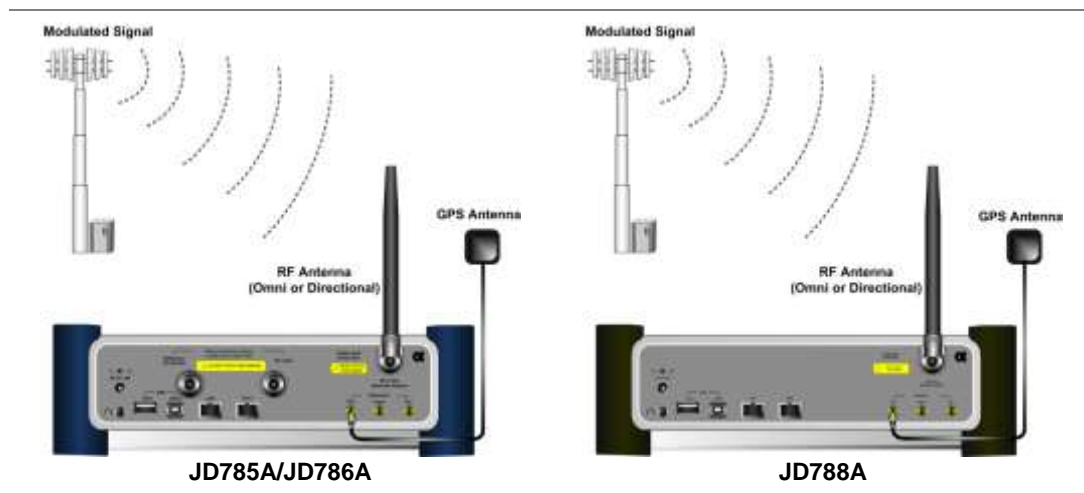

CAUTION

If the input signal level to be measured is less than 0 dBm, set 0 dB attenuation or turn on the preamp to have better dynamic range for the OTA testing.

Selecting measurement mode

Procedure

1. Press the **MODE** hard key.
2. Press the **Signal Analyzer** soft key.
3. Press the **LTE - TDD** soft key. The **Spectrum** mode is set by default.
4. Press the **MEASURE** hot key, and then select the measurement mode option from the following choices:
 - Spectrum
 - RF Analysis > Channel Power, Occupied BW, Spectrum Emission Mask, ACLR, Multi-ACLR, or Spurious Emissions
 - Power vs Time > Power vs Time (Slot) or Power vs Time (Frame)
 - Modulation Analysis > Constellation, Data Channel, Control Channel, Subframe, Time Alignment Error, or Data Allocation Map
 - Auto Measure > Conformance Test, Maintenance Test, Signal Performance, or DAS Test
 - Power Statistics CCDF
 - More (1/2) > Carrier Aggregation
 - More (1/2) > OTA > Channel Scanner, ID Scanner, Multipath Profile, Control Channel, Datagram, or Route Map

NOTE

The **Carrier Aggregation** soft key is activated if the license for the option 031 LTE-Advanced TDD is installed.

Configuring test parameters

Setting frequency

You can set the frequency with either frequency or channel number. If a frequency to be set matches to the frequency corresponding to the selected channel standard, the instrument calculates its channel number and updates the screen with it automatically.

Procedure

To set the center frequency:

1. Press the **FREQ/DIST** hard key.
2. Toggle the **Unit** soft key and select **Freq**.
3. Press the **Center Frequency** soft key.
4. Enter a value by using the numeric keys. You can also use the rotary knob.
5. Select the unit: **GHz**, **MHz**, **kHz**, or **Hz**.
6. *Optional.* To define the amount of frequency increment for the rotary knob, complete the following steps:
 - a. Press the **Frequency Step** soft key.
 - b. Enter a value by using the numeric keys. You can also use the rotary knob.
 - c. Press the unit: **GHz**, **MHz**, **kHz**, or **Hz**.

To set the channel number:

1. Press the **FREQ/DIST** hard key.
2. Toggle the **Unit** soft key and select **Channel**.

NOTE

Selecting **Channel** sets the standard channel to **Band Global** automatically so that you can set the **Channel Number** without choosing a standard channel band from the list.

3. Press the **Channel Number** soft key.
4. Enter a value by using the numeric keys. You can also use the rotary knob.
5. Press the **Enter** soft key.

The instrument automatically displays the corresponding center frequency value for the selected channel number.

6. *Optional.* To define the amount of channel increment for the rotary knob, complete the following steps:
 - a. Press the **Channel Step** soft key.
 - b. Enter a value by using the numeric keys. You can also use the rotary knob.
 - c. Press the **Enter** soft key.

NOTE

This frequency setting is not used in the Multi-ACLR and Spurious Emissions modes.

Setting amplitude

Reference level and attenuation

You can set the reference and attenuation levels automatically or manually to optimize the display of the traces measured, as you desire.

Procedure

To automatically set the reference and attenuation level:

1. Press the **AMP/SCALE** hard key.
2. Press the **Auto Scale** soft key.
Each time you press this key, both of the Y-axis scale and input attenuation level change to be optimized with some margin.

To set the reference or attenuation level manually:

1. Press the **AMP/SCALE** hard key.
2. To set the maximum reference value on the Y-axis manually, complete the following steps:
 - a. Press the **Reference Level** soft key.
 - b. Enter a value by using the numeric keys or the rotary knob with 10 dB increments.
 - c. Press the **dBm** soft key or the **ENTER** hard key.

NOTE

In the measurements such as **Control Channel**, and **Subframe**, you may need to select the reference option between **Relative** and **Absolute** before setting the reference level.

3. To set the attenuation option, select one from the following choices:
 - To set the input attenuator's level automatically, select **Attenuation > Auto**.

NOTE

It is recommended that you set the **Attenuation to Auto** in most situations so that the level of the input attenuator can be set automatically according to your input signal level.

- To set the input attenuation manually up to 55 dB to optimize S/N, complete the following steps:
 - a. Select **Attenuation > Manual**.
 - b. Press the **Attenuation Value** soft key to set the level.
 - c. Enter a value between 0 and 55 in fives by using the numeric keys.
 - d. Press the **dB** soft key or the **ENTER** hard key.
- To couple the input attenuator's level with your reference level setting, select **Attenuation > Couple**.
As you increase the reference setting, the attenuation level also increases accordingly.

Optional. To change the scale unit:

1. Select **More (1/2) > Units**.
2. Select the unit of the display scale: **dBm**, **dBV**, **dBmV**, **dBμV**, **V**, or **W**.
The scale unit on the screen changes accordingly.

NOTE

This Units menu is available in the Spectrum and RF Analysis modes.

Scale per division

You can use the **Scale/Div** feature available for the spectrum and RF analysis. It represents the value of one division on the horizontal scale. The default setting is 10 dB per division and the maximum value can be set up to 20 dB.

Procedure

To set the scale per division:

1. Press the **AMP/SCALE** hard key.
 2. Select **More (1/2) > Scale/Div**.
 3. Enter a value between 1 and 20 by using the numeric keys.
 4. Press the **dB** soft key to complete the entry.
-

Pre-amplifier

You can turn the internal pre-amplifier on to correct and compensate for the gain of the preamp so that amplitude readings show the value at the input connector.

Procedure

1. Press the **AMP/SCALE** hard key.
 2. Toggle the **Preamp** soft key and select **On** or **Off** as needed.
-

NOTE

You can turn the Preamp on when the input attenuation range is from 0 dB to 10 dB. If the attenuation value is manually set to greater than 10 dB, the instrument will automatically turn off the pre-amplifier to display low-level signal properly on the chart.

External offset

You can turn the **External Offset** on and manually set the external offset value. An offset consists of a cable loss and a user offset and the measurement result shows the value reflecting both offset values. When the external offset value is set at 40 dB in the Spectrum mode, the measurement result compensates 40 dB at both the Spectrum Analyzer and Signal Analyzer modes

Procedure

To set the external offset:

1. Press the **AMP/SCALE** hard key.
2. Toggle the **External Offset** soft key and select **On**.
3. Enter a value by using the numeric keys.
4. Press the **dB** soft key to complete the entry.

To turn the external offset off:

1. Press the **AMP/SCALE** hard key.
 2. Toggle the **External Offset** soft key and select **Off**.
-

Setting average

You can set the number of measurements to be averaged for the trace presentation. A maximum of 100 times of averaging can be set. When the averaging reaches to your setting, a new measurement value replaces the measurement value in sequence from the earliest.

Procedure

1. Press the **BW/AVG** hard key.
 2. Press the **Average** soft key.
 3. Enter a value between 1 and 100 as needed by using the numeric keys.
 4. Press the **Enter** soft key.
-

Setting sweep mode

The default settings of the sweep mode are **Continue** and **Normal** to sweep continuously at a normal speed for most on-going measurements. If you want to hold the measurement or get a single sweep, you can change the sweep mode.

Procedure

To select the single sweep mode:

1. Press the **SWEEP** hot key.
2. Toggle the **Sweep Mode** soft key and select **Single**. You can also use the **HOLD** hot key. The letter **HOLD** in red appears and the sweeping is paused.
3. *Optional.* Press the **Sweep Once** soft key to get a new measurement.

To return to the continuous sweep mode:

1. Toggle the **Sweep Mode** soft key and select **Continue**. You can also use the **HOLD** hot key. The letter **HOLD** in red disappears and the sweeping resumes.
-

Setting trigger source

You can set the trigger source option for your measurements.

Procedure

1. Press the **TRIGGER** hot key.
 2. Select the trigger source option from the following choices: **Internal**, **External**, or **GPS**.
-

Setting external clock

To enhance the reliability of modulation analysis measurements the JD780A series must be synchronized with a base station. When an external clock is not supplied, the instrument works with its built-in internal high-accuracy time base and some measurement results may exhibit inaccurate values. Therefore, it is highly recommended that you use the same reference clock as the signal source. You can use the **TRIGGER** hot key to set the external clock.







Figure 107 Connection ports for external reference clock



Procedure

1. Connect an external reference or a GPS antenna to the JD780A series.
 2. Press the **SYSTEM** hot key.
 3. Press the **Freq Reference** soft key, and then select the reference option: **Internal**, **External 10 MHz**, **External 13 MHz**, **External 15 MHz**, or **GPS**.
-

Table 15 External reference indicators

Type	Indicator	Description
Internal	 (green)	The green INT icon indicates that the instrument uses the built-in internal time base.
External	 (green)	The green EXT icon indicates that an external reference is connected and locked and that the instrument uses the same reference clock as the signal source.
External	 (red)	The red EXT icon indicates that an external reference is connect but not locked.
GPS	 (green)	The green GPS antenna icon indicates that a GPS antenna is connected and locked.
GPS	 (yellow)	The yellow GPS antenna icon indicates that a GPS antenna is connected and locking is in progress.
GPS	 (grey)	The grey GPS antenna icon indicates that a GPS antenna is not connected, failed, or unable to be locked.

Conducting spectrum measurements

Setting measure setup

After configuring test parameters as described in the “Configuring test parameters” on page 242, you can continue your measurement.

Procedure

1. Press the **MEASURE SETUP** hot key.
 2. To set the nominal channel bandwidth to be measured, complete the following steps:
 - a. Press the **Bandwidth** soft key.
 - b. Select the bandwidth option: **1.4 MHz**, **3 MHz**, **5 MHz**, **10 MHz**, **15 MHz**, or **20 MHz**.
 3. To select the subframe number to be measured, complete the following steps:
 - a. Press the **Subframe No** soft key.
 - b. Enter a value by using the numeric keys. You can also use the rotary knob.
 - c. Press the **Enter** soft key.
 4. Toggle the **Cell ID** soft key and select **Auto** or **Manual** as desired:
 - **Auto**: to let the instrument detect the Cell ID for the LTE signal automatically.
 - **Manual**: to set a specific Cell ID for the LTE signal manually in order to speed up the synchronization with a BTS.
-

Your measurement result is displayed on the screen as like the following example, Figure 108.

Figure 108 Spectrum measurement screen with LTE - TDD signal analyzer



Setting trace

You can display up to six traces on the measurement chart simultaneously.

Procedure

1. Press the **TRACE/DISPLAY** hard key.
2. Press the **Select Trace** soft key, and then select the trace number: **T1**, **T2**, **T3**, **T4**, **T5**, or **T6**. The legend shape of the selected trace changes from square to round to indicate that the trace is the active one now.
3. Toggle the **Trace View** soft key and select **On**.
4. To clear, write or capture, or hide the trace(s), do one of the following:

To	Select	Trace Legend
Clear current data and display with new measurements	Clear Write	W
Display the input signal's maximum response only	Max Hold	M
Display the input signal's minimum response only	Min Hold	m
Capture the selected trace and compare traces	Capture	C
Load a saved trace	More (1/2) > Load	L
Hide the selected trace	Trace View > Off	F
Remove all the traces and initialize the trace settings	More (1/2) > Trace Clear All	

5. *Optional.* Press the **More (1/2) > Trace Info** soft key, and then select the trace number to view the trace's parameter setting information stored at the time of the measurement or **None** to hide the information display.
6. *Optional.* If you have the two traces T1 and T2, you can perform trace math. To view the power difference between the traces, press the **T1 - T2 -> T5** or **T2 - T1 -> T6** soft key. The result is overlaid on the screen along with the second Y-axis.

Conducting RF measurements

Channel power

The Channel Power measurement is a common test used in the wireless industry to measure the total transmitted power of a radio within a defined frequency channel. It acquires a number of points representing the input signal in the time domain, transforms this information into the frequency domain using Fast Fourier Transform (FFT), and then calculates the channel power. The effective resolution bandwidth of the frequency domain trace is proportional to the number of points acquired for the FFT.

The channel power measurement identifies the total RF power and power spectral density (PSD) of the signal in the LTE channel bandwidth.

Setting measure setup

After configuring test parameters as described in the “Configuring test parameters” on page 242, you can continue your measurement.

Procedure

1. Press the **MEASURE SETUP** hot key.
 2. To set the nominal channel bandwidth to be measured, complete the following steps:
 - a. Press the **Bandwidth** soft key.
 - b. Select the bandwidth option: **1.4 MHz, 3 MHz, 5 MHz, 10 MHz, 15 MHz, or 20 MHz**.
 3. To select the subframe number to be measured, complete the following steps:
 - a. Press the **Subframe No** soft key.
 - b. Enter a value by using the numeric keys. You can also use the rotary knob.
 - c. Press the **Enter** soft key.
 4. Toggle the **Cell ID** soft key and select **Auto** or **Manual** as desired:
 - **Auto**: to let the instrument detect the Cell ID for the LTE signal automatically.
 - **Manual**: to set a specific Cell ID for the LTE signal manually in order to speed up the synchronization with a BTS.
-

Measurement example

Figure 109 Channel power measurement with LTE - TDD signal analyzer



NOTE

You can use the **LIMIT** hot key to analyze your measurements with the user-definable limit and Pass/Fail indication. See “Setting limit for RF tests” on page 257 for more information.

Occupied bandwidth

The Occupied Bandwidth measures the spectrum shape of the carrier. It is defined as the bandwidth, which includes 99% of the transmitted power among total transmitted power.

Setting measure setup

After configuring test parameters as described in the “Configuring test parameters” on page 242, you can continue your measurement.

Procedure

1. Press the **MEASURE SETUP** hot key.
2. To set the nominal channel bandwidth to be measured, complete the following steps:
 - a. Press the **Bandwidth** soft key.
 - b. Select the bandwidth option: **1.4 MHz**, **3 MHz**, **5 MHz**, **10 MHz**, **15 MHz**, or **20 MHz**.
3. To select the subframe number to be measured, complete the following steps:
 - a. Press the **Subframe No** soft key.
 - b. Enter a value by using the numeric keys. You can also use the rotary knob.
 - c. Press the **Enter** soft key.
4. Toggle the **Cell ID** soft key and select **Auto** or **Manual** as desired:
 - **Auto**: to let the instrument detect the Cell ID for the LTE signal automatically.
 - **Manual**: to set a specific Cell ID for the LTE signal manually in order to speed up the synchronization with a BTS.

Measurement example

Figure 110 Occupied bandwidth measurement with LTE - TDD signal analyzer



NOTE

You can use the **LIMIT** hot key to analyze your measurements with the user-definable limit and Pass/Fail indication. See “Setting limit for RF tests” on page 257 for more information.

Spectrum emission mask (SEM)

The Spectrum Emission Mask (SEM) measurement required by 3GPP specifications encompasses different power limits and different measurement bandwidths (resolution bandwidths) at various frequency offsets. It may be expressed as a ratio of power spectral densities between the carrier and the specified offset frequency band. It provides useful figures-of-merit for the spectral re-growth and emissions produced by components and circuit blocks, without the rigor of performing a full SEM measurement.

The SEM measures spurious signal levels in up to five pairs of offset or region frequencies and relates them to the carrier power.

Setting measure setup

After configuring test parameters as described in the “Configuring test parameters” on page 242, you can continue your measurement.

Procedure

1. Press the **MEASURE SETUP** hot key.
2. To set the nominal channel bandwidth to be measured, complete the following steps:
 - a. Press the **Bandwidth** soft key.
 - b. Select the bandwidth option: **1.4 MHz, 3 MHz, 5 MHz, 10 MHz, 15 MHz, or 20 MHz.**
3. To select the mask type, complete the following steps:

- a. Press the **Mask Type** soft key.
- b. Select the mask type option, from the following choices:
 - **Wide Area BS Category A**
 - **Wide Area BS Category B**
 - **Local Area BS**
 - **Home BS**
4. To select the subframe number to be measured, complete the following steps:
 - a. Press the **Subframe No** soft key.
 - b. Enter a value by using the numeric keys. You can also use the rotary knob.
 - c. Press the **Enter** soft key.
5. Toggle the **Cell ID** soft key and select **Auto** or **Manual** as desired:
 - **Auto**: to let the instrument detect the Cell ID for the LTE signal automatically.
 - **Manual**: to set a specific Cell ID for the LTE signal manually in order to speed up the synchronization with a BTS.

Measurement example

Figure 111 SEM measurement with LTE - TDD signal analyzer



NOTE
 You can use the **LIMIT** hot key to analyze your measurements with the user-definable limit and Pass/Fail indication. See “Setting limit for RF tests” on page 257 for more information.

ACLR

The Adjacent Channel Leakage power Ratio (ACLR) measures the amount of interference or power in an adjacent frequency channel according to the standards.

Setting measure setup

After configuring test parameters as described in the “Configuring test parameters” on page 242, you

can continue your measurement.

Procedure

1. Press the **MEASURE SETUP** hot key.
 2. To set the nominal channel bandwidth to be measured, complete the following steps:
 - a. Press the **Bandwidth** soft key.
 - b. Select the bandwidth option: **1.4 MHz, 3 MHz, 5 MHz, 10 MHz, 15 MHz, or 20 MHz**.
 3. To select the subframe number to be measured, complete the following steps:
 - a. Press the **Subframe No** soft key.
 - b. Enter a value by using the numeric keys. You can also use the rotary knob.
 - c. Press the **Enter** soft key.
 4. Toggle the **Cell ID** soft key and select **Auto** or **Manual** as desired:
 - **Auto**: to let the instrument detect the Cell ID for the LTE signal automatically.
 - **Manual**: to set a specific Cell ID for the LTE signal manually in order to speed up the synchronization with a BTS.
-

Measurement example

Figure 112 ACLR measurement with LTE - TDD signal analyzer



NOTE

You can use the **LIMIT** hot key to analyze your measurements with the user-definable limit and Pass/Fail indication. See “Setting limit for RF tests” on page 257 for more information.

Multi-ACLR

The Multi-ACLR measurement is used to perform multi-channel ACLR measurements with as many channels as possible. It helps you to measure ACLR in multi-channel transmitting Base Station environment.

Setting measure setup

After configuring test parameters as described in the “Configuring test parameters” on page 242, you can continue your measurement.

Procedure

1. Press the **MEASURE SETUP** hot key.
2. To set the nominal channel bandwidth to be measured, complete the following steps:
 - a. Press the **Bandwidth** soft key.
 - b. Select the bandwidth option: **1.4 MHz**, **3 MHz**, **5 MHz**, **10 MHz**, **15 MHz**, or **20 MHz**.
3. To set the frequency, do one of the following:
 - To set the center frequency, complete the following steps:
 - a. Toggle the **Unit** soft key and select **Freq**.
 - b. Press the **Lowest Frequency** soft key to set the starting center frequency.
 - c. Enter a value by using the numeric keys. You can also use the rotary knob.
 - d. Select the unit: **GHz**, **MHz**, **kHz**, or **Hz**.
 - e. Press the **Highest Frequency** soft key to set the stopping center frequency.
 - f. Enter a value by using the numeric keys. You can also use the rotary knob.
 - g. Select the unit: **GHz**, **MHz**, **kHz**, or **Hz**.
 - To set the channel number, complete the following steps:
 - a. Toggle the **Unit** soft key and select **Channel**.

NOTE

Selecting **Channel** sets the standard channel to **Band Global** automatically so that you can set the **Channel Number** without choosing a standard channel band from the list.

- b. Press the **Lowest Channel** soft key to set the starting channel.
 - c. Enter a value by using the numeric keys. You can also use the rotary knob.
 - d. Press the **Enter** soft key.
 - e. Press the **Highest Channel** soft key to set the stopping channel.
 - f. Enter a value by using the numeric keys. You can also use the rotary knob.
 - g. Press the **Enter** soft key.
-

Measurement example

Figure 113 Multi-ACLR measurement with LTE - TDD signal analyzer



NOTE

You can use the **LIMIT** hot key to analyze your measurements with the user-definable limit and Pass/Fail indication. See “Setting limit for RF tests” on page 257 for more information.

Spurious emissions

Out-of-band emissions are unwanted emissions immediately outside the channel bandwidth resulting from the modulation process and non-linearity in the transmitter but excluding spurious emissions. The Spurious Emissions measurement is to identify and determine the power level of out-of-band spurious emission within the necessary channel bandwidth and modulated signal measured at the RF port of the Base Station.

Setting measure setup

After configuring test parameters as described in the “Configuring test parameters” on page 242, you can continue your measurement.

Procedure

1. Press the **MEASURE SETUP** hot key.
2. To set up the range table and frequency range, press the **Range Table** soft key and then complete the following steps:
 - a. Press the **Range** soft key, and then enter the range number to add a new range or change an existing one.
 - b. Press the **Enter** soft key.
 - c. Press the **Start Frequency** soft key to set up the frequency range.
 - d. Enter a value by using the numeric keys. You can also use the rotary knob.
 - e. Select the unit: **GHz**, **MHz**, **kHz**, or **Hz**.
 - f. Press the **Stop Frequency** soft key to set up the frequency range.

- g. Enter a value by using the numeric keys. You can also use the rotary knob.
 - h. Select the unit: **GHz**, **MHz**, **kHz**, or **Hz**.
3. Toggle the **Range** soft key between **On** and **Off** to display or hide the selected range.
 4. To set up the test limits for Pass/Fail indication, complete the following steps:
 - a. Press the **Start Limit** soft key.
 - b. Enter a value by using the numeric keys. You can also use the rotary knob.
 - c. Select the **dBm** soft key.
 - d. Press the **Stop Limit** soft key.
 - e. Enter a value by using the numeric keys. You can also use the rotary knob.
 - f. Select the **dBm** soft key.
 5. To set up the other parameters, complete the following steps:
 - a. Select **More (1/2) > Attenuation** to set up the attenuation value.
 - b. Enter a value in the multiple of five.
 - c. Press the **dB** soft key or the **ENTER** hard key.
 - d. Press the **RBW** soft key.
 - e. Enter a value by using the numeric keys.
 - f. Select the unit: **GHz**, **MHz**, **kHz**, or **Hz**.
 - g. Press the **VBW** soft key.
 - h. Enter a value by using the numeric keys.
 - i. Select the unit: **GHz**, **MHz**, **kHz**, or **Hz**.
 6. Press the **PREV** hard key.
 7. Toggle the **Measure Type** soft key between **Examine** and **Full** to select the measurement type.

NOTE

The **Examine** mode displays only the selected range while the **Full** mode lets the instrument automatically changes the selected range from one another.

8. Set the number of measurements to be averaged:
 - a. Press the **Average** soft key.
 - b. Enter a value between 1 and 100.
 - c. Press the **Enter** soft key.
-

Measurement example

Figure 114 Spurious emissions measurement with LTE - TDD signal analyzer



NOTE

You can use the **LIMIT** hot key to analyze your measurements with the user-definable limit and Pass/Fail indication. See “Setting limit for RF tests” on page 257 for more information.

Setting limit for RF tests

By default, test limits specified in the standard are set for you. You can change thresholds if you desire.

Procedure

1. Press the **LIMIT** hot key.
2. Press the **RF Test Limits** soft key.
3. Select the test item(s) and set the limit(s) depending on your selected measurement mode:

To set the limit for	Select	Set
Channel power	Channel Power	High Limit Low Limit
Occupied bandwidth	Occupied BW	High Limit
Spectrum emission mask	Spectrum Emission Mask	(On/Off only)
ACLR	ACLR	(On/Off only)
Multi-ACLR	Multi-ACLR	(On/Off only)
Spurious emissions	Spurious Emissions	(On/Off only)

4. *Optional.* You can enable alarm sound that goes off if the measurement falls outside of the limit. Toggle the **Beep** soft key between **On** and **Off** to enable or disable the beep sound.
5. *Optional.* Go to **SAVE/LOAD > Save**, and then select **Limit** to save the limit settings. See “Using save” on page 31 for more information.

Conducting power vs. time measurements

The Power vs. Time measurement measures the modulation envelope in the time domain, showing the signal rise and fall shape of LTE signal and the power of each time slot in an LTE signal.

Power vs. time (slot)

The Power vs. Time (Slot) in LTE - TDD Signal Analyzer measures the modulation envelope in the time domain, showing the signal rise and fall shape of LTE signal.

Setting measure setup

After configuring test parameters as described in the “Configuring test parameters” on page 242, you can continue your measurement. The measurement settings can be saved and recalled as a file.

Procedure

1. Press the **MEASURE SETUP** hot key.
 2. To set the nominal channel bandwidth to be measured, complete the following steps:
 - a. Press the **Bandwidth** soft key.
 - b. Select the bandwidth option: **1.4 MHz**, **3 MHz**, **5 MHz**, **10 MHz**, **15 MHz**, or **20 MHz**.
 3. To select the slot number to be measured, complete the following steps:
 - a. Press the **Slot No** soft key.
 - b. Enter a value by using the numeric keys. You can also use the rotary knob.
 - c. Press the **Enter** soft key.
 4. Toggle the **Cell ID** soft key and select **Auto** or **Manual** as desired:
 - **Auto**: to let the instrument detect the Cell ID for the LTE signal automatically.
 - **Manual**: to set a specific Cell ID for the LTE signal manually in order to speed up the synchronization with a BTS.
 5. *Optional.* Press the **Miscellaneous** soft key, and then do the following(s) as needed:
 - To select the number of antenna ports, toggle the **MIMO** soft key and select **2x2** or **4x4**. This MIMO (Multiple Input Multiple Output) setting is activated only if the option 031 LTE-Advanced TDD is installed with a license number. If not, the instrument sets this option to 2x2 by default. A 2x1 or 4x1 RF combiner is also required to be able to test on MIMO channels.
 - To assign a antenna port number automatically or manually, press the **Antenna Port** soft key and select the option: **Auto**, **0**, **1**, **2**, and **3**. If the option 031 LTE-Advanced TDD is not installed or if the MIMO is set to 2x2, the antenna ports 2 and 3 are disabled.
 - To select the cyclic prefix, toggle the **Cyclic Prefix** soft key and select **Normal** or **Extended**. See “Appendix E – Cyclic prefix table” on page 545 for OFDM parameter details by different bandwidth.
 - To set the delay, complete the following steps:
 - a. Press the **Delay** soft key to set the amount of delay in μs .
 - b. Enter a value by using the numeric keys. You can also use the rotary knob.
 - c. Press the **μs** soft key.
-

NOTE

The Delay setting is used only when there is a time offset in the signals to be measured.

Setting limit for power vs. time tests

Procedure

1. Press the **LIMIT** hot key.
2. Press the **PvsT Test Limits** soft key.
3. Select the test item(s) and set the limit(s):

To set the limit for	Select	Set
Slot average power	Slot Avg Power	High Limit, Low Limit
Off power	Off Power	High Limit
Transition period	Transition Period	High Limit

4. *Optional.* You can enable alarm sound that goes off if the measurement falls outside of the limit. Toggle the **Beep** soft key between **On** and **Off** to enable or disable the beep sound.
5. *Optional.* Go to **SAVE/LOAD > Save**, and then select **Limit** to save the limit settings. See “Using save” on page 31 for more information.

Measurement example

Figure 115 Power vs. time (slot) measurement with LTE – TDD signal analyzer

- 1) Off to on



2) On to off



Power vs. time (frame)

The Power vs. Time (Frame) measures the modulation envelope in the time domain, showing the power of each time slot in an LTE signal.

Setting measure setup

After configuring test parameters as described in the “Configuring test parameters” on page 242, you can continue your measurement. The measurement settings can be saved and recalled as a file.

Procedure

1. Press the **MEASURE SETUP** hot key.
2. To set the nominal channel bandwidth to be measured, complete the following steps:
 - a. Press the **Bandwidth** soft key.
 - b. Select the bandwidth option: **1.4 MHz**, **3 MHz**, **5 MHz**, **10 MHz**, **15 MHz**, or **20 MHz**.
3. To select the subframe number to be measured, complete the following steps:
 - a. Press the **Subframe No** soft key.
 - b. Enter a value by using the numeric keys. You can also use the rotary knob.
 - c. Press the **Enter** soft key.
4. Toggle the **Cell ID** soft key and select **Auto** or **Manual** as desired:
 - **Auto**: to let the instrument detect the Cell ID for the LTE signal automatically.
 - **Manual**: to set a specific Cell ID for the LTE signal manually in order to speed up the synchronization with a BTS.
5. *Optional.* Press the **Miscellaneous** soft key, and then do the following(s) as needed:
 - To select the number of antenna ports, toggle the **MIMO** soft key and select **2x2** or **4x4**. This MIMO (Multiple Input Multiple Output) setting is activated only if the option 031 LTE-Advanced TDD is installed with a license number. If not, the instrument sets this option to 2x2 by default. A 2x1 or 4x1 RF combiner is also required to able to test on MIMO channels.
 - To assign a antenna port number automatically or manually, press the **Antenna Port** soft

key and select the option: **Auto, 0, 1, 2, and 3**. If the option 031 LTE-Advanced TDD is not installed or if the MIMO is set to 2x2, the antenna ports 2 and 3 are disabled.

- To select the cyclic prefix, toggle the **Cyclic Prefix** soft key and select **Normal** or **Extended**. See “Appendix E – Cyclic prefix table” on page 545 for OFDM parameter details by different bandwidth.
- To set the delay, complete the following steps:
 - a. Press the **Delay** soft key to set the amount of delay in μs .
 - b. Enter a value by using the numeric keys. You can also use the rotary knob.
 - c. Press the **μs** soft key.

NOTE

The Delay setting is used only when there is a time offset in the signals to be measured.

Measurement example

Figure 116 Power vs. time (frame) measurement with LTE – TDD signal analyzer



Conducting modulation measurements

Constellation

The Constellation is used to observe some aspects of modulation accuracy and can reveal certain fault mechanisms such as I/Q amplitude imbalance or quadrature imbalance. It displays constellation diagram by modulation types.

Setting measure setup

After configuring test parameters as described in the “Configuring test parameters” on page 242, you can continue your measurement. The measurement settings can be saved and recalled as a file. You can also use JDViewer, PC application software to configure a measure setup, save as a file, and load the file on to the instrument.

Procedure

1. Press the **MEASURE SETUP** hot key.
2. To set the nominal channel bandwidth to be measured, complete the following steps:
 - a. Press the **Bandwidth** soft key.
 - b. Select the bandwidth option: **1.4 MHz**, **3 MHz**, **5 MHz**, **10 MHz**, **15 MHz**, or **20 MHz**.
3. To select the subframe number to be measured, complete the following steps:
 - a. Press the **Subframe No** soft key.
 - b. Enter a value by using the numeric keys. You can also use the rotary knob.

NOTE

For MBMS testing, this subframe number must be neither 0 nor 5 as these subframes 0 and 5 are not available for MBMS and it must be set to the MBMS transmitted channel's subframe number.

- c. Press the **Enter** soft key.
4. *Optional.* Toggle the **Cell ID** soft key and select **Auto** or **Manual** as desired:
 - **Auto**: to let the instrument detect the Cell ID for the LTE signal automatically.
 - **Manual**: to set a specific Cell ID for the LTE signal manually in order to speed up the synchronization with a BTS.
5. *Optional.* Toggle the **CFI** soft key and select **Auto** or **Manual** as desired:
 - **Auto**: to let the instrument set the number of OFDM symbols used for transmitting PDCCHs in a subframe.
 - **Manual**: to set the number of OFDM symbols manually. The set of OFDM symbols that can be used for PDCCH in a subframe is given by **0**, **2**, **3** or **4** in 1.4 MHz bandwidth and **1**, **2**, or **3** in other bandwidths.
6. *Optional.* Press the **PHICH Ng** soft key, and then select the option for the number of PHICH groups (Ng): **1/6**, **1/2**, **1**, **2**, **E-1/6**, **E-1/2**, **E-1**, or **E-2**.
7. Press the **Uplink-Downlink Configuration** soft key, and then select the number of uplink/downlink between one and six.
8. *Optional.* Press the **Miscellaneous** soft key, and then do the following(s) as needed:
 - To select the number of antenna ports, toggle the **MIMO** soft key and select **2x2** or **4x4**. This MIMO (Multiple Input Multiple Output) setting is activated only if the option 031 LTE-Advanced TDD is installed with a license number. If not, the instrument sets this option to 2x2 by default. A 2x1 or 4x1 RF combiner is also required to able to test on MIMO channels.
 - To assign a antenna port number automatically or manually, press the **Antenna Port** soft key and select the option: **Auto**, **0**, **1**, **2**, and **3**. If the option 031 LTE-Advanced TDD is not installed or if the MIMO is set to 2x2, the antenna ports 2 and 3 are disabled.
 - To turn the Multimedia Broadcast Multicast Service (MBMS) feature on or off, toggle the **MBMS** soft key and select **On** or **Off**. For proper MBMS testing, you need to set the **Subframe No** with the same PMCH subframe number. If this setting is on, either PMCH or PDSCH appears on the screen depending on the detected channel.
 - To set the Multicast Broadcast Single Frequency Network (MBSFN) detection automatically or manually for MBMS testing, toggle the **MBSFN** soft key and select **Auto** or **Manual**. An automatically detected or manually entered MBSFN ID appears on the screen.
 - To set the delay, complete the following steps:
 - a. Press the **Delay** soft key to set the amount of delay in μ s.
 - b. Enter a value by using the numeric keys. You can also use the rotary knob.
 - c. Press the **μ s** soft key.

NOTE

The Delay setting is used only when there is a time offset in the signals to be measured.

- To select the cyclic prefix, toggle the **Cyclic Prefix** soft key and select **Normal** or **Extended**. See “Appendix E – Cyclic prefix table” on page 545 for OFDM parameter details by different bandwidth.
- Press the **PDSCH Modulation Type** soft key, and then select the modulation type option: **Auto**, **QPSK**, **16 QAM**, **64 QAM**, **E-TM3.3**, **E-TM3.2**, **E-TM3.1**, **E-TM2**, **E-TM1.2**, and **E-TM1.1**. If two or more modulation types are used in a frame, select **Auto**. If the PDSCH uses the same modulation type in a frame or in a subframe, select a specific modulation type to get more accurate EVM.
- To set the threshold for PDSCH, complete the following steps:
 - a. Press the **PDSCH Threshold** soft key.
 - b. Enter a value by using the numeric keys.
 - c. Press the **dB** soft key.
- Toggle the **PDSCH Precoding** soft key between **On** and **Off** to enable or disable the PDSCH precoding.

Measurement example**Figure 117** Constellation measurement with LTE - TDD signal analyzer

Figure 118 Constellation measurement with LTE - TDD signal analyzer (MBMS On)



NOTE

You can use the **LIMIT** hot key to analyze your measurements with the user-definable limit and Pass/Fail indication. See “Setting limit for modulation tests” on page 277 for more information.

Data channel

The Data Channel measures the constellation for the specified resource block as well as the modulation accuracy of each PDSCH at the specified subframe.

Setting measure setup

After configuring test parameters as described in the “Configuring test parameters” on page 242, you can continue your measurement. The measurement settings can be saved and recalled as a file. You can also use JDViewer, PC application software to configure a measure setup, save as a file, and load the file on to the instrument.

Procedure

1. Press the **MEASURE SETUP** hot key.
2. To set the nominal channel bandwidth to be measured, complete the following steps:
 - a. Press the **Bandwidth** soft key.
 - b. Select the bandwidth option: **1.4 MHz, 3 MHz, 5 MHz, 10 MHz, 15 MHz, or 20 MHz.**
3. To select the subframe number to be measured, complete the following steps:
 - a. Press the **Subframe No** soft key.
 - b. Enter a value by using the numeric keys. You can also use the rotary knob.

NOTE

For MBMS testing, this subframe number must be neither 0 nor 5 as these subframes 0 and 5 are not available for MBMS and it must be set to the MBMS transmitted channel’s subframe number.

- c. Press the **Enter** soft key.

4. *Optional.* Toggle the **Cell ID** soft key and select **Auto** or **Manual** as desired:
 - **Auto:** to let the instrument detect the Cell ID for the LTE signal automatically.
 - **Manual:** to set a specific Cell ID for the LTE signal manually in order to speed up the synchronization with a BTS.
5. *Optional.* Toggle the **CFI** soft key and select **Auto** or **Manual** as desired:
 - **Auto:** to let the instrument set the number of OFDM symbols used for transmitting PDCCHs in a subframe.
 - **Manual:** to set the number of OFDM symbols manually. The set of OFDM symbols that can be used for PDCCH in a subframe is given by **0, 2, 3** or **4** in 1.4 MHz bandwidth and **1, 2,** or **3** in other bandwidths.
6. *Optional.* Press the **PHICH Ng** soft key, and then select the option for the number of PHICH groups (Ng): **1/6, 1/2, 1, 2, E-1/6, E-1/2, E-1,** or **E-2.**
7. Toggle the **Event Hold** soft key between **On** and **Off** to enable or disable the event hold feature. When enabled, the display line for the PDSCH threshold appears. When an event occurs, the measurement is put on hold until you press the **HOLD** hot key.

NOTE

You can view detailed current resource block on the I-Q diagram, particularly in a dynamic field environment.

8. Press the **More (1/2) > Uplink-Downlink Configuration** soft key, and then select the number of uplink/downlink between one and six.
9. *Optional.* Press the **More (1/2) > Miscellaneous** soft key, and then do the following(s) as needed:
 - To select the number of antenna ports, toggle the **MIMO** soft key and select **2x2** or **4x4**. This MIMO (Multiple Input Multiple Output) setting is activated only if the option 031 LTE-Advanced TDD is installed with a license number. If not, the instrument sets this option to 2x2 by default. A 2x1 or 4x1 RF combiner is also required to able to test on MIMO channels.
 - To assign a antenna port number automatically or manually, press the **Antenna Port** soft key and select the option: **Auto, 0, 1, 2,** and **3**. If the option 031 LTE-Advanced TDD is not installed or if the MIMO is set to 2x2, the antenna ports 2 and 3 are disabled.
 - To turn the Multimedia Broadcast Multicast Service (MBMS) feature on or off, toggle the **MBMS** soft key and select **On** or **Off**. For proper MBMS testing, you need to set the **Subframe No** with the same PMCH subframe number. If this setting is on, either PMCH or PDSCH appears on the screen depending on the detected channel.
 - To set the Multicast Broadcast Single Frequency Network (MBSFN) detection automatically or manually for MBMS testing, toggle the **MBSFN** soft key and select **Auto** or **Manual**. An automatically detected or manually entered MBSFN ID appears on the screen.
 - To set the delay, complete the following steps:
 - a. Press the **Delay** soft key to set the amount of delay in μs .
 - b. Enter a value by using the numeric keys. You can also use the rotary knob.
 - c. Press the **μs** soft key.

NOTE

The Delay setting is used only when there is a time offset in the signals to be measured.

- To select the cyclic prefix, toggle the **Cyclic Prefix** soft key and select **Normal** or **Extended**. See “Appendix E – Cyclic prefix table” on page 545 for OFDM parameter details by different bandwidth.
- Press the **PDSCH Modulation Type** soft key, and then select the modulation type option: **Auto, QPSK, 16 QAM, 64 QAM, E-TM3.3, E-TM3.2, E-TM3.1, E-TM2, E-TM1.2,** and **E-TM1.1**. If two or more modulation types are used in a frame, select **Auto**. If the PDSCH uses the same modulation type in a frame or in a subframe, select a specific modulation

- type to get more accurate EVM.
- To set the threshold for PDSCH, complete the following steps:
 - a. Press the **PDSCH Threshold** soft key.
 - b. Enter a value by using the numeric keys.
 - c. Press the **dB** soft key.
- Toggle the **PDSCH Precoding** soft key between **On** and **Off** to enable or disable the PDSCH precoding.

Measurement example

Figure 119 Data channel measurement with LTE - TDD signal analyzer



Figure 120 Data channel measurement with LTE - TDD signal analyzer (MBMS On)



NOTE

You can use the **LIMIT** hot key to analyze your measurements with the user-definable limit and Pass/Fail indication. See “Setting limit for modulation tests” on page 277 for more information.

Using marker

You can use the **MARKER** hard key to place a marker on a resource block and display the IQ diagram for the selected resource block.

Procedure

1. Press the **MARKER** hard key.
2. Press the **RB Number** soft key to select the resource block to be marked.
3. Enter the resource block number by using the numeric keys.
4. Press the **Enter** soft key.
The marker appears on the selected resource block.
5. Toggle the **Marker View** soft key between **On** and **Off** to display or dismiss the result of the selected resource block.

Control channel

The Control Channel measures the constellation for the specified control channel as well as modulation accuracy of the control channel at the specified subframe.

Setting measure setup

After configuring test parameters as described in the “Configuring test parameters” on page 242, you can continue your measurement. The measurement settings can be saved and recalled as a file. You can also use JDViewer, PC application software to configure a measure setup, save as a file, and load the file on to the instrument.

Procedure

1. Press the **MEASURE SETUP** hot key.
2. To set the nominal channel bandwidth to be measured, complete the following steps:
 - a. Press the **Bandwidth** soft key.
 - b. Select the bandwidth option: **1.4 MHz**, **3 MHz**, **5 MHz**, **10 MHz**, **15 MHz**, or **20 MHz**.
3. To select the subframe number to be measured, complete the following steps:
 - a. Press the **Subframe No** soft key.
 - b. Enter a value by using the numeric keys. You can also use the rotary knob.

NOTE

For MBMS testing, this subframe number must be neither 0 nor 5 as these subframes 0 and 5 are not available for MBMS and it must be set to the MBMS transmitted channel's subframe number.

- c. Press the **Enter** soft key.
4. *Optional.* Toggle the **Cell ID** soft key and select **Auto** or **Manual** as desired:
 - **Auto**: to let the instrument detect the Cell ID for the LTE signal automatically.

- **Manual:** to set a specific Cell ID for the LTE signal manually in order to speed up the synchronization with a BTS.
5. *Optional.* Toggle the **CFI** soft key and select **Auto** or **Manual** as desired:
 - **Auto:** to let the instrument set the number of OFDM symbols used for transmitting PDCCHs in a subframe.
 - **Manual:** to set the number of OFDM symbols manually. The set of OFDM symbols that can be used for PDCCH in a subframe is given by **0, 2, 3** or **4** in 1.4 MHz bandwidth and **1, 2,** or **3** in other bandwidths.
 6. *Optional.* Press the **PHICH Ng** soft key, and then select the option for the number of PHICH groups (Ng): **1/6, 1/2, 1, 2, E-1/6, E-1/2, E-1,** or **E-2.**
 7. Toggle the **EVM Detection Mode** soft key and select **Single** or **Combine** as desired:
 - **Single:** Testing on one single antenna connected to your JD780A series with a cable.
 - **Combine:** Testing on multiple antennas connected to your JD780A series with a 2x1 or 4x1 combiner or an antenna.
 8. Press the **Uplink-Downlink Configuration** soft key, and then select the number of uplink/downlink between one and six.
 9. *Optional.* Press the **Miscellaneous** soft key, and then do the following(s) as needed:
 - To select the number of antenna ports, toggle the **MIMO** soft key and select **2x2** or **4x4**. This MIMO (Multiple Input Multiple Output) setting is activated only if the option 031 LTE-Advanced TDD is installed with a license number. If not, the instrument sets this option to 2x2 by default. A 2x1 or 4x1 RF combiner is also required to able to test on MIMO channels.
 - To assign a antenna port number automatically or manually, press the **Antenna Port** soft key and select the option: **Auto, 0, 1, 2,** and **3**. If the option 031 LTE-Advanced TDD is not installed or if the MIMO is set to 2x2, the antenna ports 2 and 3 are disabled.
 - To turn the Multimedia Broadcast Multicast Service (MBMS) feature on or off, toggle the **MBMS** soft key and select **On** or **Off**. For proper MBMS testing, you need to set the **Subframe No** with the same PMCH subframe number. If this setting is on, the measurement item “MBSFN RS” appears in the result table.
 - To set the Multicast Broadcast Single Frequency Network (MBSFN) detection automatically or manually for MBMS testing, toggle the **MBSFN** soft key and select **Auto** or **Manual**. An automatically detected or manually entered MBSFN ID appears on the screen.
 - To set the delay, complete the following steps:
 - a. Press the **Delay** soft key to set the amount of delay in μ s.
 - b. Enter a value by using the numeric keys. You can also use the rotary knob.
 - c. Press the **μ s** soft key.

NOTE

The Delay setting is used only when there is a time offset in the signals to be measured.

- To select the cyclic prefix, toggle the **Cyclic Prefix** soft key and select **Normal** or **Extended**. See “Appendix E – Cyclic prefix table” on page 545 for OFDM parameter details by different bandwidth.
- To set the threshold for PDCCH, complete the following steps:
 - a. Press the **PDCCH Threshold** soft key.
 - b. Enter a value by using the numeric keys.
 - c. Press the **dB** soft key.
- Toggle the **PDCCH Mode** soft key and select **REG** to calculate EVM based on Resource Element Group or **Avg** to calculate EVM after adding up all the PDCCH signals from one subframe.

Measurement example

Figure 121 Control channel measurement with LTE - TDD signal analyzer



Figure 122 Control channel measurement with LTE - TDD signal analyzer (MBMS On)



NOTE
 You can use the **LIMIT** hot key to analyze your measurements with the user-definable limit and Pass/Fail indication. See “Setting limit for modulation tests” on page 277 for more information.

Using marker

You can use the **MARKER** hard key to place a marker on a resource block and display the IQ diagram for the selected resource block.

Procedure

1. Press the **MARKER** hard key.

2. Press the **Channel** soft key to select the channel to be displayed in the IQ diagram. The channel P-SS is selected by default.
3. Turn the rotary knob to move the highlight from one to another in the channel summary table.
4. Toggle the **Marker View** soft key between **On** and **Off** to display or dismiss the result of the selected channel.

Subframe

The Subframe measures the modulation accuracy of all the data and control channels at the specified subframe (1 ms).

Setting measure setup

After configuring test parameters as described in the “Configuring test parameters” on page 242, you can continue your measurement. The measurement settings can be saved and recalled as a file. You can also use JDViewer, PC application software to configure a measure setup, save as a file, and load the file on to the instrument.

Procedure

1. Press the **MEASURE SETUP** hot key.
2. To set the nominal channel bandwidth to be measured, complete the following steps:
 - a. Press the **Bandwidth** soft key.
 - b. Select the bandwidth option: **1.4 MHz, 3 MHz, 5 MHz, 10 MHz, 15 MHz, or 20 MHz**.
3. To select the subframe number to be measured, complete the following steps:
 - a. Press the **Subframe No** soft key.
 - b. Enter a value by using the numeric keys. You can also use the rotary knob.

NOTE

For MBMS testing, this subframe number must be neither 0 nor 5 as these subframes 0 and 5 are not available for MBMS and it must be set to the MBMS transmitted channel's subframe number.

- c. Press the **Enter** soft key.
4. *Optional.* Toggle the **Cell ID** soft key and select **Auto** or **Manual** as desired:
 - **Auto:** to let the instrument detect the Cell ID for the LTE signal automatically.
 - **Manual:** to set a specific Cell ID for the LTE signal manually in order to speed up the synchronization with a BTS.
5. *Optional.* Toggle the **CFI** soft key and select **Auto** or **Manual** as desired:
 - **Auto:** to let the instrument set the number of OFDM symbols used for transmitting PDCCHs in a subframe.
 - **Manual:** to set the number of OFDM symbols manually. The set of OFDM symbols that can be used for PDCCH in a subframe is given by **0, 2, 3 or 4** in 1.4 MHz bandwidth and **1, 2, or 3** in other bandwidths.
6. *Optional.* Press the **PHICH Ng** soft key, and then select the option for the number of PHICH groups (Ng): **1/6, 1/2, 1, 2, E-1/6, E-1/2, E-1, or E-2**.
7. Toggle the **EVM Detection Mode** soft key and select **Single** or **Combine** as desired:
 - **Single:** Testing on one single antenna connected to your JD780A series with a cable.
 - **Combine:** Testing on multiple antennas connected to your JD780A series with a 2x1 or 4x1

combiner or an antenna.

8. Press the **Uplink-Downlink Configuration** soft key, and then select the number of uplink/downlink between one and six.
9. *Optional.* Press the **Miscellaneous** soft key, and then do the following(s) as needed:
 - To select the number of antenna ports, toggle the **MIMO** soft key and select **2x2** or **4x4**. This MIMO (Multiple Input Multiple Output) setting is activated only if the option 031 LTE-Advanced TDD is installed with a license number. If not, the instrument sets this option to 2x2 by default. A 2x1 or 4x1 RF combiner is also required to be able to test on MIMO channels.
 - To assign an antenna port number automatically or manually, press the **Antenna Port** soft key and select the option: **Auto**, **0**, **1**, **2**, and **3**. If the option 031 LTE-Advanced TDD is not installed or if the MIMO is set to 2x2, the antenna ports 2 and 3 are disabled.
 - To turn the Multimedia Broadcast Multicast Service (MBMS) feature on or off, toggle the **MBMS** soft key and select **On** or **Off**. For proper MBMS testing, you need to set the **Subframe No** with the same PMCH subframe number. If this setting is on, the measurement item “MBSFN RS” appears in the result table and either PMCH or PDSCH appears as well depending on the detected channel.
 - To set the Multicast Broadcast Single Frequency Network (MBSFN) detection automatically or manually for MBMS testing, toggle the **MBSFN** soft key and select **Auto** or **Manual**. An automatically detected or manually entered MBSFN ID appears on the screen.
 - To set the delay, complete the following steps:
 - a. Press the **Delay** soft key to set the amount of delay in μs .
 - b. Enter a value by using the numeric keys. You can also use the rotary knob.
 - c. Press the **μs** soft key.

NOTE

The Delay setting is used only when there is a time offset in the signals to be measured.

- To select the cyclic prefix, toggle the **Cyclic Prefix** soft key and select **Normal** or **Extended**. See “Appendix E – Cyclic prefix table” on page 545 for OFDM parameter details by different bandwidth.
 - Press the **PDSCH Modulation Type** soft key, and then select the modulation type option: **Auto**, **QPSK**, **16 QAM**, **64 QAM**, **E-TM3.3**, **E-TM3.2**, **E-TM3.1**, **E-TM2**, **E-TM1.2**, and **E-TM1.1**. If two or more modulation types are used in a frame, select **Auto**. If the PDSCH uses the same modulation type in a frame or in a subframe, select a specific modulation type to get more accurate EVM.
 - To set the threshold for PDSCH, complete the following steps:
 - a. Press the **PDSCH Threshold** soft key.
 - b. Enter a value by using the numeric keys.
 - c. Press the **dB** soft key.
 - To set the threshold for PDCCH, complete the following steps:
 - a. Press the **PDCCH Threshold** soft key.
 - b. Enter a value by using the numeric keys.
 - c. Press the **dB** soft key.
 - Toggle the **PDCCH Mode** soft key and select **REG** to calculate EVM based on Resource Element Group or **Avg** to calculate EVM after adding up all the PDCCH signals from one subframe.
 - Toggle the **PDSCH Precoding** soft key between **On** and **Off** to enable or disable the PDSCH precoding.
-

Measurement example

Figure 123 Subframe measurement with LTE - TDD signal analyzer

1) Regular view



2) Chart view



Figure 124 Subframe measurement with LTE - TDD signal analyzer (MBMS On)

**NOTE**

You can use the **LIMIT** hot key to analyze your measurements with the user-definable limit and Pass/Fail indication. See “Setting limit for modulation tests” on page 277 for more information.

Setting display

You can use the **TRACE/DISPLAY** hard key to view your measurement result with the chart.

Procedure

1. Press the **TRACE/DISPLAY** hard key.
2. Toggle the **Chart** soft key between **On** and **Off** to display or dismiss the chart. If this setting is on, the **MARKER** hard key is activated.

Using marker

If you turn the Chart view on, you can use the **MARKER** hard key to place the marker at a specific symbol.

Procedure

1. Press the **MARKER** hard key.
2. Toggle the **Marker View** soft key between **On** and **Off** to display or dismiss the marker on the chart.
3. Press the **Symbol** soft key to select the symbol number, to which the marker is placed.
4. Enter a value by using the numeric keys.
5. Press the **Enter** soft key.

Time alignment error

In eNode B supporting Tx Diversity transmission, signals are transmitted from two or more antennas.

These signals shall be aligned. The time alignment error in Tx diversity is specified as the delay between the signals from two antennas at the antenna ports.

Setting measure setup

After configuring test parameters as described in the “Configuring test parameters” on page 242, you can continue your measurement. The measurement settings can be saved and recalled as a file. You can also use JDViewer, PC application software to configure a measure setup, save as a file, and load the file on to the instrument.

Procedure

1. Press the **MEASURE SETUP** hot key.
2. To set the nominal channel bandwidth to be measured, complete the following steps:
 - a. Press the **Bandwidth** soft key.
 - b. Select the bandwidth option: **1.4 MHz**, **3 MHz**, **5 MHz**, **10 MHz**, **15 MHz**, or **20 MHz**.
3. *Optional.* Toggle the **Cell ID** soft key and select **Auto** or **Manual** as desired:
 - **Auto**: to let the instrument detect the Cell ID for the LTE signal automatically.
 - **Manual**: to set a specific Cell ID for the LTE signal manually in order to speed up the synchronization with a BTS.
4. *Optional.* Press the **Miscellaneous** soft key, and then do the following(s) as needed:
 - To select the number of antenna ports, toggle the **MIMO** soft key and select **2x2** or **4x4**. This MIMO (Multiple Input Multiple Output) setting is activated only if the option 031 LTE-Advanced TDD is installed with a license number. If not, the instrument sets this option to 2x2 by default. A 2x1 or 4x1 RF combiner is also required to able to test on MIMO channels.
 - To assign a antenna port number automatically or manually, press the **Antenna Port** soft key and select the option: **Auto**, **0**, **1**, **2**, and **3**. If the option 031 LTE-Advanced TDD is not installed or if the MIMO is set to 2x2, the antenna ports 2 and 3 are disabled.
 - To set the delay, complete the following steps:
 - a. Press the **Delay** soft key to set the amount of delay in μs .
 - b. Enter a value by using the numeric keys. You can also use the rotary knob.
 - c. Press the **μs** soft key.

NOTE

The Delay setting is used only when there is a time offset in the signals to be measured.

- To select the cyclic prefix, toggle the **Cyclic Prefix** soft key and select **Normal** or **Extended**. See “Appendix E – Cyclic prefix table” on page 545 for OFDM parameter details by different bandwidth.
-

Measurement example

Figure 125 Time alignment error measurement with LTE - TDD signal analyzer



NOTE

You can use the **LIMIT** hot key to analyze your measurements with the user-definable limit and Pass/Fail indication. See “Setting limit for modulation tests” on page 277 for more information.

Data allocation map

The Data Allocation Map function represents data allocation as a mapping.

Setting measure setup

After configuring test parameters as described in the “Configuring test parameters” on page 242, you can continue your measurement. The measurement settings can be saved and recalled as a file. You can also use JDViewer, PC application software to configure a measure setup, save as a file, and load the file on to the instrument.

Procedure

1. Press the **MEASURE SETUP** hot key.
2. To set the nominal channel bandwidth to be measured, complete the following steps:
 - a. Press the **Bandwidth** soft key.
 - b. Select the bandwidth option: **1.4 MHz**, **3 MHz**, **5 MHz**, **10 MHz**, **15 MHz**, or **20 MHz**.
3. To select the subframe number to be measured, complete the following steps:
 - a. Press the **Subframe No** soft key.
 - b. Enter a value by using the numeric keys. You can also use the rotary knob.

NOTE

For MBMS testing, this subframe number must be neither 0 nor 5 as these subframes 0 and 5 are not available for MBMS and it must be set to the MBMS transmitted channel's subframe number.

- c. Press the **Enter** soft key.

4. To set the threshold for PDSCH, complete the following steps:
 - a. Press the **PDSCH Threshold** soft key.
 - b. Enter a value by using the numeric keys.
 - c. Press the **dB** soft key.
5. *Optional.* Toggle the **Cell ID** soft key and select **Auto** or **Manual** as desired:
 - **Auto:** to let the instrument detect the Cell ID for the LTE signal automatically.
 - **Manual:** to set a specific Cell ID for the LTE signal manually in order to speed up the synchronization with a BTS.
6. *Optional.* Press the **Miscellaneous** soft key, and then do the following(s) as needed:
 - To select the number of antenna ports, toggle the **MIMO** soft key and select **2x2** or **4x4**. This MIMO (Multiple Input Multiple Output) setting is activated only if the option 031 LTE-Advanced TDD is installed with a license number. If not, the instrument sets this option to 2x2 by default. A 2x1 or 4x1 RF combiner is also required to be able to test on MIMO channels.
 - To assign a antenna port number automatically or manually, press the **Antenna Port** soft key and select the option: **Auto**, **0**, **1**, **2**, and **3**. If the option 031 LTE-Advanced TDD is not installed or if the MIMO is set to 2x2, the antenna ports 2 and 3 are disabled.
 - To turn the Multimedia Broadcast Multicast Service (MBMS) feature on or off, toggle the **MBMS** soft key and select **On** or **Off**. For proper MBMS testing, you need to set the **Subframe No** with the same PMCH subframe number. If this setting is on, either PMCH or PDSCH appears on the screen depending on the detected channel.
 - To set the Multicast Broadcast Single Frequency Network (MBSFN) detection automatically or manually for MBMS testing, toggle the **MBSFN** soft key and select **Auto** or **Manual**. An automatically detected or manually entered MBSFN ID appears on the screen.
 - To select the cyclic prefix, toggle the **Cyclic Prefix** soft key and select **Normal** or **Extended**. See “Appendix E – Cyclic prefix table” on page 545 for OFDM parameter details by different bandwidth.

Measurement example

Figure 126 Data allocation map measurement with LTE - TDD signal analyzer



Figure 127 Data allocation map measurement with LTE - TDD signal analyzer (MBMS On)

**NOTE**

You can use the **LIMIT** hot key to analyze your measurements with the user-definable limit and Pass/Fail indication. See “Setting limit for modulation tests” on page 277 for more information.

Using marker

You can use the **MARKER** hard key to place the marker at a specific resource block and subframe.

Procedure

1. Press the **MARKER** hard key.
2. Toggle the **Marker View** soft key between **On** and **Off** to display or dismiss the marker on the chart.
3. To select the resource block number, complete the following steps:
 - a. Press the **RB Number** soft key.
 - b. Enter the resource block number to select by using the numeric keys. You can also use the rotary knob to move the marker side by side.
 - c. Press the **Enter** soft key.
4. To select the subframe block number, complete the following steps:
 - a. Press the **Subframe No** soft key.
 - b. Enter the subframe number to select by using the numeric keys. You can also use the rotary knob to move the marker up and down.
 - c. Press the **Enter** soft key.

Setting limit for modulation tests**Procedure**

1. Press the **LIMIT** hot key.
2. Press the **Modulation Test Limits** soft key to set the limits.

3. Select the test item(s) and set the limit(s) depending on your selected measurement mode:

To set the limit for	Select	Set
Frequency error	Frequency Error	High Limit Low Limit
PDSCH error vector magnitude if MBMS is off	EVM > PDSCH EVM	High Limit (QPSK) High Limit (16 QAM) High Limit (64 QAM)
PMCH error vector magnitude if MBMS is on and a PMCH is detected	EVM > PMCH EVM	High Limit (QPSK) High Limit (16 QAM) High Limit (64 QAM)
RMS for data error vector magnitude	EVM > Data EVM RMS	High Limit
Peak for data error vector magnitude	EVM > Data EVM Peak	High Limit
RS error vector magnitude	EVM > RS EVM	High Limit
P-SS error vector magnitude	EVM > P-SS EVM	High Limit
S-SS error vector magnitude	EVM > S-SS EVM	High Limit
Downlink RS power	Power > DL RS Power	High Limit Low Limit
P-SS power	Power > P-SS Power	High Limit Low Limit
S-SS power	Power > S-SS Power	High Limit Low Limit
PBCH power	Power > PBCH Power	High Limit Low Limit
Subframe power	Power > Subframe Power	High Limit Low Limit
OFDM symbol power	Power > OFDM Symbol Power	High Limit Low Limit
Time alignment error for MIMO	Time Alignment Error > MIMO	High Limit
Time alignment error for aggregation of component carriers (intra-band contiguous, intra-band non-contiguous, and inter-band)	Time Alignment Error > Carrier Aggregation	Intra Cont Intra Non-cont Inter Band
Time error	Time Error	High Limit Low Limit
I-Q origin offset	IQ Origin Offset	High Limit

4. *Optional.* You can enable alarm sound that goes off if the measurement falls outside of the limit. Toggle the **Beep** soft key between **On** and **Off** to enable or disable the beep sound.
5. *Optional.* Go to **SAVE/LOAD > Save**, and then select **Limit** to save the limit settings. See “Using save” on page 31 for more information.

Performing auto measurements

Conformance test

The Conformance Test is to test if eNode-B meets some specified standards that have been developed for verification. Its test procedure and test setups have been developed by 3GPP. Test results can be saved as a .CSV file type.

Setting limit for conformance test

You can set test limits for test item(s) in the auto measurement. Turning the test limit on for a test item makes the test item included in the conformance test.

Procedure

1. Press the **LIMIT** hot key.
2. To set the limit for BTS output power, complete the following steps:
 - a. Press the **BTS Output Power** soft key.
 - b. Toggle the **Test Limits** soft key between **On** and **Off** to enable or disable the limit.
 - c. Press the **High Limit** soft key.
 - d. Enter a value for the upper limit.
 - e. Press the **dBm** unit soft key.
 - f. Press the **Low Limit** soft key.
 - g. Enter a value for the lower limit.
 - h. Press the **dBm** unit soft key.
3. To set the limit for total power dynamic, complete the following steps:
 - a. Press the **Total Power Dynamic** soft key.
 - b. Toggle the **Test Limits** soft key between **On** and **Off** to enable or disable the limit.
 - c. Press the **Low Limit** soft key.
 - d. Enter a value for the lower limit.
 - e. Press the **dBm** unit soft key.
4. To set the limit for on/off power, press the **On/Off Power** soft key, and then do the following as needed:

To set the limit for	Select	Set
Off power	Off Power	High Limit
Transition period	Transition Period	High Limit

5. To verify signal quality, press the **Signal Quality** soft key, and then do the following as needed:

To set the limit for	Select	Set
Frequency error	Frequency Error	High Limit Low Limit
Error vector magnitude	EVM	High Limit (QPSK) High Limit (16 QAM) High Limit (64 QAM)
Time alignment error	Time Alignment Error	High Limit

RS power	RS Power	High Limit Low Limit
----------	----------	-------------------------

- To verify unwanted emissions, press the **Unwanted Emissions** soft key, and then do the following as needed:

To set the limit for	Select	Set
Occupied bandwidth	Occupied BW	High Limit
Adjacent channel power ratio	ACLR	
Spectrum emission mask	SEM	Mask Type
Spurious emissions	Spurious Emissions	Range Table

- Optional.* You can enable alarm sound that goes off if the measurement falls outside of the limit. Toggle the **Beep** soft key between **On** and **Off** to enable or disable the beep sound.
- Optional.* Go to **SAVE/LOAD > Save**, and then select **Limit** to save the limit settings. See “Using save” on page 31 for more information.

Setting measure setup

After setting frequency as described in the “Configuring test parameters” on page 242, you can continue your measurement.

Procedure

- Press the **MEASURE SETUP** hot key.
- Press the **Bandwidth** soft key.
- Select the nominal channel bandwidth to be measured, from the following choices:
 - **1.4 MHz, 3 MHz, 5 MHz, 10 MHz, 15 MHz, and 20 MHz**
- Press the **Sector** soft key, and then select the sector option: **Alpha, Beta, or Gamma**.
- To set external offset, complete the following steps:
 - Toggle the **External Offset** soft key and select **On**.
 - Enter a value by using the numeric keys.
 - Press the **dB** soft key.
- To save your settings and results, go to **SAVE/LOAD > Save** and then perform functions as you desire. See “Using save” on page 31 for more information.
- Press the **Run Test** soft key to start to run a test. The Auto Measure Results window appears at the end of the test.
- When prompted on the screen, connect the cable from the **Spectrum Analyzer RF In** port of the instrument either to **Antenna Port 0** or **Antenna Port 1** of the eNode-B, and then change the TM mode on the eNode-B side.
- Press the **Continue** soft key to continue testing.
- Repeat the steps 8-9 until completion of the test. A conformance test report appears at the end of the test.
- Optional.* To stop running the test, press the **Abort** soft key.

Maintenance test

The Auto Measure function of the JD780A series allows a complete signal profiling covering RF

characterization and modulation quality parameters of up to 20 different carriers, particularly useful on an overlay architecture where base stations are transmitting in different frequencies.

Following settings are required only when you run the Auto Measure Maintenance Test on the instrument using “Current” configuration setting. Additional settings are not required when you run Auto Measure using a scenario generated in the PC application software, JDViewer.

Setting limit for maintenance test

You can set test limits for test item(s) in the auto measurement.

Procedure

1. Press the **LIMIT** hot key.
 2. Press the **RF Test Limits** soft key, and then enable test limits as desired.
 3. Press the **PvsT Test Limits** soft key, and then enable test limits as desired.
 4. Press the **Modulation Test Limits** soft key, and then enable test limits as desired.
 5. *Optional.* You can enable alarm sound that goes off if the measurement falls outside of the limit. Toggle the **Beep** soft key between **On** and **Off** to enable or disable the beep sound.
 6. *Optional.* Go to **SAVE/LOAD > Save**, and then select **Limit** to save the limit settings. See “Using save” on page 31 for more information.
-

NOTE

You can use the **Allowed % Change** soft key for each test item to compare two measurement values displayed in the result table. This requires setting the **Display** mode to **Compare** in advance.

Setting measure setup

After configuring test parameters as described in the “Configuring test parameters” on page 242, you can continue your measurement. The measurement settings can be saved and recalled as a file. You can also use JDViewer, PC application software to configure a measure setup, save as a file, and load the file on to the instrument.

Procedure

1. Press the **MEASURE SETUP** hot key.
 2. Toggle the **Configuration** soft key and select the configuration option:
 - **Current**: to let the instrument use current frequency (single carrier) and determine pass or fail based on the instrument’s limit settings in Auto Measure.
 - **Scenario**: to run a test with a programmed scenario in JDViewer. The Scenario menu becomes activated.
 3. To load a scenario, press the **Scenario** soft key, and then select a scenario file to load.
 4. Toggle the **Test Time** soft key and select the test time option:
 - **Now**: to let the instrument run a test only once.
 - **Schedule**: to let the instrument repeat tests as defined in the Set Timing. The Set Timing menu becomes activated.
 5. To define a schedule for an auto measurement, complete the following steps:
 - a. Press the **Set Timing** soft key.
-

-
- b. Press the **Start Time (HH:MM)** soft key.
 - c. Enter the time in the HH:MM format, and then press the **Enter** soft key.
 - d. Press the **Stop Time (HH:MM)** soft key.
 - e. Enter the time in the HH:MM format, and then press the **Enter** soft key.
 - f. Press the **Time Interval** soft key.
 - g. Enter the amount of time in minutes, and then press the **Enter** soft key.
7. Press the **Settings** soft key, and then set the following:
 - a. Press the **Bandwidth** soft key, and then select the nominal channel bandwidth to be measured, from the following choices:
 - **1.4 MHz, 3 MHz, 5 MHz, 10 MHz, 15 MHz, and 20 MHz**
 - b. Toggle the **Cell ID** soft key and select **Auto** or **Manual** as desired:
 - **Auto**: to let the instrument detect the Cell ID for the LTE signal automatically.
 - **Manual**: to set a specific Cell ID for the LTE signal manually in order to speed up the synchronization with a BTS.
 - c. Press the **MIMO** soft key, and then select the antenna number option: **2x2** or **4x4**. This MIMO (Multiple Input Multiple Output) setting is activated only if the option 031 LTE-Advanced TDD is installed with a license number. If not, the instrument sets this option to 2x2 by default. A 2x1 or 4x1 RF combiner is also required to able to test on MIMO channels.
 - d. Press the **Antenna Port** soft key, and then select the option: **Auto, 0, 1, 2, or 3**. If the option 031 LTE-Advanced TDD is not installed or if the MIMO is set to 2x2, the antenna ports 2 and 3 are disabled.
 - e. Toggle the **External Offset** soft key and select **On**.
 - f. Enter a value by using the numeric keys, and then press the **dB** soft key.
 - g. To turn the Multimedia Broadcast Multicast Service (MBMS) feature on or off, toggle the **MBMS** soft key and select **On** or **Off**. For proper MBMS testing, you need to set the Subframe No with the same PMCH subframe number.
 - h. To set the Multicast Broadcast Single Frequency Network (MBSFN) detection automatically or manually for MBMS testing, toggle the **MBSFN** soft key and select **Auto** or **Manual**. An automatically detected or manually entered MBSFN ID appears on the screen.
 8. To save your settings and results, go to **SAVE/LOAD > Save** and then perform functions as you desire. See "Using save" on page 31 for more information.
 9. Press the **Run Test** soft key to start to run a test. The Auto Measure Results window appears at the end of the test.
 10. To stop running the test, press the **Abort** soft key.
 11. To change the view on the screen during the test, press the **Display** and then select the view option from the following choices:
 - **Screen**: You can view each measurement screen as the test progresses.
 - **Results**: You can view a measurement result table as the test progresses.
 - **Settings**: You can view a measurement setting table as the test progresses.
-

Setting display

After completion of the auto measurement, the screen menu changes to Trace/Display so that you can view the results in different forms.

Procedure

1. Toggle the **Display** soft key and select the display option:
 - **Result**: to view the result table. The Display Result menu becomes activated.
 - **Settings**: to view the measurement settings for the auto measurement.
 2. Toggle the **Display Result** soft key and select the display result option:
 - **Full**: to view detailed measurement readings with the pass/fail indication.
 - **Quick**: to view only the Pass/Fail results.
 - **Compare**: to compare two measurement values for each test time with the Allowed % Change setting on. You can view results vs. factory-defined or user-defined references.
 3. To view the measurement results for a different carrier, press the **View Carrier** soft key and then select the carrier number to view.
 4. Press the **Replace Reference** soft key to replace existing reference values for comparison with new measurement data.
 5. Press the **Load From** soft key to select the location from which references file to be loaded.
-

Signal performance test

Unlike the other auto measurement tests, the Signal Performance Test runs measurements continuously.

Setting limit for signal performance test

You can set test limits for test item(s) in the auto measurement.

Procedure

1. Press the **LIMIT** hot key.
 2. Press the **RF Test Limits > Channel Power** soft key, and then set the limits for the channel power. Other RF test items are not used in the signal performance test.
 3. Press the **Modulation Test Limits** soft key, and then enable test limits as desired.
 4. *Optional.* You can enable alarm sound that goes off if the measurement falls outside of the limit. Toggle the **Beep** soft key between **On** and **Off** to enable or disable the beep sound.
 5. *Optional.* Go to **SAVE/LOAD > Save**, and then select **Limit** to save the limit settings. See "Using save" on page 31 for more information.
-

Setting measure setup

After configuring test parameters as described in the "Configuring test parameters" on page 242, you can continue your measurement. The measurement settings can be saved and recalled as a file. You can also use JDViewer, PC application software to configure a measure setup, save as a file, and load the file on to the instrument.

Procedure

1. Press the **MEASURE SETUP** hot key.
 2. Toggle the **Cell ID** soft key and select **Auto** or **Manual** as desired:
 - **Auto**: to let the instrument detect the Cell ID for the LTE signal automatically.
-

-
- **Manual:** to set a specific Cell ID for the LTE signal manually in order to speed up the synchronization with a BTS.
3. Press the **MIMO** soft key, and then select the antenna number option: **2x2** or **4x4**. This MIMO (Multiple Input Multiple Output) setting is activated only if the option 031 LTE-Advanced TDD is installed with a license number. If not, the instrument sets this option to 2x2 by default. A 2x1 or 4x1 RF combiner is also required to able to test on MIMO channels.
 4. Press the **Antenna Port** soft key, and then select the option: **Auto, 0, 1, 2, or 3**. If the option 031 LTE-Advanced TDD is not installed or if the MIMO is set to 2x2, the antenna ports 2 and 3 are disabled.
 5. Press the **Bandwidth** soft key, and then select the nominal channel bandwidth to be measured, from the following choices:
 - **1.4 MHz, 3 MHz, 5 MHz, 10 MHz, 15 MHz, and 20 MHz**
 6. Toggle the **RF Profile** soft key between **On** and **Off** to turn on or off the RF profiling such as channel power and subframe frequency error.
 7. Toggle the **Modulation Profile** soft key between **On** and **Off** to turn on or off the modulation profiling such as P-SS, S-SS, Data - QPSK, Data – 16 QAM, and Data – 64 QAM.
 8. Toggle the **MIMO Profile** soft key between **On** and **Off** to turn on or off the MIMO profiling such as TX1 - RS0, TX2 - RS1, and time alignment error.
 9. Toggle the **External Offset** soft key and select **On** to set the external offset value.
 10. To save your settings and results, go to **SAVE/LOAD > Save** and then perform functions as you desire. See “Using save” on page 31 for more information.
-

DAS test

The Distributed Antenna System (DAS) testing enables you to check the degradation of performance in the signal transmission from a radio band to antennas distributed from it. You can save measurement values at both the radio band and antennas and then compare results with percentage of changes. You can also save test results in the .csv file format for ease of analysis.

Setting measure setup

Procedure

1. Press the **MEASURE SETUP** hot key.
 2. Press the **Settings** soft key and then set the following;
 - a. Press the **Bandwidth** soft key and then select the nominal channel bandwidth to be measured from the choices: **1.4 MHz, 3 MHz, 5 MHz, 10 MHz, 15 MHz, and 20 MHz**:
 - b. Press the **MIMO** soft key, and then select the antenna number option: **2x2** or **4x4**. This MIMO (Multiple Input Multiple Output) setting is activated only if the option 031 LTE-Advanced TDD is installed with a license number. If not, the instrument sets this option to 2x2 by default. A 2x1 or 4x1 RF combiner is also required to able to test on MIMO channels.
 - c. Toggle the **Cell ID** soft key and select **Auto** or **Manual** as desired:
 - **Auto:** to let the instrument detect the Cell ID for the LTE signal automatically.
 - **Manual:** to set a specific Cell ID for the LTE signal manually in order to speed up the synchronization with a BTS.
 - d. Press the **Antenna Port** soft key, and then select the option: **Auto, 0, 1, 2, or 3**. If the option 031 LTE-Advanced TDD is not installed or if the MIMO is set to 2x2, the antenna ports 2 and 3 are disabled.
 - e. Toggle the **External Offset** soft key and select **On** to set the external offset value.
-

-
- f. To turn the Multimedia Broadcast Multicast Service (MBMS) feature on or off, toggle the **MBMS** soft key and select **On** or **Off**.
 - g. To set the Multicast Broadcast Single Frequency Network (MBSFN) detection automatically or manually for MBMS testing, toggle the **MBSFN** soft key and select **Auto** or **Manual**. An automatically detected or manually entered MBSFN ID appears on the screen.
 3. To save your settings, go to **SAVE/LOAD > Save > Save Setup** and then perform functions as you desire. See "Using save" on page 31 for more information.
 4. Press the **Continue** soft key to do the reference test first or press the **Skip Reference Test** soft key if you already saved test results from the radio band under test.
 5. Press the **FREQ/DIST** hard key and then set the frequency to be measured. See "Setting frequency" on page 243 for more information.
 6. Press the **PREV** hard key.
 7. Press the **Limit** soft key and then set the limits and allowed percentage change for each test item. See "Maintenance test" on page 280 for more information on setting limits.
 8. Keep pressing the **PREV** hard key until you see the Run Test soft key.
 9. Press the **Run Test** soft key.
The instrument runs specified tests to gather reference measurement values. The measurement table appears when the reference test is done.
 10. Press the **Continue** soft key to run the testing on an antenna (Ant 1).
 11. *Optional.* To change the settings such as **External Offset**, press the **Settings** and then change the settings as needed.
 12. Press the **Continue** soft key.
The instrument runs the testing on Ant 1. The Ant 1 tab appears with the updated result table when the test is done.
 13. To run the testing on the next antenna (Ant 2), press the **Run Test** soft key and then repeat the steps 11-12. You can do the testing on up to 10 distributed antennas for one radio band.
 14. To view test results for each antenna, press the **Select Antenna** soft key and then select the antenna tab number to display on the screen.
 15. *Optional.* Press the **Delete Test** soft key to delete the selected antenna tab.
 16. *Optional.* Press the **Retest Reference** soft key to obtain reference measurement values again.
 17. *Optional.* To save your measurement results, go to **SAVE/LOAD > Save** and then perform functions as you desire. See "Using save" on page 31 for more information.
-

Measurement example

Figure 128 DAS measurement with LTE - TDD signal analyzer



Performing power statistics CCDF measurements

The Power Statistics Complementary Cumulative Distribution Function (CCDF) measurement characterizes the power statistics of the input signal. It provides PAR (Peak to Average power Ratio) versus different probabilities.

Setting measure setup

After configuring test parameters as described in the “Configuring test parameters” on page 242, you can continue your measurement. The measurement settings can be saved and recalled as a file. You can also use JDViewer, PC application software to configure a measure setup, save as a file, and load the file on to the instrument.

Procedure

1. Press the **MEASURE SETUP** hot key.
2. Press the **CCDF Length** soft key to set the length of the CCDF.
3. Enter a value between 1 and 100 by using the numeric keys. You can also use the rotary knob.
4. Press the **Enter** soft key.

Measurement example

Figure 129 CCDF measurement with LTE - TDD signal analyzer



Performing carrier aggregation measurements

Carrier aggregation enables a maximum of five multiple LTE carriers to be used together in order to provide high data rate required for LTE-Advanced. Component carriers to be aggregated can be intra-band contiguous, intra-band non-contiguous, or inter-band. The JD780A series provides carrier aggregation measurements supporting for all the different modes with carrier aggregation bands added to the channel standard. This functionality is activated if the license for the option 031 LTE-Advanced TDD is installed.

Setting measure setup

After configuring test parameters as described in the “Configuring test parameters” on page 242, you can continue your measurement. The measurement settings can be saved and recalled as a file. You can also use JDViewer, PC application software to configure a measure setup, save as a file, and load the file on to the instrument.

Procedure

1. Press the **MEASURE SETUP** hot key.
2. To configure parameters for up to 5 component carriers, complete the following steps:
 - a. Press the **CA Configuration** soft key.
The component carrier configuration window appears.
 - b. Press the **CA Range** soft key.
 - c. Enter the number of the component carrier to be set between 1 and 5.
 - d. Press the **Enter** soft key.
 - e. Toggle the **Turn On** soft key and then select **On** to set parameters and view the results for the selected component carrier on the screen or **Off** to turn it off.
 - f. Set the following parameters as needed:

- **Center Frequency, Channel, Bandwidth, Cell ID, CFI, PHICH Ng, Antenna Port, MBMS On/Off, Cyclic Prefix, and PDSCH Modulation Type**
 - g. To set more component carriers, repeat the steps **c-f**.
3. Press the **MEASURE SETUP** hot key again.
 4. Toggle the **EVM Detection Mode** soft key and select **Single** or **Combine** as desired:
 - **Single:** Testing on one single antenna connected to your JD780A series with a cable.
 - **Combine:** Testing on multiple antennas connected to your JD780A series with a 2x1 or 4x1 combiner or an antenna.
 5. To select the subframe number to be measured, do one of the following:
 - If the **EVM Detection Mode** is set to **Single**, press the **Subframe No** soft key and then set the subframe number.

NOTE

For MBMS testing, this subframe number must be neither 0 nor 5 as these subframes 0 and 5 are not available for MBMS and it must be set to the MBMS transmitted channel's subframe number.

- If the **EVM Detection Mode** is set to **Combine**, toggle the **Subframe No** soft key and then select **0** or **5**.
6. To set the threshold for PDSCH, complete the following steps:
 - a. Press the **PDSCH Threshold** soft key.
 - b. Enter a value by using the numeric keys.
 - c. Press the **dB** soft key.
 7. Toggle the **PDSCH Precoding** soft key between **On** and **Off** to enable or disable the PDSCH precoding.
 8. To select the number of antenna ports, toggle the **MIMO** soft key and select **2x2** or **4x4**. This MIMO (Multiple Input Multiple Output) setting is activated only if the option 031 LTE-Advanced TDD is installed with a license number. If not, the instrument sets this option to 2x2 by default. A 2x1 or 4x1 RF combiner is also required to able to test on MIMO channels.

Setting display

You can use the **TRACE/DISPLAY** hard key to select modulation analysis or spectrum analysis.

Procedure

1. Press the **TRACE/DISPLAY** hard key.
2. Toggle the **Display** soft key and select **MA** for modulation analysis or **SA** for spectrum analysis. The screen changes according to the selected option.

Measurement example

Figure 130 Carrier aggregation measurement with LTE - TDD signal analyzer (MA)



Figure 131 Carrier aggregation measurement with LTE - TDD signal analyzer (SA)



NOTE

You can use the **LIMIT** hot key to analyze your measurements with the user-definable limit and Pass/Fail indication. See “Setting limit for modulation tests” on page 277 for more information.

Using marker

You can use the **MARKER** hard key to place the marker at a specific channel.

Procedure

1. Press the **MARKER** hard key.

2. Toggle the **Marker View** soft key between **On** and **Off** to display or dismiss the marker.
3. Press the **Channel** soft key to select the channel to be displayed on the IQ diagram.
4. Use the rotary knob to move and select an item under EVM.

Conducting LTE - TDD OTA measurements

The TDD LTE Over The Air (OTA) measurement has Channel Scanner, ID Scanner, Multipath Profile, Datagram, and Control Channel screens. The ID Scanner displays key parameters such as RSRP, RSRQ, RS-SINR, and S-SS RSSI. The Multipath Profile enables you to determine RF environmental conditions of testing area. The OTA Control Channel provides summary of all control channels including RS power variation over time.

Channel scanner

The Channel Scanner is a radio receiver that can automatically tune or scan two or more discrete frequencies and multi-channels, indicating when it finds a signal on one of them and then continuing scanning when that frequency goes silent.

Setting channel/frequency

Procedure

To set the channels to be scanned:

1. Press the **FREQ/DIST** hard key.
2. Toggle the **Unit** soft key and select **Channel**.
3. Press the **Index** soft key, and then enter an index number between one and six by turning the rotary knob or using the numeric keys.
4. To select the standard channel, complete the following steps:
 - d. Press the **Channel Std** soft key. The standard channel window appears. See "Appendix C – Band, frequency & channel standard" on page 541 for more information.
 - e. Select the band to be measured by using the rotary knob, the arrow keys, or the **Page Up/Page Down** soft keys.
 - f. Press the **Select** soft key or the rotary knob to confirm the selection.
5. To set the channel number for the selected index, complete the following steps:
 - a. Press the **Channel Number** soft key.
 - b. Enter a value by using the numeric keys. You can also use the rotary knob.
 - c. Press the **Enter** soft key.

The instrument displays a corresponding center frequency for the channel number.
6. To set the integration bandwidth for the selected index, complete the following steps:
 - a. Press the **Integration Bandwidth** soft key.
 - b. Enter a value by using the numeric keys. You can also use the rotary knob.
 - c. Select the unit: **GHz**, **MHz**, **kHz**, or **Hz**.
7. To add more channels to be scanned, repeat steps 3-6.
8. Press the **ESC** hard key to dismiss the channel list window and view the scanning result.

To set the frequencies to be scanned:

1. Press the **FREQ/DIST** hard key.
2. Toggle the **Unit** soft key and select **Freq.**
3. Press the **Index** soft key, and then enter an index number between one and six by turning the rotary knob or using the numeric keys.
4. To set the center frequency for the selected index, complete the following steps:
 - a. Press the **Center Frequency** soft key.
 - b. Enter a value by using the numeric keys. You can also use the rotary knob.
 - c. Select the unit: **GHz**, **MHz**, **kHz**, or **Hz**.
5. To set the integration bandwidth for the selected index, complete the following steps:
 - a. Press the **Integration Bandwidth** soft key.
 - b. Enter a value by using the numeric keys. You can also use the rotary knob.
 - c. Select the unit: **GHz**, **MHz**, **kHz**, or **Hz**.
6. To add more channels to be scanned, repeat steps 3-5.
7. Press the **ESC** hard key to dismiss the channel list window and view the scanning result.

Setting number of antenna ports

Procedure

1. Press the **MEASURE SETUP** hot key.
2. Toggle the **MIMO** soft key and select **2x2** or **4x4**.
 This MIMO (Multiple Input Multiple Output) setting is activated only if the option 031 LTE-Advanced TDD is installed with a license number. If not, the instrument sets this option to 2x2 by default. A 2x1 or 4x1 RF combiner is also required to able to test on MIMO channels.

Measurement example

Figure 132 Channel scanner measurement with LTE - TDD OTA signal analyzer



ID scanner

The LTE mobile receives signals from multiple base stations that all of these signals share the same spectrum and are present at the same time. Each base station has unique scrambling code assigned to the particular base station and it differentiates its signal from other base stations in the area.

The ID Scanner shows key parameters such as RSRP (Reference Signal Received Power) and RSRQ (Reference Signal Received Quality) that predict the downlink coverage quickly.

- RSRPs from entire cells help to rank between the different cells as input for handover and cell reselection decisions.
- RSRQ provides additional information when RSRP is not sufficient to make a reliable handover or cell reselection decision.

All of the parameters for OTA ID scanner can be plotted on map data such as Google Maps and Google Earth by using JDViewer.

Setting measure setup

After configuring test parameters as described in the “Configuring test parameters” on page 242, you can continue your measurement.

Procedure

1. Press the **MEASURE SETUP** hot key.
 2. To set the nominal channel bandwidth to be measured, complete the following steps:
 - a. Press the **Bandwidth** soft key.
 - b. Select the bandwidth option: **1.4 MHz, 3 MHz, 5 MHz, 10 MHz, 15 MHz, or 20 MHz**.
 3. *Optional.* Press the **Miscellaneous** soft key, and then do the following(s) as needed:
 - To select the number of antenna ports, toggle the **MIMO** soft key and select **2x2** or **4x4**. This MIMO (Multiple Input Multiple Output) setting is activated only if the option 031 LTE-Advanced TDD is installed with a license number. If not, the instrument sets this option to 2x2 by default. A 2x1 or 4x1 RF combiner is also required to able to test on MIMO channels.
 - To select the cyclic prefix, toggle the **Cyclic Prefix** soft key and select **Normal** or **Extended**. See “Appendix E – Cyclic prefix table” on page 545 for OFDM parameter details by different bandwidth.
 4. *Optional.* Go to **SAVE/LOAD > Save**, and then select the save option from the choices available for your measurement mode. See “Using save” on page 31 for more information.
-

Measurement example

Figure 133 ID scanner measurement with LTE - TDD OTA signal analyzer



Multipath profile

The Multipath Profile enables you to determine RF environmental conditions of testing area. It indicates the amount of power of the dominant pilot signal that is dispersed outside the main correlation peak due to multipath echoes that are expressed in dB. This value should be very small ideally.

The multipath profile is the result of portions of the original broadcast signal arriving at the receiving antenna out of phase. This can be caused by the signal being reflected off objects such as buildings, or being refracted through the atmosphere differently from the main signal.

Setting measure setup

After configuring test parameters as described in the “Configuring test parameters” on page 242, you can continue your measurement.

Procedure

1. Press the **MEASURE SETUP** hot key.
2. To set the nominal channel bandwidth to be measured, complete the following steps:
 - a. Press the **Bandwidth** soft key.
 - b. Select the bandwidth option: **1.4 MHz**, **3 MHz**, **5 MHz**, **10 MHz**, **15 MHz**, or **20 MHz**.
3. Toggle the **Display** soft key and select **RS** or **Sync**.
The RS Window soft key becomes activated if RS is selected.
4. Press the **RS Window** soft key, if RS is selected, and then select the RS window option: **2 μs**, **4 μs**, or **8 μs**.
5. *Optional.* Press the **Miscellaneous** soft key, and then do the following(s) as needed:
 - To select the number of antenna ports, toggle the **MIMO** soft key and select **2x2** or **4x4**. This MIMO (Multiple Input Multiple Output) setting is activated only if the option 031 LTE-Advanced TDD is installed with a license number. If not, the instrument sets this option to 2x2 by default. A 2x1 or 4x1 RF combiner is also required to able to test on MIMO

channels.

- To select the cyclic prefix, toggle the **Cyclic Prefix** soft key and select **Normal** or **Extended**. See “Appendix E – Cyclic prefix table” on page 545 for OFDM parameter details by different bandwidth.
6. *Optional.* Go to **SAVE/LOAD > Save**, and then select the save option from the choices available for your measurement mode. See “Using save” on page 31 for more information.

Measurement example

Figure 134 Multipath profile measurement with LTE - TDD OTA signal analyzer



Control channel

DL RS power is the resource element power of Downlink Reference Symbol. The absolute DL RS power is indicated on the BCH. The absolute accuracy is defined as the maximum deviation between the DL RS power indicated on the BCH and the DL RS power at the BS antenna connector.

The OTA Control Channel provides summary of all control channels including RS power trend over time. GPS coordinates (latitude and longitude) will be displayed on the screen if a GPS antenna is connected and locked to the GPS satellites.

Setting measure setup

After configuring test parameters as described in the “Configuring test parameters” on page 242, you can continue your measurement. The measurement settings can be saved and recalled as a file. You can also use JDViewer, PC application software to configure a measure setup, save as a file, and load the file on to the instrument.

Procedure

1. Press the **MEASURE SETUP** hot key.
2. To set the nominal channel bandwidth to be measured, complete the following steps:
 - a. Press the **Bandwidth** soft key.
 - b. Select the bandwidth option: **1.4 MHz, 3 MHz, 5 MHz, 10 MHz, 15 MHz, or 20 MHz.**

3. To select the subframe number to be measured, complete the following steps:
 - a. Press the **Subframe No** soft key.
 - b. Enter a value by using the numeric keys. You can also use the rotary knob.

NOTE

For MBMS testing, this subframe number must be neither 0 nor 5 as these subframes 0 and 5 are not available for MBMS and it must be set to the MBMS transmitted channel's subframe number.

- c. Press the **Enter** soft key.
4. Toggle the **Cell ID** soft key and select **Auto** or **Manual** as desired:
 - **Auto**: to let the instrument detect the Cell ID for the LTE signal automatically.
 - **Manual**: to set a specific Cell ID for the LTE signal manually in order to speed up the synchronization with a BTS.
5. *Optional.* Press the **Miscellaneous** soft key, and then do the following(s) as needed:
 - To select the number of antenna ports, toggle the **MIMO** soft key and select **2x2** or **4x4**. This MIMO (Multiple Input Multiple Output) setting is activated only if the option 031 LTE-Advanced TDD is installed with a license number. If not, the instrument sets this option to 2x2 by default. A 2x1 or 4x1 RF combiner is also required to test on MIMO channels.
 - To assign a antenna port number automatically or manually, press the **Antenna Port** soft key and select the option: **Auto**, **0**, **1**, **2**, and **3**. If the option 031 LTE-Advanced TDD is not installed or if the MIMO is set to 2x2, the antenna ports 2 and 3 are disabled.
 - To select the cyclic prefix, toggle the **Cyclic Prefix** soft key and select **Normal** or **Extended**. See "Appendix E – Cyclic prefix table" on page 545 for OFDM parameter details by different bandwidth.
 - To turn the Multimedia Broadcast Multicast Service (MBMS) feature on or off, toggle the **MBMS** soft key and select **On** or **Off**. For proper MBMS testing, you need to set the **Subframe No** with the same PMCH subframe number. If this setting is on, the measurement item "MBSFN RS" appears in the result table.
 - To set the Multicast Broadcast Single Frequency Network (MBSFN) detection automatically or manually for MBMS testing, toggle the **MBSFN** soft key and select **Auto** or **Manual**. An automatically detected or manually entered MBSFN ID appears on the screen.
6. Go to **SAVE/LOAD > Save**, and then select the save option from the choices available for your measurement mode. See "Using save" on page 31 for more information.

Setting limit for OTA control channel

Procedure

1. Press the **LIMIT** hot key.
2. Select the test item(s) and set the limit(s) as needed:

To set the limit for	Select	Set
P-SS error vector magnitude	P-SS EVM	High Limit
S-SS error vector magnitude	S-SS EVM	High Limit
RS error vector magnitude	RS EVM > RS0 EVM RS EVM > RS1 EVM RS EVM > RS2 EVM RS EVM > RS3 EVM	High Limit
Frequency error	Frequency Error	High Limit Low Limit

Time error	Time Error	High Limit Low Limit
Time alignment error	Time Alignment Error	High Limit

- Optional. Go to **SAVE/LOAD > Save**, and then select **Limit** to save the limit settings. See "Using save" on page 31 for more information.

Setting display

You can use the **TRACE/DISPLAY** hard key to select the display option.

Procedure

- Press the **TRACE/DISPLAY** hard key.
- Toggle the **Display** soft key and select **Power** or **EVM**. The screen changes according to the selected option.

Measurement example

Figure 135 Control channel measurement with LTE - TDD OTA signal analyzer



Datagram

The OTA Datagram is a time-varying spectral representation that shows how the power of a signal varies with time. The power allocated to the specific resource block will be represented with an amplitude axis (in dBm) and the waterfall diagram will show the trend of past resource block power over certain period. Using a marker function facilitates analysis of accumulated resource block power for data utilization.

Setting measure setup

After configuring test parameters as described in the "Configuring test parameters" on page 242, you can continue your measurement. The measurement settings can be saved and recalled as a file. You can also use JDViewer, PC application software to configure a measure setup, save as a file, and load

the file on to the instrument.

Procedure

1. Press the **MEASURE SETUP** hot key.
2. To set the nominal channel bandwidth to be measured, complete the following steps:
 - a. Press the **Bandwidth** soft key.
 - b. Select the bandwidth option: **1.4 MHz, 3 MHz, 5 MHz, 10 MHz, 15 MHz, or 20 MHz**.
3. To select the subframe number to be measured, complete the following steps:
 - a. Press the **Subframe No** soft key.
 - b. Enter a value by using the numeric keys. You can also use the rotary knob.
 - c. Press the **Enter** soft key.
4. *Optional.* Toggle the **Cell ID** soft key and select **Auto** or **Manual** as desired:
 - **Auto:** to let the instrument detect the Cell ID for the LTE signal automatically.
 - **Manual:** to set a specific Cell ID for the LTE signal manually in order to speed up the synchronization with a BTS.
5. *Optional.* To set the threshold for PDSCH, complete the following steps:
 - a. Press the **PDSCH Threshold** soft key.
 - b. Enter a value by using the numeric keys.
 - c. Press the **dB** soft key.
6. To set the time cursor at a specific position, complete the following steps:
 - a. Toggle the **Time Cursor** soft key and select **On**.
 - b. Turn the rotary knob to move the time cursor. You can also enter a value and then press the **Enter** soft key.

NOTE

Enabling the time cursor puts the measurement on hold and you can make post-processing analysis for each measurement over time using the time cursor.

7. To start a new measurement, press the **Reset/Restart** soft key.
 8. *Optional.* Press the **Miscellaneous** soft key, and then do the following(s) as needed:
 - To select the number of antenna ports, toggle the **MIMO** soft key and select **2x2** or **4x4**. This MIMO (Multiple Input Multiple Output) setting is activated only if the option 031 LTE-Advanced TDD is installed with a license number. If not, the instrument sets this option to 2x2 by default. A 2x1 or 4x1 RF combiner is also required to able to test on MIMO channels.
 - To select the cyclic prefix, toggle the **Cyclic Prefix** soft key and select **Normal** or **Extended**. See “Appendix E – Cyclic prefix table” on page 545 for OFDM parameter details by different bandwidth.
 9. *Optional.* Go to **SAVE/LOAD > Save**, and then select the save option from the choices available for your measurement mode. See “Using save” on page 31 for more information.
-

Measurement example

Figure 136 Datagram measurement with LTE - TDD signal analyzer



Route map

The JD780A Series provides indoor and outdoor mapping function that allows a user to collect data of points in an indoor or outdoor environment and track the received signals and coverage of RF transmitters plotting real time directly on top of a loaded floor plan or a map.

Setting measure setup

Procedure

1. If required, connect a GPS receiver to your JD780A series for outdoor mapping. Indoor mapping does not necessarily need a GPS antenna.
2. Configure test parameters as described in the “Configuring test parameters” on page 242.
3. To load your map file, complete the following steps:
 - a. Plug in your USB drive that has a floor map or .mcf file type created in JDMapCreator.

NOTE

The JDMapCreator converts and resizes any scanned floor plan or layout to fit onto your instrument’s display. You must save your map files (.mcf) into the “SavedMap” folder of your USB drive so that you can load them onto your instrument.

- b. Press **SAVE/LOAD** hot key, and then select **Load > Load Map**. See “Using load” on page 34 for more information.
4. Press the **MEASURE SETUP** hot key.
5. Press the **Plot Point** soft key, and then select the plot point option from the following choices:
 - To collect data/plot points automatically as you move around in a vehicle or outside, press the **GPS** soft key and then toggle the **Screen Mode** soft key between **Map** and **Full**.

NOTE

With the **Map** setting, you can view only the collected points that can be seen within the boundary of the loaded map. If a point is off the map, the instrument displays an arrow to indicate the direction of the current location on the map and the distance from the center

to the location at the top of the screen.

With the **Full** setting, you can view all the collected points of the route without the loaded map.

- To collect data/plot points manually without a GPS antenna in an indoor environment, press the **Position** soft key.

6. Press the **Plot Item** soft key, and then select the measurement option: **RSRP**, **RSRQ**, **RS-SINR**, **S-SS RSSI**, **P-SS Power**, **S-SS Power**, or **S-SS Ec/Io**.

NOTE

The instrument collects the strongest Cell ID's data to plot points.

7. Press the **Bandwidth** soft key to set the nominal channel bandwidth to be measured, and then select the bandwidth option: **1.4 MHz**, **3 MHz**, **5 MHz**, **10 MHz**, **15 MHz**, or **20 MHz**.
8. Toggle the **Plot** soft key and select **Start** to start plotting.
9. Touch directly on the screen or press the **ENTER** hard key to collect data and plot points on the loaded map for the **Position** setting.

NOTE

For the **Position** setting, you can change the direction of the route with the arrow keys and the distance with the rotary knob.

10. Toggle the **Plot** soft key and select **Stop** to stop plotting.
11. Press the **SAVE/LOAD** hot key to save the result.
See "Using save" on page 31 for more information.

NOTE

The instrument does not automatically save the collected data. It is recommended that you save the result. Otherwise, you will lose all the collected data.

Setting limit for route map

You can set the thresholds for each test item.

Procedure

1. Press the **LIMIT** hot key.
2. Select the plot items and set the limits as needed:

To set the limit for	Select	Set
RSRP	RSRP	Excellent, Very Good, Good, Fair, Poor (dBm)
RSRQ	RSRQ	Good, Fair, Poor (dB)
RS-SINR	RS-SINR	Good, Fair, Poor (dB)
S-SS RSSI	S-SS RSSI	Excellent, Very Good, Good, Fair, Poor (dBm)
P-SS Power	P-SS Power	Excellent, Very Good, Good, Fair, Poor (dBm)
S-SS Power	S-SS Power	Excellent, Very Good, Good, Fair, Poor (dBm)
S-SS Ec/Io	S-SS Ec/Io	Good, Fair, Poor (dB)

3. *Optional.* Go to **SAVE/LOAD > Save**, and then select **Limit** to save the limit settings.
See "Using save" on page 31 for more information.

Measurement example

Figure 137 Route map measurement with LTE - TDD OTA signal analyzer

1) RSRP



2) RSRQ

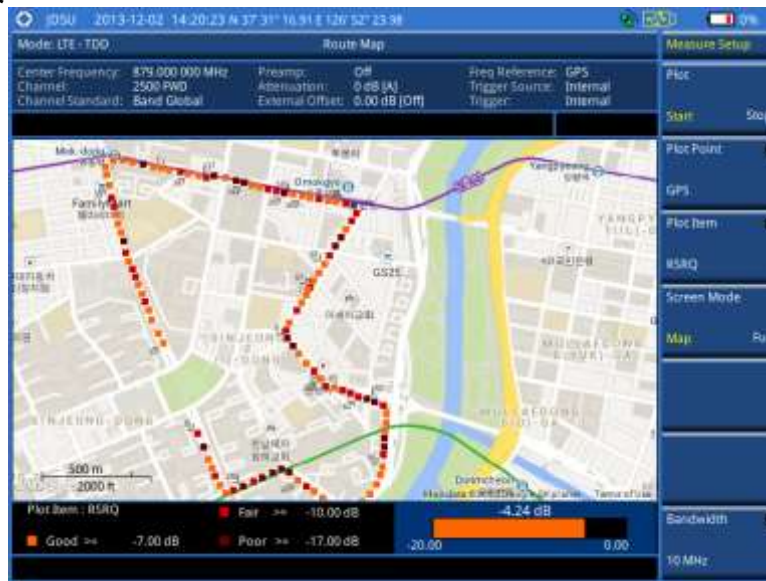

3) RS-SINR



4) S-SS RSSI



5) P-SS Power



6) S-SS Power



7) S-SS Ec/Io

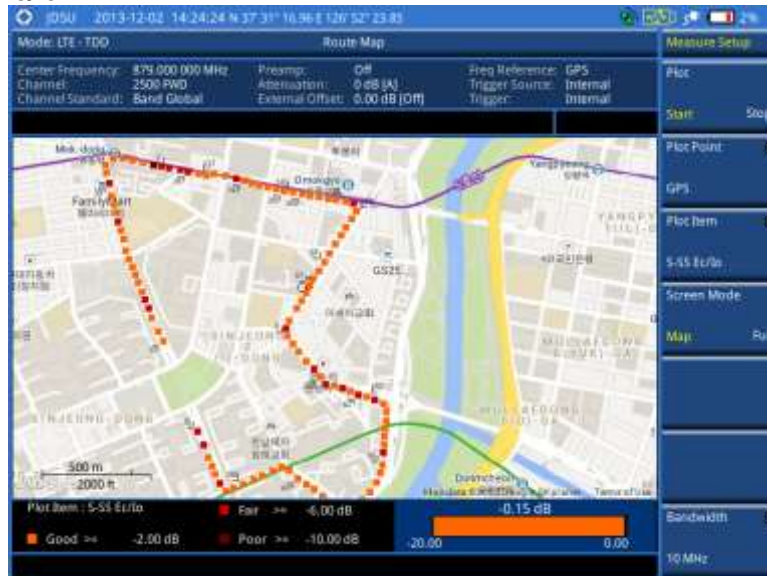

Using CDMA Signal Analyzer

This chapter provides instructions for using the CDMA Signal Analyzer function (option 020) with the CDMA OTA Analyzer function (option 040). Topics discussed in this chapter are as follows:

■ Introduction	304
■ Display overview	305
■ Connecting a cable	305
■ Selecting measurement mode	307
■ Configuring test parameters	307
■ Conducting spectrum measurements	312
■ Conducting RF measurements	314
■ Conducting modulation measurements	321
■ Performing auto measurements	329
■ Performing power statistics CCDF measurements	331
■ Conducting CDMA OTA measurements	332

Introduction

This CDMA Signal Analyzer can be used to test a CDMA transmitter including cdmaOne and cdma2000 signals to check the base station's compliance with following standards documentation.

- 3GPP2 C.S0002 Physical Layer Standard for cdma2000 Spread Spectrum Systems
- 3GPP2 C.S0010 Recommended Minimum Performance Standards for cdma2000 Spread Spectrum Base Station

This instrument automatically makes standard defined measurements using the measurement methods and limits as defined in the standards. Detailed measurement results allow you to analyze cdmaOne and cdma2000 system performance.

- cdmaOne uses dual BPSK (Binary Phase-Shifting Key) for the forward link and OQPSK (Offset Quadrature Phase Shift Keying) for the reverse link.
- cdma2000 uses QPSK (Quadrature Phase Shift Keying) modulation for the forward link and QPSK modulation with HPSK spreading for the reverse link. Both forward and reverse links may have several channels, and individual characteristics for each channel. The chip rate depends on the mode selected.

You may alter the measurement parameters for specialized analysis. Pass/Fail testing with standard defined or user defined upper and lower limits and the Pass/Fail indicator help you to determine base station performance easily.

This instrument provides the following measurement tools for CDMA system:

- Spectrum Analysis
- RF Analysis
 - Channel Power
 - Occupied Bandwidth
 - Spectrum Emission Mask (SEM)
 - Adjacent Channel Power Ratio (ACPR)
 - Multi-ACPR
 - Spurious Emissions
- Modulation Analysis
 - Constellation
 - Code Domain Power
 - Codogram
 - Received Code Strength Indicator (RCSI)
 - CDP Table
- Auto Measure
- Power Statistics CCDF
- Over The Air (OTA)
 - Channel Scanner
 - PN Scanner
 - Multipath Profile
 - Code Domain Power
 - Route Map

Display overview

Figure 138 provides descriptions for each segment of the measurement screen.

Figure 138 CDMA signal analyzer measurement screen

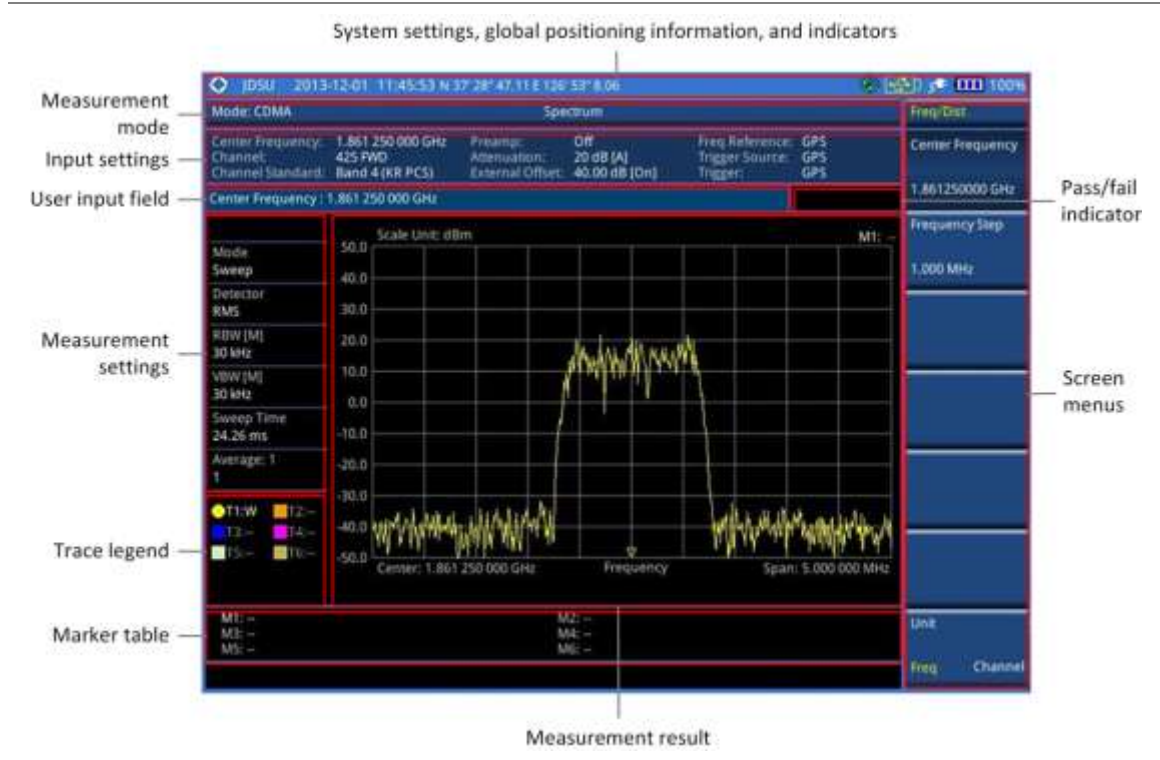

Connecting a cable

Direct connection

Procedure

1. Connect the **Spectrum Analyzer RF In** port of the JD780A series and the Power amplifier output port of BTS.

Figure 139 Direct connection



Indirect connection

Procedure

1. Connect the **Spectrum Analyzer RF In** port of the JD780A series and the monitor (test) port of BTS.

Figure 140 Indirect connection

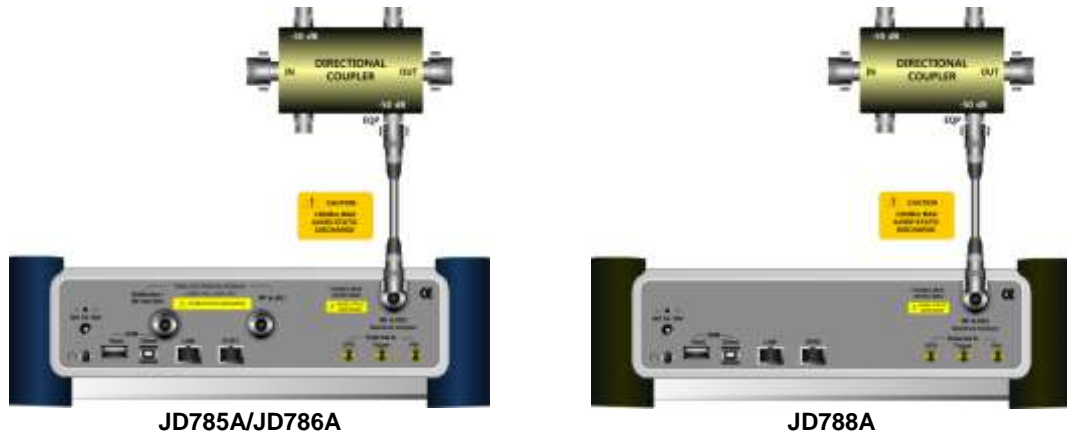

CAUTION

The maximum power for the **Spectrum Analyzer RF In** port is +25 dBm (0.316 W). If the input signal level to be measured is greater than +25 dBm, use a **High Power Attenuator** to prevent damage when you directly connect the signal to the instrument or connect the signal from the coupling port of a directional coupler.

NOTE

For accurate PN Offset and Time Offset measurements with the CDMA Signal Analyzer function, a PP2S should be connected to the External Trigger. Without a GPS connection, measurement results could be invalid numbers.

Over the air (OTA)

Procedure

1. Connect an Omni/directional RF antenna to the **Spectrum Analyzer RF In** port of the JD780A series.
2. Connect a GPS antenna to the **GPS** port of the JD780A series.



CAUTION

If the input signal level to be measured is less than 0 dBm, set 0 dB attenuation or turn on the preamp to have better dynamic range for the OTA testing.

Figure 141 OTA connection

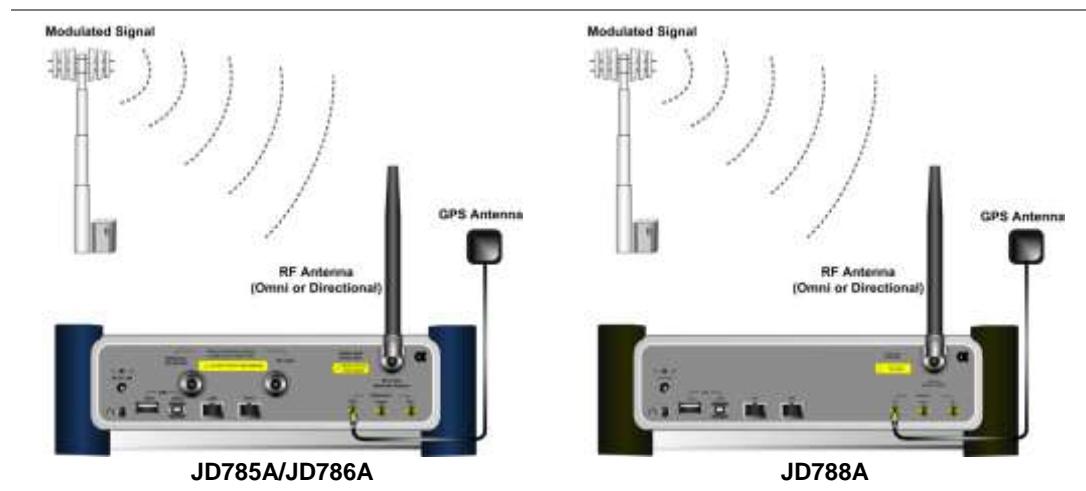

Selecting measurement mode

Procedure

1. Press the **MODE** hard key.
2. Press the **Signal Analyzer** soft key.
3. Press the **CDMA** soft key. The **Spectrum** mode is set by default.
4. Press the **MEASURE** hot key, and then select the measurement mode option from the following choices:
 - Spectrum
 - RF Analysis > Channel Power, Occupied BW, Spectrum Emission Mask, ACPR, Multi-ACPR, or Spurious Emissions
 - Modulation > Constellation, Code Domain Power, Codogram, RCSI, or CDP Table
 - Auto Measure
 - Power Statistics CCDF
 - OTA > Channel Scanner, PN Scanner, Multipath Profile, Code Domain Power, or Route Map

Configuring test parameters

Setting frequency

You can set the frequency with either frequency or channel number. If a frequency to be set matches to the frequency corresponding to the selected channel standard, the instrument calculates its channel number and updates the screen with it automatically.

Procedure

To set the center frequency:

1. Press the **FREQ/DIST** hard key.
2. Toggle the **Unit** soft key and select **Freq**.

3. Press the **Center Frequency** soft key.
4. Enter a value by using the numeric keys. You can also use the rotary knob.
5. Select the unit: **GHz**, **MHz**, **kHz**, or **Hz**.
6. *Optional.* To define the amount of frequency increment for the rotary knob, complete the following steps:
 - a. Press the **Frequency Step** soft key.
 - b. Enter a value by using the numeric keys. You can also use the rotary knob.
 - c. Press the unit: **GHz**, **MHz**, **kHz**, or **Hz**.

To set the channel number:

1. Press the **FREQ/DIST** hard key.
2. Toggle the **Unit** soft key and select **Channel**.
3. To select the standard channel, complete the following steps:
 - a. Press the **Channel Std** soft key. The standard channel window appears. See "Appendix C – Band, frequency & channel standard" on page 541 for more information.
 - b. Select the band to be measured by using the rotary knob, the arrow keys, or the **Page Up/Page Down** soft keys.
 - c. Press the **Select** soft key or the rotary knob to confirm the selection.
4. Press the **Channel Number** soft key.
5. Enter a value by using the numeric keys. You can also use the rotary knob.
6. Press the **Enter** soft key.

The instrument automatically displays the corresponding center frequency value for the selected channel number.

7. *Optional.* To define the amount of channel increment for the rotary knob, complete the following steps:
 - a. Press the **Channel Step** soft key.
 - b. Enter a value by using the numeric keys. You can also use the rotary knob.
 - c. Press the **Enter** soft key.

NOTE

This frequency setting is not used in the Multi-ACLR and Spurious Emissions modes.

Setting amplitude

Reference level and attenuation

You can set the reference and attenuation levels automatically or manually to optimize the display of the traces measured, as you desire.

Procedure

To automatically set the reference and attenuation level:

1. Press the **AMP/SCALE** hard key.
2. Press the **Auto Scale** soft key.
Each time you press this key, both of the Y-axis scale and input attenuation level change to be optimized with some margin.

To set the reference or attenuation level manually:

1. Press the **AMP/SCALE** hard key.
2. To set the maximum reference value on the Y-axis manually, complete the following steps:
 - a. Press the **Reference Level** soft key.
 - b. Enter a value by using the numeric keys or the rotary knob with 10 dB increments.
 - c. Press the **dBm** soft key or the **ENTER** hard key.

NOTE

In the measurements such as **Code Domain Power**, **Codogram**, and **RCSI**, you may need to select the reference option between **Relative** and **Absolute** before setting the reference level.

3. To set the attenuation option, select one from the following choices:
 - To set the input attenuator's level automatically, select **Attenuation > Auto**.

NOTE

It is recommended that you set the **Attenuation to Auto** in most situations so that the level of the input attenuator can be set automatically according to your input signal level.

- To set the input attenuation manually up to 55 dB to optimize S/N, complete the following steps:
 - a. Select **Attenuation > Manual**.
 - b. Press the **Attenuation Value** soft key to set the level.
 - c. Enter a value between 0 and 55 in fives by using the numeric keys.
 - d. Press the **dB** soft key or the **ENTER** hard key.
- To couple the input attenuator's level with your reference level setting, select **Attenuation > Couple**.
As you increase the reference setting, the attenuation level also increases accordingly.

Optional. To change the scale unit:

1. Select **More (1/2) > Units**.
2. Select the unit of the display scale: **dBm**, **dBV**, **dBmV**, **dBμV**, **V**, or **W**.
The scale unit on the screen changes accordingly.

NOTE

This Units menu is available in the Spectrum and RF Analysis modes.

Scale per division

You can use the **Scale/Div** feature available for the spectrum and RF analysis. It represents the value of one division on the horizontal scale. The default setting is 10 dB per division and the maximum value can be set up to 20 dB.

Procedure**To set the scale per division:**

1. Press the **AMP/SCALE** hard key.
2. Select **More (1/2) > Scale/Div**.
3. Enter a value between 1 and 20 by using the numeric keys.
4. Press the **dB** soft key to complete the entry.

Pre-amplifier

You can turn the internal pre-amplifier on to correct and compensate for the gain of the preamp so that amplitude readings show the value at the input connector.

Procedure

1. Press the **AMP/SCALE** hard key.
 2. Toggle the **Preamp** soft key and select **On** or **Off** as needed.
-

NOTE

You can turn the Preamp on when the input attenuation range is from 0 dB to 10 dB. If the attenuation value is manually set to greater than 10 dB, the instrument will automatically turn off the pre-amplifier to display low-level signal properly on the chart.

External offset

You can turn the **External Offset** on and manually set the external offset value. An offset consists of a cable loss and a user offset and the measurement result shows the value reflecting both offset values. When the external offset value is set at 40 dB in the Spectrum mode, the measurement result compensates 40 dB at both the Spectrum Analyzer and Signal Analyzer modes

Procedure

To set the external offset:

1. Press the **AMP/SCALE** hard key.
2. Toggle the **External Offset** soft key and select **On**.
3. Enter a value by using the numeric keys.
4. Press the **dB** soft key to complete the entry.

To turn the external offset off:

1. Press the **AMP/SCALE** hard key.
 2. Toggle the **External Offset** soft key and select **Off**.
-

Setting average

You can set the number of measurements to be averaged for the trace presentation. A maximum of 100 times of averaging can be set. When the averaging reaches to your setting, a new measurement value replaces the measurement value in sequence from the earliest.

Procedure

1. Press the **BW/AVG** hard key.
 2. Press the **Average** soft key.
 3. Enter a value between 1 and 100 as needed by using the numeric keys.
 4. Press the **Enter** soft key.
-

Setting sweep mode

The default settings of the sweep mode are **Continue** and **Normal** to sweep continuously at a normal

speed for most on-going measurements. If you want to hold the measurement or get a single sweep, you can change the sweep mode.

Procedure

To select the single sweep mode:

1. Press the **SWEEP** hot key.
2. Toggle the **Sweep Mode** soft key and select **Single**. You can also use the **HOLD** hot key. The letter **HOLD** in red appears and the sweeping is paused.
3. *Optional.* Press the **Sweep Once** soft key to get a new measurement.

To return to the continuous sweep mode:

1. Toggle the **Sweep Mode** soft key and select **Continue**. You can also use the **HOLD** hot key. The letter **HOLD** in red disappears and the sweeping resumes.
-

Setting trigger source

You can set the trigger source option for your measurements. Connecting an external trigger is necessary for accurate modulation measurements on CDMA systems.

Procedure

1. Press the **TRIGGER** hot key.
 2. Select the trigger source option from the following choices: **Internal**, **External**, or **GPS**.
-

Setting external clock

To enhance the reliability of modulation analysis measurements the JD780A series must be synchronized with a base station. When an external clock is not supplied, the instrument works with its built-in internal high-accuracy time base and some measurement results may exhibit inaccurate values. Therefore, it is highly recommended that you use the same reference clock as the signal source. You can use the **TRIGGER** hot key to set the external clock.

Table 16 Standards of external clock operation

Clock	Type	Reference	Port	Switching Standard
External Reference	Internal	Internal 10 MHz		Default
	External	External Ref Clock	Ext Ref (SMA)	Manual switching (Input signal level >-3 dBm)
	GPS	GPS Clock	GPS (SMA)	Automatic switching (GPS signal received)
Trigger	Internal	Internal Trigger		Default
	External	External Trigger	Trigger (SMA)	Manual switching
	GPS	GPS	GPS (SMA)	Manual switching

Figure 142 Connection ports for external reference clock









Procedure

1. Connect an external reference or a GPS antenna to the JD780A series.
2. Press the **SYSTEM** hot key.
3. Press the **Freq Reference** soft key, and then select the reference option: **Internal**, **External 10 MHz**, **External 13 MHz**, **External 15 MHz**, or **GPS**.

NOTE

When a GPS antenna is connected and locked, GPS coordinates (longitude and latitude) are displayed on the screen and frequency reference is automatically set to GPS in the **System > Freq Reference**.

Table 17 External reference indicators

Type	Indicator	Description
Internal	 (green)	The green INT icon indicates that the instrument uses the built-in internal time base.
External	 (green)	The green EXT icon indicates that an external reference is connected and locked and that the instrument uses the same reference clock as the signal source.
External	 (red)	The red EXT icon indicates that an external reference is connect but not locked.
GPS	 (green)	The green GPS antenna icon indicates that a GPS antenna is connected and locked.
GPS	 (yellow)	The yellow GPS antenna icon indicates that a GPS antenna is connected and locking is in progress.
GPS	 (grey)	The grey GPS antenna icon indicates that a GPS antenna is not connected, failed, or unable to be locked.

Conducting spectrum measurements

If you have configured test parameters as described in the “Configuring test parameters” on page 307, your measurement result is displayed on the screen as like the following example, Figure 143.

Figure 143 Spectrum measurement screen with CDMA signal analyzer



Setting trace

You can display up to six traces on the measurement chart simultaneously.

Procedure

1. Press the **TRACE/DISPLAY** hard key.
2. Press the **Select Trace** soft key, and then select the trace number: **T1**, **T2**, **T3**, **T4**, **T5**, or **T6**. The legend shape of the selected trace changes from square to round to indicate that the trace is the active one now.
3. Toggle the **Trace View** soft key and select **On**.
4. To clear, write or capture, or hide the trace(s), do one of the following:

To	Select	Trace Legend
Clear current data and display with new measurements	Clear Write	W
Display the input signal's maximum response only	Max Hold	M
Display the input signal's minimum response only	Min Hold	m
Capture the selected trace and compare traces	Capture	C
Load a saved trace	More (1/2) > Load	L
Hide the selected trace	Trace View > Off	F
Remove all the traces and initialize the trace settings	More (1/2) > Trace Clear All	

5. To select the detection option, press the **More (1/2) > Detectors**, and then do one of the following:

To display	Select
Random noise better than the peak without missing signals	Normal

The highest value in each data point	Peak
The root mean squared average power across the spectrum	RMS
The lowest value in each data point	Negative Peak
The center value in each data point	Sample

- Optional. Press the **More (1/2) > Trace Info** soft key, and then select the trace number to view the trace's parameter setting information stored at the time of the measurement or **None** to hide the information display.
- Optional. If you have the two traces T1 and T2, you can perform trace math. To view the power difference between the traces, press the **T1 – T2 -> T5** or **T2 – T1 -> T6** soft key. The result is overlaid on the screen along with the second Y-axis.

Conducting RF measurements

Channel power

The Channel Power measurement is a common test used in the wireless industry to measure the total transmitted power of a radio within a defined frequency channel. It acquires a number of points representing the input signal in the time domain, transforms this information into the frequency domain using Fast Fourier Transform (FFT), and then calculates the channel power. The effective resolution bandwidth of the frequency domain trace is proportional to the number of points acquired for the FFT.

The channel power measurement identifies the total RF power, power spectral density (PSD) and peak to average ratio (PAR) of the signal within the channel bandwidth (1.23 MHz for cdmaOne).

After configuring test parameters as described in the “Configuring test parameters” on page 307, your measurement result is displayed on the screen as like the following example, Figure 144.

Figure 144 Channel power measurement with CDMA signal analyzer



NOTE
 You can use the **LIMIT** hot key to analyze your measurements with the user-definable limit and Pass/Fail indication. See “Setting limit for RF tests” on page 320 for more information.

Occupied bandwidth

The Occupied Bandwidth measures the spectrum shape of the carrier. It is defined as the bandwidth, which includes 99% of the transmitted power among total transmitted power.

After configuring test parameters as described in the “Configuring test parameters” on page 307, your measurement result is displayed on the screen as like the following example, Figure 145.

Figure 145 Occupied bandwidth measurement with CDMA signal analyzer



NOTE

You can use the **LIMIT** hot key to analyze your measurements with the user-definable limit and Pass/Fail indication. See “Setting limit for RF tests” on page 320 for more information.

Spectrum emission mask (SEM)

The Spectrum Emission Mask (SEM) measurement required by 3GPP2 specifications encompasses different power limits and different measurement bandwidths (resolution bandwidths) at various frequency offsets. It may be expressed as a ratio of power spectral densities between the carrier and the specified offset frequency band. It provides useful figures-of-merit for the spectral re-growth and emissions produced by components and circuit blocks, without the rigor of performing a full SEM measurement.

The SEM measures spurious signal levels in up to five pairs of offset or region frequencies and relates them to the carrier power.

Setting measure setup

After configuring test parameters as described in the “Configuring test parameters” on page 307, your measurement result is displayed on the screen as like the following example, Figure 146.

Figure 146 SEM measurement with CDMA signal analyzer



NOTE
 You can use the **LIMIT** hot key to analyze your measurements with the user-definable limit and Pass/Fail indication. See “Setting limit for RF tests” on page 320 for more information.

ACPR

The Adjacent Channel Power Ratio (ACPR) is defined as the ratio of the average power in the adjacent frequency channel (or offset) to the average power in the transmitted frequency channel. It may be expressed as the ratio of the integrated signal power in the adjacent channel to the integrated signal power in the main channel.

After configuring test parameters as described in the “Configuring test parameters” on page 307, your measurement result is displayed on the screen as like the following example, Figure 147.

Figure 147 ACPR measurement with CDMA signal analyzer



NOTE

You can use the **LIMIT** hot key to analyze your measurements with the user-definable limit and Pass/Fail indication. See “Setting limit for RF tests” on page 320 for more information.

Multi-ACPR

The Multi-ACPR measurement is used to perform multi-channel ACPR measurements with as many channels as possible. It helps you to measure ACPR in multi-channel transmitting base station environment.

Setting frequency for Multi-ACPR

You can set the frequency with either frequency or channel number.

Procedure

1. Press the **MEASURE SETUP** hot key.
 2. To set the frequency, do one of the following:
 - To set the center frequency, complete the following steps:
 - a. Toggle the **Unit** soft key and select **Freq.**
 - b. Press the **Lowest Frequency** soft key to set the starting center frequency.
 - c. Enter a value by using the numeric keys. You can also use the rotary knob.
 - d. Select the unit: **GHz, MHz, kHz, or Hz.**
 - e. Press the **Highest Frequency** soft key to set the stopping center frequency.
 - f. Enter a value by using the numeric keys. You can also use the rotary knob.
 - g. Select the unit: **GHz, MHz, kHz, or Hz.**
 - To set the channel number, complete the following steps:
 - a. Toggle the **Unit** soft key and select **Channel.**
 - b. To select the standard channel, press the **Channel Std** soft key and then select the band to be measured.
 - c. Press the **Lowest Channel** soft key to set the starting channel.
 - d. Enter a value by using the numeric keys. You can also use the rotary knob.
 - e. Press the **Enter** soft key.
 - f. Press the **Highest Channel** soft key to set the stopping channel.
 - g. Enter a value by using the numeric keys. You can also use the rotary knob.
 - h. Press the **Enter** soft key.
-

After configuring test parameters, your measurement result is displayed on the screen as like the following example, Figure 148.

Figure 148 Multi-ACPR measurement with CDMA signal analyzer



NOTE
 You can use the **LIMIT** hot key to analyze your measurements with the user-definable limit and Pass/Fail indication. See “Setting limit for RF tests” on page 320 for more information.

Spurious emissions

Out-of-band emissions are unwanted emissions immediately outside the channel bandwidth resulting from the modulation process and non-linearity in the transmitter but excluding spurious emissions. The Spurious Emissions measurement is to identify and determine the power level of out-of-band spurious emission within the necessary channel bandwidth and modulated signal measured at the RF port of the Base Station.

Setting measure setup

Procedure

1. Press the **MEASURE SETUP** hot key.
2. To set up the range table and frequency range, press the **Range Table** soft key and then complete the following steps:
 - a. Press the **Range** soft key, and then enter the range number to add a new range or change an existing one.
 - b. Press the **Enter** soft key.
 - c. Press the **Start Frequency** soft key to set up the frequency range.
 - d. Enter a value by using the numeric keys. You can also use the rotary knob.
 - e. Select the unit: **GHz**, **MHz**, **kHz**, or **Hz**.
 - f. Press the **Stop Frequency** soft key to set up the frequency range.
 - g. Enter a value by using the numeric keys. You can also use the rotary knob.
 - h. Select the unit: **GHz**, **MHz**, **kHz**, or **Hz**.
3. Toggle the **Range** soft key between **On** and **Off** to display or hide the selected range.
4. To set up the test limits for Pass/Fail indication, complete the following steps:

-
- a. Press the **Start Limit** soft key.
 - b. Enter a value by using the numeric keys. You can also use the rotary knob.
 - c. Select the **dBm** soft key.
 - d. Press the **Stop Limit** soft key.
 - e. Enter a value by using the numeric keys. You can also use the rotary knob.
 - f. Select the **dBm** soft key.
5. To set up the other parameters, complete the following steps:
- a. Select **More (1/2) > Attenuation** to set up the attenuation value.
 - b. Enter a value in the multiple of five.
 - c. Press the **dB** soft key or the **ENTER** hard key.
 - d. Press the **RBW** soft key.
 - e. Enter a value by using the numeric keys.
 - f. Select the unit: **GHz**, **MHz**, **kHz**, or **Hz**.
 - g. Press the **VBW** soft key.
 - h. Enter a value by using the numeric keys.
 - i. Select the unit: **GHz**, **MHz**, **kHz**, or **Hz**.
6. Press the **PREV** hard key.
7. Toggle the **Measure Type** soft key between **Examine** and **Full** to select the measurement type.

NOTE

The **Examine** mode displays only the selected range while the **Full** mode lets the instrument automatically change the selected range from one another.

8. Set the number of measurements to be averaged:
- a. Press the **Average** soft key.
 - b. Enter a value between 1 and 100.
 - c. Press the **Enter** soft key.

After configuring test parameters as described in the “Configuring test parameters” on page 307, your measurement result is displayed on the screen as like the following example, Figure 149.

Figure 149 Spurious emissions measurement with CDMA signal analyzer



NOTE
 You can use the **LIMIT** hot key to analyze your measurements with the user-definable limit and Pass/Fail indication. See “Setting limit for RF tests” on page 320 for more information.

Setting limit for RF tests

By default, test limits specified in the standard are set for you. You can change thresholds if you desire.

Procedure

1. Press the **LIMIT** hot key.
2. Press the **RF Test Limits** soft key.
3. Select the test item(s) and set the limit(s) depending on your selected measurement mode:

To set the limit for	Select	Set
Channel power	Channel Power	High Limit Low Limit
Occupied bandwidth	Occupied BW	High Limit
Spectrum emission mask	Spectrum Emission Mask	(On/Off only)
ACPR	ACPR	(On/Off only)
Multi-ACPR	Multi-ACPR	(On/Off only)
Spurious emissions	Spurious Emissions	(On/Off only)

4. *Optional.* You can enable alarm sound that goes off if the measurement falls outside of the limit. Toggle the **Beep** soft key between **On** and **Off** to enable or disable the beep sound.
5. *Optional.* Go to **SAVE/LOAD > Save**, and then select **Limit** to save the limit settings. See “Using save” on page 31 for more information.

Conducting modulation measurements

In order to make accurate measurements of time offset and PN, you must connect an external trigger before making a modulation measurement.

Constellation

The Constellation is used to observe some aspects of modulation accuracy and can reveal certain fault mechanisms such as I/Q amplitude imbalance or quadrature imbalance. It displays constellation diagram by modulation types.

Setting measure setup

After configuring test parameters as described in the “Configuring test parameters” on page 307, you can continue your measurement. The measurement settings can be saved and recalled as a file. You can also use JDViewer, PC application software to configure a measure setup, save as a file, and load the file on to the instrument.

Procedure

1. Press the **MEASURE SETUP** hot key.
 2. To set the Pseudo-Noise (PN) offset, complete the following steps:
 - a. Toggle the **PN Offset** soft key between **Auto** and **Manual**.
 - b. Enter a value by using the numeric keys to set manually.
 - c. Press the **Enter** soft key.
 3. To set the incremental step for the PN offset, complete the following steps:
 - a. Press the **PN Increment** soft key.
 - b. Enter a value by using the numeric keys.
 - c. Press the **Enter** soft key.
 4. *Optional.* Go to **SAVE/LOAD > Save**, and then select the save option from the choices available for your measurement mode. See “Using save” on page 31 for more information.
-

Measurement example

Figure 150 Constellation measurement with CDMA signal analyzer



NOTE

You can use the **LIMIT** hot key to analyze your measurements with the user-definable limit and Pass/Fail indication. See “Setting limit for modulation tests” on page 328 for more information.

Code domain power

The Code Domain Power (CDP) measures the distribution of power across the set of code channels, normalized to the total power. It helps to verify that each code channel is operating at its proper level and to identify problems throughout the transmitter design from coding to the RF section. System imperfections such as amplifier non-linearity will present themselves as an undesired distribution of power in the code domain.

Setting measure setup

After configuring test parameters as described in the “Configuring test parameters” on page 307, you can continue your measurement. The measurement settings can be saved and recalled as a file. You can also use JDViewer, PC application software to configure a measure setup, save as a file, and load the file on to the instrument.

Procedure

1. Press the **MEASURE SETUP** hot key.
2. To set the Pseudo-Noise (PN) offset, complete the following steps:
 - a. Toggle the **PN Offset** soft key between **Auto** and **Manual**.
 - b. Enter a value by using the numeric keys to set manually.
 - c. Press the **Enter** soft key.
3. To set the incremental step for the PN offset, complete the following steps:
 - a. Press the **PN Increment** soft key.
 - b. Enter a value by using the numeric keys.

- c. Press the **Enter** soft key.
4. To set the threshold between Auto and Manual, complete the following steps:
 - a. Press the **Threshold** soft key. Its default setting is -27 dB.
 - b. Enter a value between -50 and zero by using the numeric keys to change the value in the Manual mode.
 - c. Press the **Enter** soft key.
5. Toggle the **Q-Paging** soft key between **On** and **Off** to enable or disable the quick page channel that indicates the power of Quick Page Walsh code 80.
6. *Optional.* Go to **SAVE/LOAD > Save**, and then select the save option from the choices available for your measurement mode. See “Using save” on page 31 for more information.

Measurement example

Figure 151 Code domain power measurement with CDMA signal analyzer



NOTE
 You can use the **LIMIT** hot key to analyze your measurements with the user-definable limit and Pass/Fail indication. See “Setting limit for modulation tests” on page 328 for more information.

Setting display

You can view your measurement results in a different view option.

Procedure

1. Press the **TRACE/DISPLAY** hard key.
2. Press the **Code Order** soft key, and then select the code order option from the following choices:
 - **Hadamard:** To assign the number based on Walsh code order and display the measured code power according to the assigned number in sequence.
 - **Bit Reverse:** Code number in binary bit is reversed relative to the Hadamard method.
3. Toggle the **Base Code Length** soft key and select the base Walsh code number: **64** or **128**.

Codogram

The Codogram displays how the code level is changing over time and makes it easier for you to view traffic channels as they initiate and terminate and to track traffic channels call levels over time. The Codogram measurements can be saved into an external USB memory so that a post-analysis can be done with the application software JDViewer.

Setting measure setup

After configuring test parameters as described in the “Configuring test parameters” on page 307, you can continue your measurement. The measurement settings can be saved and recalled as a file. You can also use JDViewer, PC application software to configure a measure setup, save as a file, and load the file on to the instrument.

Procedure

1. Press the **MEASURE SETUP** hot key.
2. To set the Pseudo-Noise (PN) offset, complete the following steps:
 - a. Toggle the **PN Offset** soft key between **Auto** and **Manual**.
 - b. Enter a value by using the numeric keys to set manually.
 - c. Press the **Enter** soft key.
3. To set the incremental step for the PN offset, complete the following steps:
 - a. Press the **PN Increment** soft key.
 - b. Enter a value by using the numeric keys.
 - c. Press the **Enter** soft key.
4. To set the threshold between Auto and Manual, complete the following steps:
 - a. Press the **More (1/2) > Threshold** soft key. Its default setting is -27 dB.
 - b. Enter a value between -50 and zero by using the numeric keys to change the value in the Manual mode.
 - c. Press the **Enter** soft key.
5. Toggle the **More (1/2) > Q-Paging** soft key between **On** and **Off** to enable or disable the quick page channel that indicates the power of Quick Page Walsh code 80.
6. To set the time interval, complete the following steps:
 - a. Press the **Time Interval** soft key.
 - b. Enter a value by using the numeric keys.
 - c. Press the **Enter** soft key.
7. To place the time cursor to analyze your measurements, complete the following steps:
 - a. Toggle the **Time Cursor** soft key between **On** and **Off** to enable or disable the time cursor.
 - b. Enter a value by using the numeric keys.
 - c. Press the **Enter** soft key.

NOTE

When the time cursor is enabled, the measurement is put on hold and information about the time cursor is displayed.

8. *Optional.* Go to **SAVE/LOAD > Save**, and then select the save option from the choices available for your measurement mode. See “Using save” on page 31 for more information.
-

Measurement example

Figure 152 Codogram in full view with CDMA signal analyzer



Setting display

You can view your measurement results in a different view option.

Procedure

1. Press the **TRACE/DISPLAY** hard key.
2. Press the **Code Order** soft key, and then select the code order option from the following choices:
 - **Hadamard**: To assign the number based on Walsh code order and display the measured code power according to the assigned number in sequence.
 - **Bit Reverse**: Code number in binary bit is reversed relative to the Hadamard method.
3. Toggle the **Base Code Length** soft key and select the base Walsh code number: **64** or **128**.

RCSI

The Received Code Strength Indicator (RCSI) is used to track the power variation of cdmaOne or cdma2000 control channels such as Pilot, Paging, Sync, and Q-Paging over time. The RCSI measurements can be saved into an external USB memory so that a post-analysis can be done with the application software JDViewer.

Setting measure setup

After configuring test parameters as described in the “Configuring test parameters” on page 307, you can continue your measurement. The measurement settings can be saved and recalled as a file. You can also use JDViewer, PC application software to configure a measure setup, save as a file, and load the file on to the instrument.

Procedure

1. Press the **MEASURE SETUP** hot key.

2. To set the Pseudo-Noise (PN) offset, complete the following steps:
 - a. Toggle the **PN Offset** soft key between **Auto** and **Manual**.
 - b. Enter a value by using the numeric keys to set manually.
 - c. Press the **Enter** soft key.
3. To set the incremental step for the PN offset, complete the following steps:
 - a. Press the **PN Increment** soft key.
 - b. Enter a value by using the numeric keys.
 - c. Press the **Enter** soft key.
4. To set the threshold between Auto and Manual, complete the following steps:
 - a. Press the **Threshold** soft key. Its default setting is -27 dB.
 - b. Enter a value between -50 and zero by using the numeric keys to change the value in the Manual mode.
 - c. Press the **Enter** soft key.
5. Toggle the **Q-Paging** soft key between **On** and **Off** to enable or disable the quick page channel that indicates the power of Quick Page Walsh code 80.
6. Press the **Alarm Code** soft key, and then select the alarm code option: **None**, **Pilot**, **Page**, **Sync**, or **Quick Page**.
7. To set the alarm mask, complete the following steps:
 - a. Press the **Set Mask** soft key.
 - b. Enter a value by using the numeric keys.
 - c. Press the **[dB|dBm]** soft key.
8. *Optional.* Go to **SAVE/LOAD > Save**, and then select the save option from the choices available for your measurement mode. See “Using save” on page 31 for more information.

Measurement example

Figure 153 RCSI measurement with CDMA signal analyzer



Setting display

You can view your measurement results in a different view option.

Procedure

1. Press the **TRACE/DISPLAY** hard key.
 2. Press the **Code Order** soft key, and then select the code order option from the following choices:
 - **Hadamard**: To assign the number based on Walsh code order and display the measured code power according to the assigned number in sequence.
 - **Bit Reverse**: Code number in binary bit is reversed relative to the Hadamard method.
 3. Toggle the **Base Code Length** soft key and select the base Walsh code number: **64** or **128**.
-

CDP Table

The CDP Table is used to look at a numeric and textual description of all the active code channels in the signal.

Setting measure setup

After configuring test parameters as described in the “Configuring test parameters” on page 307, you can continue your measurement. The measurement settings can be saved and recalled as a file. You can also use JDViewer, PC application software to configure a measure setup, save as a file, and load the file on to the instrument.

Procedure

1. Press the **MEASURE SETUP** hot key.
 2. To set the Pseudo-Noise (PN) offset, complete the following steps:
 - a. Toggle the **PN Offset** soft key between **Auto** and **Manual**.
 - b. Enter a value by using the numeric keys to set manually.
 - c. Press the **Enter** soft key.
 3. To set the incremental step for the PN offset, complete the following steps:
 - a. Press the **PN Increment** soft key.
 - b. Enter a value by using the numeric keys.
 - c. Press the **Enter** soft key.
 4. To set the threshold between Auto and Manual, complete the following steps:
 - a. Press the **Threshold** soft key. Its default setting is -27 dB.
 - b. Enter a value between -50 and zero by using the numeric keys to change the value in the Manual mode.
 - c. Press the **Enter** soft key.
 5. Toggle the **Q-Paging** soft key between **On** and **Off** to enable or disable the quick page channel that indicates the power of Quick Page Walsh code 80.
-

Measurement example

Figure 154 CDP Table measurement with CDMA signal analyzer



Setting display

If the CDP table spans over to the next page(s), you can change pages up and down to view your measurement results.

Procedure

1. Press the **TRACE/DISPLAY** hard key.
2. Press the **Code Order** soft key, and then select the code order option from the following choices:
 - **Hadamard**: To assign the number based on Walsh code order and display the measured code power according to the assigned number in sequence.
 - **Bit Reverse**: Code number in binary bit is reversed relative to the Hadamard method.
3. Toggle the **Base Code Length** soft key and select the base Walsh code number: **64** or **128**.
4. Select **Page Up** or **Page Down** as needed to scroll the screen up and down.

Setting limit for modulation tests

Procedure

1. Press the **LIMIT** hot key.
2. Press the **Modulation Test Limits** soft key.
3. Select the test item(s) and set the limit(s) depending on your selected measurement mode:

To set the limit for	Select	Set
Frequency error	Frequency Error	High Limit Low Limit
Time offset	Time Offset	High Limit Low Limit

Waveform quality (Rho)	Rho	Low Limit
Carrier feed through	Carrier Feed Through	High Limit
Pilot power	Pilot Power	High Limit [Abs Rel] Low Limit [Abs Rel]
Highest level among inactive channels	Max Inactive	High Limit

4. *Optional.* You can enable alarm sound that goes off if the measurement falls outside of the limit. Toggle the **Beep** soft key between **On** and **Off** to enable or disable the beep sound.
5. *Optional.* Go to **SAVE/LOAD > Save**, and then select **Limit** to save the limit settings. See “Using save” on page 31 for more information.

NOTE

The Time Offset compares the PN offset timing with the overall system time and the instrument checks the start of PN offset in comparison to either the GPS signal or the even second clock signal.

NOTE

The Rho measures the modulation quality for a CDMA transmitter along with EVM and Walsh Channel Power. It includes all errors occurred along the transmitter chain such as base band filtering, abnormality of I/Q modulator and distortion in power amplifier. A perfect Rho value is 1.0 indicating that all of the power is being transmitted correctly.

NOTE

The Carrier Feed Through is a result of the RF carrier signal feeding through the I/Q modulator and riding on the output circuitry without being modulated.

Performing auto measurements

The Auto Measure function of the JD780A series allows a complete signal profiling covering RF characterization and modulation quality parameters of up to 10 different carriers, particularly useful on an overlay architecture where base stations are transmitting in different frequencies.

The Auto Measure can be easily executed either by selecting a menu in the instrument or by running a programmed scenario in the PC-based application so that the instrument automatically configure and perform tests on every aspect of all the carriers.

Setting limit for auto measure

You can set test limits for test item(s) in the auto measurement.

Procedure

1. Press the **LIMIT** hot key.
2. Press the **RF Test Limits** soft key, and then enable test limits as desired.
3. Press the **Modulation Test Limits** soft key, and then enable test limits as desired.
4. *Optional.* You can enable alarm sound that goes off if the measurement falls outside of the limit. Toggle the **Beep** soft key between **On** and **Off** to enable or disable the beep sound.
5. *Optional.* Go to **SAVE/LOAD > Save**, and then select **Limit** to save the limit settings. See “Using save” on page 31 for more information.

Setting measure setup

After configuring test parameters as described in the “Configuring test parameters” on page 307, you can continue your measurement. The measurement settings can be saved and recalled as a file. You can also use JDViewer, PC application software to configure a measure setup, save as a file, and load the file on to the instrument.

Procedure

1. Press the **MEASURE SETUP** hot key.
 2. Toggle the **Configuration** soft key and select the configuration option:
 - **Current**: to let the instrument use current frequency (single carrier) and determine pass or fail based on the instrument’s limit settings in Auto Measure.
 - **Scenario**: to run a test with a programmed scenario in JDViewer. The Scenario menu becomes activated.
 3. To load a scenario, press the **Scenario** soft key, and then select a scenario file to load.
 4. Toggle the **Test Time** soft key and select the test time option:
 - **Now**: to let the instrument run a test only once.
 - **Schedule**: to let the instrument repeat tests as defined in the Set Timing. The Set Timing menu becomes activated.
 5. To define a schedule for an auto measurement, complete the following steps:
 - a. Press the **Set Timing** soft key.
 - b. Press the **Start Time (HH:MM)** soft key.
 - c. Enter the time in the HH:MM format, and then press the **Enter** soft key.
 - d. Press the **Stop Time (HH:MM)** soft key.
 - e. Enter the time in the HH:MM format, and then press the **Enter** soft key.
 - f. Press the **Time Interval** soft key.
 - g. Enter the amount of time in minutes, and then press the **Enter** soft key.
 6. To set external offset, complete the following steps:
 - a. Toggle the **External Offset** soft key and select **On**.
 - b. Enter a value by using the numeric keys, and then press the **dB** soft key.
 6. To save your settings and results, go to **SAVE/LOAD > Save** and then perform functions as you desire. See “Using save” on page 31 for more information.
 7. Press the **Run Test** soft key to start to run a test. The Auto Measure Results window appears at the end of the test.
 8. To stop running the test, press the **Abort** soft key.
 9. To change the view on the screen during the test, press the **Display** and then select the view option from the following choices:
 - **Screen**: You can view each measurement screen as the test progresses.
 - **Results**: You can view a measurement result table as the test progresses.
 - **Settings**: You can view a measurement setting table as the test progresses.
-

Setting display

After completion of the auto measurement, the screen menu changes to Trace/Display so that you can view the results in different forms.

Procedure

1. Toggle the **Display** soft key and select the display option:
 - **Result:** to view the result table.
The Display Result menu becomes activated.
 - **Settings:** to view the measurement settings for the auto measurement.
 2. Toggle the **Display Result** soft key and select the display result option:
 - **Full:** to view detailed measurement readings with the pass/fail indication.
 - **Quick:** to view only the Pass/Fail results.
 3. To view the measurement results for a different carrier, press the **View Carrier** soft key and then select the carrier number to view.
-

Performing power statistics CCDF measurements

The Power Statistics Complementary Cumulative Distribution Function (CCDF) measurement characterizes the power statistics of the input signal. It provides PAR (Peak to Average power Ratio) versus different probabilities.

Setting measure setup

After configuring test parameters as described in the “Configuring test parameters” on page 307, you can continue your measurement. The measurement settings can be saved and recalled as a file. You can also use JDViewer, PC application software to configure a measure setup, save as a file, and load the file on to the instrument.

Procedure

1. Press the **MEASURE SETUP** hot key.
 2. Press the **CCDF Length** soft key to set the length of the CCDF.
 3. Enter a value between 1 and 100 by using the numeric keys. You can also use the rotary knob.
 4. Press the **Enter** soft key.
-

Measurement example

Figure 155 CCDF measurement with CDMA signal analyzer



Conducting CDMA OTA measurements

This Over The Air (OTA) measurement has channel scanner, PN scanner, multipath profile, and Code Domain power screens. It is used to verify CDMA transmitter performance at any location providing reflective measurements and identifying signals providing from different sites. The Code Domain power shows not only modulation performance metric but also amplifier capacity and code utilization metric. The Amplifier capacity (code utilization) measurement is an estimate of the amount of power amplifier capacity (code utilization) that is being used expressed in percent of maximum.

Channel scanner

Setting channel/frequency

Procedure

To set the channels to be scanned:

1. Press the **FREQ/DIST** hard key.
2. Toggle the **Unit** soft key and select **Channel**.
3. Press the **Index** soft key, and then enter an index number between one and six by turning the rotary knob or using the numeric keys.
4. To select the standard channel, complete the following steps:
 - a. Press the **Channel Std** soft key. The standard channel window appears. See "Appendix C – Band, frequency & channel standard" on page 541 for more information.
 - b. Select the band to be measured by using the rotary knob, the arrow keys, or the **Page Up/Page Down** soft keys.
 - c. Press the **Select** soft key or the rotary knob to confirm the selection.
5. To set the channel number for the selected index, complete the following steps:
 - a. Press the **Channel Number** soft key.
 - b. Enter a value by using the numeric keys. You can also use the rotary knob.

-
- c. Press the **Enter** soft key.

The instrument displays a corresponding center frequency for the channel number.

6. To set the integration bandwidth for the selected index, complete the following steps:
 - a. Press the **Integration Bandwidth** soft key.
 - b. Enter a value by using the numeric keys. You can also use the rotary knob.
 - c. Select the unit: **GHz**, **MHz**, **kHz**, or **Hz**.
7. To add more channels to be scanned, repeat steps 3-6.
8. Press the **ESC** hard key to dismiss the channel list window and view the scanning result.

To set the frequencies to be scanned:

1. Press the **FREQ/DIST** hard key.
 2. Toggle the **Unit** soft key and select **Freq**.
 3. Press the **Index** soft key, and then enter an index number between one and six by turning the rotary knob or using the numeric keys.
 4. To set the center frequency for the selected index, complete the following steps:
 - a. Press the **Center Frequency** soft key.
 - b. Enter a value by using the numeric keys. You can also use the rotary knob.
 - c. Select the unit: **GHz**, **MHz**, **kHz**, or **Hz**.
 5. To set the integration bandwidth for the selected index, complete the following steps:
 - a. Press the **Integration Bandwidth** soft key.
 - b. Enter a value by using the numeric keys. You can also use the rotary knob.
 - c. Select the unit: **GHz**, **MHz**, **kHz**, or **Hz**.
 6. To add more channels to be scanned, repeat steps 3-5.
 7. Press the **ESC** hard key to dismiss the channel list window and view the scanning result.
-

Setting measure setup

After configuring other test parameters as described in the “Configuring test parameters” on page 307, you can continue your measurement. The measurement settings can be saved and recalled as a file. You can also use JDViewer, PC application software to configure a measure setup, save as a file, and load the file on to the instrument.

Procedure

1. Press the **MEASURE SETUP** hot key.
 2. To set the incremental step for the PN offset, complete the following steps:
 - a. Press the **PN Increment** soft key.
 - b. Enter a value by using the numeric keys.
 - c. Press the **Enter** soft key.
 3. *Optional.* Go to **SAVE/LOAD > Save**, and then select the save option from the choices available for your measurement mode. See “Using save” on page 31 for more information.
-

Setting limit for OTA channel scanner

Procedure

1. Press the **LIMIT** hot key.
2. Press the **Limit Line** soft key to set a threshold for the limit line and Pass/Fail indication.
3. Enter a value, and then press the **dBm** unit soft key.
4. Toggle the **Limit Line** soft key between **On** and **Off** to display or dismiss the limit line.
5. *Optional.* You can enable alarm sound that goes off if the measurement falls outside of the limit. Toggle the **Beep** soft key between **On** and **Off** to enable or disable the beep sound.
6. *Optional.* Go to **SAVE/LOAD > Save**, and then select **Limit** to save the limit settings. See "Using save" on page 31 for more information.

Measurement example

Figure 156 Channel scanner measurement with CDMA OTA signal analyzer



PN scanner

Each access network sector has a unique PN offset. The PN Scanner is used to identify all the active PNs in an area.

Setting measure setup

After configuring test parameters as described in the "Configuring test parameters" on page 307, you can continue your measurement. The measurement settings can be saved and recalled as a file. You can also use JDViewer, PC application software to configure a measure setup, save as a file, and load the file on to the instrument.

Procedure

1. Press the **MEASURE SETUP** hot key.
2. To set the incremental step for the PN offset, complete the following steps:

- a. Press the **PN Increment** soft key.
 - b. Enter a value by using the numeric keys.
 - c. Press the **Enter** soft key.
3. *Optional.* Go to **SAVE/LOAD > Save**, and then select the save option from the choices available for your measurement mode. See "Using save" on page 31 for more information.

Measurement example

Figure 157 PN scanner measurement with CDMA OTA signal analyzer



Multipath profile

The Multipath Profile enables you to determine RF environmental conditions of testing area. It indicates the amount of power of the dominant pilot signal that is dispersed outside the main correlation peak due to multipath echoes that are expressed in dB. This value should be very small ideally.

The multipath profile is the result of portions of the original broadcast signal arriving at the receiving antenna out of phase. This can be caused by the signal being reflected off objects such as buildings, or being refracted through the atmosphere differently from the main signal.

Setting measure setup

After configuring test parameters as described in the "Configuring test parameters" on page 307, you can continue your measurement. The measurement settings can be saved and recalled as a file. You can also use JDViewer, PC application software to configure a measure setup, save as a file, and load the file on to the instrument.

Procedure

1. Press the **MEASURE SETUP** hot key.
2. To set the incremental step for the PN offset, complete the following steps:
 - a. Press the **PN Increment** soft key.

- b. Enter a value by using the numeric keys.
 - c. Press the **Enter** soft key.
3. *Optional.* Go to **SAVE/LOAD > Save**, and then select the save option from the choices available for your measurement mode. See “Using save” on page 31 for more information.

Measurement example

Figure 158 Multipath profile measurement with CDMA OTA signal analyzer



Code domain power

Channels with high correlation factors are determined to be active channels and are indicated as such on the display. Once the channels are decoded, the analyzer determines the power of each channel relative to the total signal power.

This measurement helps to verify that each code channel is operating at its proper level and helps to identify problems throughout the transmitter design from the coding to the RF section. System imperfections, such as the non-linearity of amplifiers, will present themselves as an undesired distribution of power in the code domain.

Setting measure setup

After configuring test parameters as described in “Configuring test parameters” on page 307, you can continue your measurement. The measurement settings can be saved and recalled as a file. You can also use JDViewer, PC application software to configure a measure setup, save as a file, and load the file on to the instrument.

Procedure

1. Press the **MEASURE SETUP** hot key.
2. To set the Pseudo-Noise (PN) offset, complete the following steps:
 - a. Toggle the **PN Offset** soft key between **Auto** and **Manual**.

-
- b. Enter a value by using the numeric keys to set manually.
 - c. Press the **Enter** soft key.
 3. To set the incremental step for the PN offset, complete the following steps:
 - a. Press the **PN Increment** soft key.
 - b. Enter a value by using the numeric keys.
 - c. Press the **Enter** soft key.
 4. To set the threshold between Auto and Manual, complete the following steps:
 - a. Press the **Threshold** soft key. Its default setting is -27 dB.
 - b. Enter a value between -50 and zero by using the numeric keys to change the value in the Manual mode.
 - c. Press the **Enter** soft key.
 5. Toggle the **Q-Paging** soft key between **On** and **Off** to enable or disable the quick page channel that indicates the power of Quick Page Walsh code 80.
 6. To set the maximum amplifier power, complete the following steps:
 - a. Press the **Max Amplifier Power** soft key.
 - b. Enter a value by using the numeric keys.
 - c. Press the **dBm** soft key.
 7. To set the pilot power, complete the following steps:
 - a. Press the **Pilot Power** soft key.
 - b. Enter a value by using the numeric keys.
 - c. Press the **dBm** soft key.
 8. To set the threshold for pilot dominance, complete the following steps:
 - a. Press the **More (1/2) > Pilot Dominance >** soft key.
 - b. Enter a value by using the numeric keys.
 - c. Press the **Enter** soft key.

NOTE

Recommended value is 10. Color of the Pilot Dominance indicator on the screen bases on this setting.

9. To set the threshold for multipath power, complete the following steps:
 - a. Press the **More (1/2) > Multipath Power <** soft key.
 - b. Enter a value by using the numeric keys.
 - c. Press the **Enter** soft key.

NOTE

Recommended value is one. Color of the multipath power indicator on the screen bases on this setting.

10. *Optional.* Go to **SAVE/LOAD > Save**, and then select the save option from the choices available for your measurement mode. See "Using save" on page 31 for more information.
-

Measurement example

Figure 159 Code domain power measurement with CDMA OTA signal analyzer



NOTE

You can use the **LIMIT** hot key to analyze your measurements with the user-definable limit and Pass/Fail indication.

Setting display

You can view your measurement results in a different view option.

Procedure

1. Press the **TRACE/DISPLAY** hard key.
2. Press the **Code Order** soft key, and then select the code order option from the following choices:
 - **Hadamard**: To assign the number based on Walsh code order and display the measured code power according to the assigned number in sequence.
 - **Bit Reverse**: Code number in binary bit is reversed relative to the Hadamard method.
3. Toggle the **Base Code Length** soft key and select the base Walsh code number: **64** or **128**.

Route map

The JD780A Series provides indoor and outdoor mapping function that allows a user to collect data of points in an indoor or outdoor environment and track the received signals and coverage of RF transmitters plotting real time directly on top of a loaded floor plan or a map.

Setting measure setup

Procedure

1. If required, connect a GPS receiver to your JD780A series for outdoor mapping. Indoor mapping does not necessarily need a GPS antenna.
2. Configure test parameters as described in the “Configuring test parameters” on page 307.

3. To load your map file, complete the following steps:
 - a. Plug in your USB drive that has a floor map or `.mcf` file type created in JMapCreator.

NOTE

The JMapCreator converts and resizes any scanned floor plan or layout to fit onto your instrument's display. You must save your map files (`.mcf`) into the "**SavedMap**" folder of your USB drive so that you can load them onto your instrument.

- b. Press **SAVE/LOAD** hot key, and then select **Load > Load Map**.
See "Using load" on page 34 for more information.
4. Press the **MEASURE SETUP** hot key.
5. Press the **Plot Point** soft key, and then select the plot point option from the following choices:
 - To collect data/plot points automatically as you move around in a vehicle or outside, press the **GPS** soft key and then toggle the **Screen Mode** soft key between **Map** and **Full**.

NOTE

With the **Map** setting, you can view only the collected points that can be seen within the boundary of the loaded map. If a point is off the map, the instrument displays an arrow to indicate the direction of the current location on the map and the distance from the center to the location at the top of the screen. With the **Full** setting, you can view all the collected points of the route without the loaded map.

- To collect data/plot points manually without a GPS antenna in an indoor environment, press the **Position** soft key.
6. Press the **Plot Item** soft key, and then select the measurement option: **Pilot Power** or **Ec/Io**.
 7. To set the incremental step for the PN offset, complete the following steps:
 - a. Press the **PN Increment** soft key.
 - b. Enter a value by using the numeric keys.
 - c. Press the **Enter** soft key.
 8. Toggle the **Plot** soft key and select **Start**.
 9. Touch directly on the screen or press the **ENTER** hard key to collect data and plot points on the loaded map for the **Position** setting.

NOTE

For the **Position** setting, you can change the direction of the route with the arrow keys and the distance with the rotary knob.

10. Toggle the **Plot** soft key and select **Stop** to stop plotting.
11. Press the **SAVE/LOAD** hot key to save the result.
See "Using save" on page 31 for more information.

NOTE

The instrument does not automatically save the collected data. It is recommended that you save the result. Otherwise, you will lose all the collected data.

Setting limit

You can set the thresholds for the four different color indicators for Pilot power or Ec/Io.

Procedure

1. Press the **LIMIT** hot key.
2. To set the limits for pilot power if you have selected Pilot for the plot item, complete the following steps:

- a. Press the **Pilot Power** soft key.
 - b. Press the **Excellent** soft key to set its threshold.
 - c. Enter a value, and then press the **dBm** soft key. You can also use the rotary knob.
 - d. Press the **Very Good** soft key to set its threshold.
 - e. Enter a value, and then press the **dBm** soft key. You can also use the rotary knob.
 - f. Press the **Good** soft key to set its threshold.
 - g. Enter a value, and then press the **dBm** soft key. You can also use the rotary knob.
 - h. Press the **Fair** soft key to set its threshold.
 - i. Enter a value, and then press the **dBm** soft key. You can also use the rotary knob.
 - j. Press the **Poor** soft key to set its threshold.
 - k. Enter a value, and then press the **dBm** soft key. You can also use the rotary knob.
3. To set the limits for Ec/Io if you have selected as for the plot item , complete the following steps:
 - a. Press the **Ec/Io** soft key.
 - b. Press the **Good** soft key to set its threshold.
 - c. Enter a value, and then press the **Enter** soft key. You can also use the rotary knob.
 - d. Press the **Fair** soft key to set its threshold.
 - e. Enter a value, and then press the **Enter** soft key. You can also use the rotary knob.
 - f. Press the **Poor** soft key to set its threshold.
 - g. Enter a value, and then press the **Enter** soft key. You can also use the rotary knob.
 4. *Optional.* Go to **SAVE/LOAD > Save**, and then select **Limit** to save the limit settings. See “Using save” on page 31 for more information.

Measurement example

Figure 160 Route map measurement with CDMA OTA signal analyzer

1) Pilot Power



2) Pilot Ec/Io

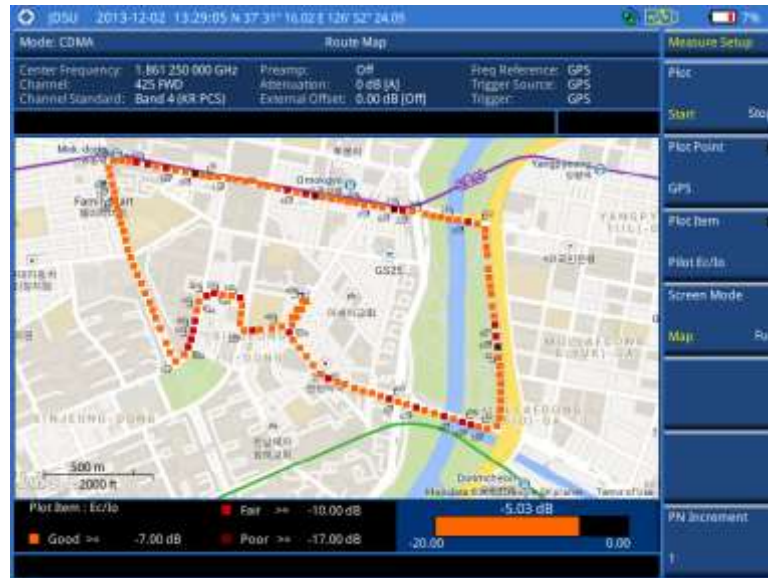

Using EV-DO Signal Analyzer

This chapter provides instructions for using the EV-DO Signal Analyzer function (option 021) with the EV-DO OTA Analyzer function (option 041). Topics discussed in this chapter are as follows:

■ Introduction	343
■ Display overview	343
■ Connecting a cable	344
■ Selecting measurement mode	346
■ Configuring test parameters	346
■ Conducting spectrum measurements	351
■ Conducting RF measurements	352
■ Conducting power vs. time measurements	359
■ Conducting modulation measurements	361
■ Performing auto measurements	371
■ Performing power statistics CCDF measurements	373
■ Conducting EV-DO OTA measurements	374

Introduction

The EV-DO Signal Analyzer of the JD780A series performs power and spectrum measurements as well as modulation analysis to test the proper transmitter performance of EV-DO systems. It performs conformance testing according to the following standards providing a simple Pass/Fail indication on each test.

- 3GPP2 C.S0024-B. cdma2000 High Rate Packet Data Air Interface Specification
- 3GPP2 C.S0032-B. Recommended Minimum Performance Standards for cdma2000 High Rate Packet Data Access Network

You may alter the measurement parameters for specialized analysis. Pass/Fail testing with standard defined or user defined upper and lower limits and the Pass/Fail indicator help you to determine base station performance easily.

This instrument provides the following measurement tools for EV-DO system:

- Spectrum Analysis
- RF Analysis
 - Channel Power
 - Occupied Bandwidth
 - Spectrum Emission Mask (SEM)
 - Adjacent Channel Power Ratio (ACLR)
 - Multi-ACPR
 - Spurious Emissions
- Power vs. Time: Idle Slot and Active Slot
- Modulation Analysis
 - Constellation
 - Code Domain Power
 - MAC Codogram
 - Received Code Strength Indicator (RCSI)
 - MAC CDP Table
- Auto Measure
- Power Statistics CCDF
- Over The Air (OTA)
 - Channel Scanner
 - PN Scanner
 - Multipath Profile
 - Code Domain Power
 - Route Map

Display overview

Figure 161 provides descriptions for each segment of the measurement screen.

Figure 161 EV-DO signal analyzer measurement screen

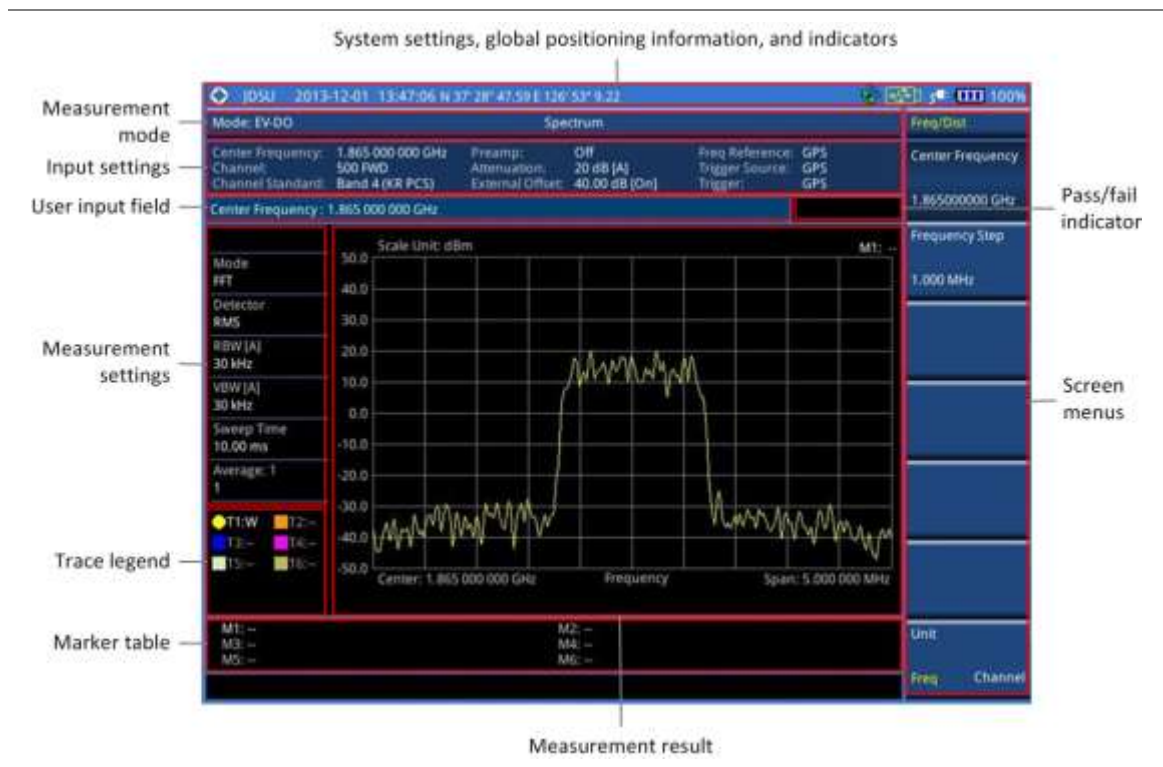

Connecting a cable

Direct connection

Procedure

1. Connect the **Spectrum Analyzer RF In** port of the JD780A series and the Power amplifier output port of BTS.

Figure 162 Direct connection



Indirect connection

Procedure

1. Connect the **Spectrum Analyzer RF In** port of the JD780A series and the monitor (test) port of BTS.

Figure 163 Indirect connection

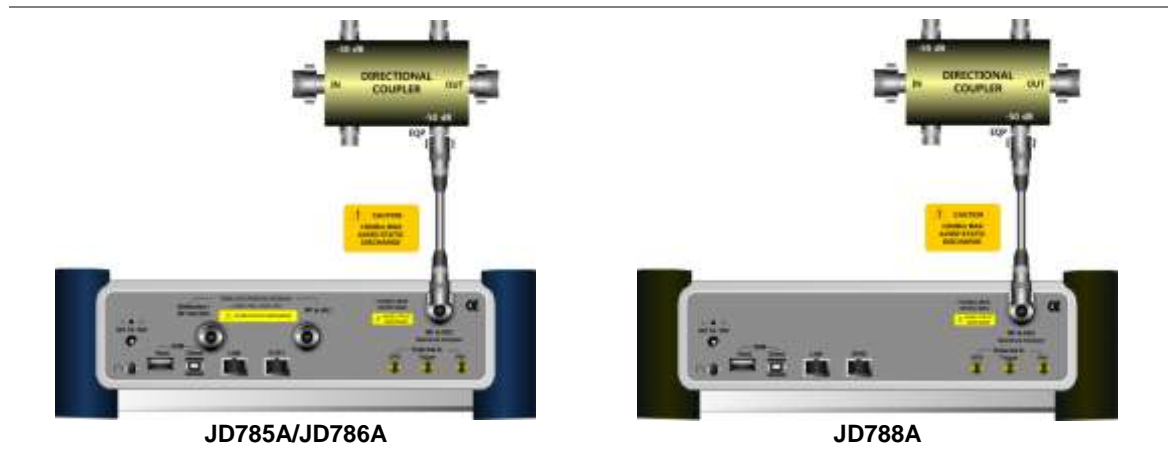

CAUTION
 The maximum power for the **Spectrum Analyzer RF In** port is +25 dBm (0.316 W). If the input signal level to be measured is greater than +25 dBm, use a **High Power Attenuator** to prevent damage when you directly connect the signal to the instrument or connect the signal from the coupling port of a directional coupler.

Over the air (OTA)

Procedure

1. Connect an Omni/directional RF antenna to the **Spectrum Analyzer RF In** port of the JD780A series.
2. Connect a GPS antenna to the **GPS** port of the JD780A series.

Figure 164 OTA connection

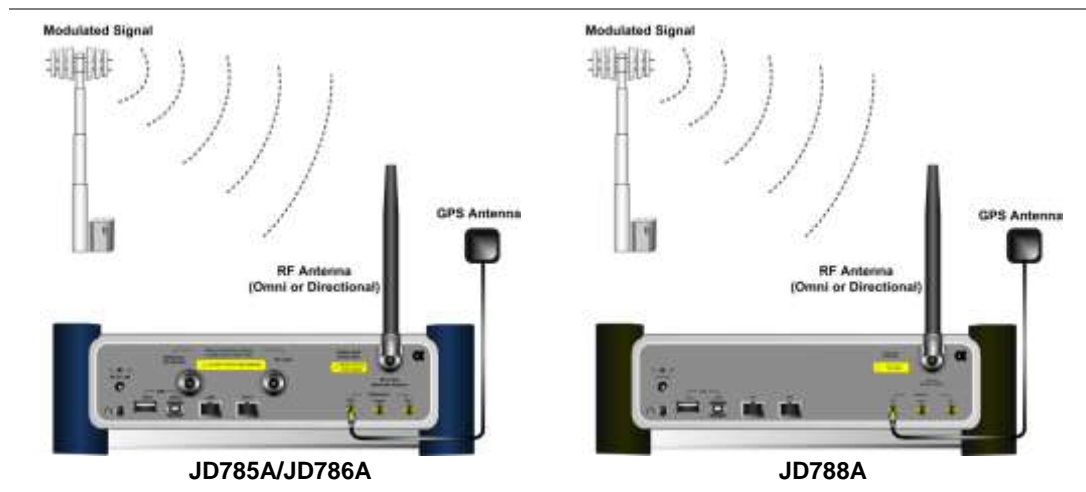

CAUTION
 If the input signal level to be measured is less than 0 dBm, set 0 dB attenuation or turn on the preamp to have better dynamic range for the OTA testing.

Selecting measurement mode

Procedure

1. Press the **MODE** hard key.
 2. Press the **Signal Analyzer** soft key.
 3. Press the **EV-DO** soft key. The **Spectrum** mode is set by default.
 4. Press the **MEASURE** hot key, and then select the measurement mode option from the following choices:
 - Spectrum
 - RF Analysis > Channel Power, Occupied BW, Spectrum Emission Mask, ACPR, Multi-ACPR, or Spurious Emissions
 - Power vs Time > Power vs Time (Idle Slot) or Power vs Time (Active Slot)
 - Modulation Analysis > Constellation > Composite 64, Composite 128, Pilot, MAC 64, MAC 128, or Data
 - Modulation Analysis > Code Domain Power > Pilot, MAC 64, MAC 128, or Data
 - Modulation Analysis > MAC Codogram, RCSI, or MAC CDP Table
 - Auto Measure
 - Power Statistics CCDF
 - OTA > Channel Scanner, PN Scanner, Multipath Profile, Code Domain Power, or Route Map
-

Configuring test parameters

Setting frequency

You can set the frequency with either frequency or channel number. If a frequency to be set matches to the frequency corresponding to the selected channel standard, the instrument calculates its channel number and updates the screen with it automatically.

Procedure

To set the center frequency:

1. Press the **FREQ/DIST** hard key.
2. Toggle the **Unit** soft key and select **Freq**.
3. Press the **Center Frequency** soft key.
4. Enter a value by using the numeric keys. You can also use the rotary knob.
5. Select the unit: **GHz**, **MHz**, **kHz**, or **Hz**.
6. *Optional.* To define the amount of frequency increment for the rotary knob, complete the following steps:
 - a. Press the **Frequency Step** soft key.
 - b. Enter a value by using the numeric keys. You can also use the rotary knob.
 - c. Press the unit: **GHz**, **MHz**, **kHz**, or **Hz**.

To set the channel number:

1. Press the **FREQ/DIST** hard key.
-

2. Toggle the **Unit** soft key and select **Channel**.
3. To select the standard channel, complete the following steps:
 - a. Press the **Channel Std** soft key. The standard channel window appears. See "Appendix C – Band, frequency & channel standard" on page 541 for more information.
 - b. Select the band to be measured by using the rotary knob, the arrow keys, or the **Page Up/Page Down** soft keys.
 - c. Press the **Select** soft key or the rotary knob to confirm the selection.
4. Press the **Channel Number** soft key.
5. Enter a value by using the numeric keys. You can also use the rotary knob.
6. Press the **Enter** soft key.

The instrument automatically displays the corresponding center frequency value for the selected channel number.

7. *Optional.* To define the amount of channel increment for the rotary knob, complete the following steps:
 - a. Press the **Channel Step** soft key.
 - b. Enter a value by using the numeric keys. You can also use the rotary knob.
 - c. Press the **Enter** soft key.

NOTE

This frequency setting is not used in the Multi-ACLR and Spurious Emissions modes.

Setting amplitude

Reference level and attenuation

You can set the reference and attenuation levels automatically or manually to optimize the display of the traces measured, as you desire.

Procedure

To automatically set the reference and attenuation level:

1. Press the **AMP/SCALE** hard key.
2. Press the **Auto Scale** soft key.
Each time you press this key, both of the Y-axis scale and input attenuation level change to be optimized with some margin.

To set the reference or attenuation level manually:

1. Press the **AMP/SCALE** hard key.
2. To set the maximum reference value on the Y-axis manually, complete the following steps:
 - a. Press the **Reference Level** soft key.
 - b. Enter a value by using the numeric keys or the rotary knob with 10 dB increments.
 - c. Press the **dBm** soft key or the **ENTER** hard key.

NOTE

In the measurements such as **Code Domain Power** and **MAC Codogram**, you may need to select the reference option between **Relative** and **Absolute** before setting the reference level.

3. To set the attenuation option, select one from the following choices:
 - To set the input attenuator's level automatically, select **Attenuation > Auto**.
-

NOTE

It is recommended that you set the **Attenuation** to **Auto** in most situations so that the level of the input attenuator can be set automatically according to your input signal level.

- To set the input attenuation manually up to 55 dB to optimize S/N, complete the following steps:
 - a. Select **Attenuation > Manual**.
 - b. Press the **Attenuation Value** soft key to set the level.
 - c. Enter a value between 0 and 55 in fives by using the numeric keys.
 - d. Press the **dB** soft key or the **ENTER** hard key.
- To couple the input attenuator's level with your reference level setting, select **Attenuation > Couple**.
As you increase the reference setting, the attenuation level also increases accordingly.

Optional. To change the scale unit:

1. Select **More (1/2) > Units**.
2. Select the unit of the display scale: **dBm**, **dBV**, **dBmV**, **dBμV**, **V**, or **W**.
The scale unit on the screen changes accordingly.

NOTE

This Units menu is available in the Spectrum and RF Analysis modes.

Scale per division

You can use the **Scale/Div** feature available for the spectrum and RF analysis. It represents the value of one division on the horizontal scale. The default setting is 10 dB per division and the maximum value can be set up to 20 dB.

Procedure**To set the scale per division:**

1. Press the **AMP/SCALE** hard key.
2. Select **More (1/2) > Scale/Div**.
3. Enter a value between 1 and 20 by using the numeric keys.
4. Press the **dB** soft key to complete the entry.

Pre-amplifier

You can turn the internal pre-amplifier on to correct and compensate for the gain of the preamp so that amplitude readings show the value at the input connector.

Procedure

1. Press the **AMP/SCALE** hard key.
2. Toggle the **Preamp** soft key and select **On** or **Off** as needed.

NOTE

You can turn the Preamp on when the input attenuation range is from 0 dB to 10 dB. If the attenuation value is manually set to greater than 10 dB, the instrument will automatically turn off the pre-amplifier to display low-level signal properly on the chart.

External offset

You can turn the **External Offset** on and manually set the external offset value. An offset consists of a cable loss and a user offset and the measurement result shows the value reflecting both offset values. When the external offset value is set at 40 dB in the Spectrum mode, the measurement result compensates 40 dB at both the Spectrum Analyzer and Signal Analyzer modes

Procedure

To set the external offset:

1. Press the **AMP/SCALE** hard key.
2. Toggle the **External Offset** soft key and select **On**.
3. Enter a value by using the numeric keys.
4. Press the **dB** soft key to complete the entry.

To turn the external offset off:

1. Press the **AMP/SCALE** hard key.
 2. Toggle the **External Offset** soft key and select **Off**.
-

Setting average

You can set the number of measurements to be averaged for the trace presentation. A maximum of 100 times of averaging can be set. When the averaging reaches to your setting, a new measurement value replaces the measurement value in sequence from the earliest.

Procedure

1. Press the **BW/AVG** hard key.
 2. Press the **Average** soft key.
 3. Enter a value between 1 and 100 as needed by using the numeric keys.
 4. Press the **Enter** soft key.
-

Setting sweep mode

The default settings of the sweep mode are **Continue** and **Normal** to sweep continuously at a normal speed for most on-going measurements. If you want to hold the measurement or get a single sweep, you can change the sweep mode.

Procedure

To select the single sweep mode:

1. Press the **SWEEP** hot key.
2. Toggle the **Sweep Mode** soft key and select **Single**. You can also use the **HOLD** hot key. The letter **HOLD** in red appears and the sweeping is paused.
3. *Optional.* Press the **Sweep Once** soft key to get a new measurement.

To return to the continuous sweep mode:

1. Toggle the **Sweep Mode** soft key and select **Continue**. You can also use the **HOLD** hot key. The letter **HOLD** in red disappears and the sweeping resumes.
-

Setting trigger source

You can set the trigger source option for your measurements. Connecting an external trigger is necessary for accurate modulation measurements on EV-DO systems.

Procedure
1. Press the TRIGGER hot key.
2. Select the trigger source option from the following choices: Internal , External , or GPS .

Setting external clock

To enhance the reliability of modulation analysis measurements the JD780A series must be synchronized with a base station. When an external clock is not supplied, the instrument works with its built-in internal high-accuracy time base and some measurement results may exhibit inaccurate values. Therefore, it is highly recommended that you use the same reference clock as the signal source. You can use the **TRIGGER** hot key to set the external clock.

Table 18 Standards of external clock operation

Clock	Type	Reference	Port	Switching Standard
External Reference	Internal	Internal 10 MHz		Default
	External	External Ref Clock	Ext Ref (SMA)	Manual switching (Input signal level >-3 dBm)
	GPS	GPS Clock	GPS (SMA)	Automatic switching (GPS signal received)
Trigger	Internal	Internal Trigger		Default
	External	External Trigger	Trigger (SMA)	Manual switching
	GPS	GPS	GPS (SMA)	Manual switching







Figure 165 Connection ports for external reference clock



Procedure
1. Connect an external reference or a GPS antenna to the JD780A series.
2. Press the SYSTEM hot key.
3. Press the Freq Reference soft key, and then select the reference option: Internal , External 10 MHz , External 13 MHz , External 15 MHz , or GPS .

NOTE
 When a GPS antenna is connected and locked, GPS coordinates (longitude and latitude) are displayed on the screen and frequency reference is automatically set to GPS in the **System > Freq Reference**.

Table 19 External reference indicators

Type	Indicator	Description
Internal	 (green)	The green INT icon indicates that the instrument uses the built-in internal time base.
External	 (green)	The green EXT icon indicates that an external reference is connected and locked and that the instrument uses the same reference clock as the signal source.
External	 (red)	The red EXT icon indicates that an external reference is connect but not locked.
GPS	 (green)	The green GPS antenna icon indicates that a GPS antenna is connected and locked.
GPS	 (yellow)	The yellow GPS antenna icon indicates that a GPS antenna is connected and locking is in progress.
GPS	 (grey)	The grey GPS antenna icon indicates that a GPS antenna is not connected, failed, or unable to be locked.

Conducting spectrum measurements

If you have configured test parameters as described in the “Configuring test parameters” on page 346, your measurement result is displayed on the screen as like the following example, Figure 166.

Figure 166 Spectrum measurement screen with EV-DO signal analyzer



Setting trace

You can display up to six traces on the measurement chart simultaneously.

Procedure

1. Press the **TRACE/DISPLAY** hard key.
2. Press the **Select Trace** soft key, and then select the trace number: **T1, T2, T3, T4, T5, or T6**. The legend shape of the selected trace changes from square to round to indicate that the trace is the active one now.
3. Toggle the **Trace View** soft key and select **On**.
4. To clear, write or capture, or hide the trace(s), do one of the following:

To	Select	Trace Legend
Clear current data and display with new measurements	Clear Write	W
Display the input signal's maximum response only	Max Hold	M
Display the input signal's minimum response only	Min Hold	m
Capture the selected trace and compare traces	Capture	C
Load a saved trace	More (1/2) > Load	L
Hide the selected trace	Trace View > Off	F
Remove all the traces and initialize the trace settings	More (1/2) > Trace Clear All	

5. *Optional.* Press the **More (1/2) > Trace Info** soft key, and then select the trace number to view the trace's parameter setting information stored at the time of the measurement or **None** to hide the information display.
 6. *Optional.* If you have the two traces T1 and T2, you can perform trace math. To view the power difference between the traces, press the **T1 – T2 -> T5** or **T2 – T1 -> T6** soft key. The result is overlaid on the screen along with the second Y-axis.
-

Conducting RF measurements

Channel power

The Channel Power measurement is a common test used in the wireless industry to measure the total transmitted power of a radio within a defined frequency channel. It acquires a number of points representing the input signal in the time domain, transforms this information into the frequency domain using Fast Fourier Transform (FFT), and then calculates the channel power. The effective resolution bandwidth of the frequency domain trace is proportional to the number of points acquired for the FFT.

The channel power measurement identifies the total RF power, power spectral density (PSD) and peak to average ratio (PAR) of the signal in the EV-DO channel bandwidth (1.23 MHz).

After configuring test parameters as described in the “Configuring test parameters” on page 346, your measurement result is displayed on the screen as like the following example, Figure 167.

Figure 167 Channel power measurement with EV-DO signal analyzer



NOTE

You can use the **LIMIT** hot key to analyze your measurements with the user-definable limit and Pass/Fail indication. See “Setting limit for RF tests” on page 358 for more information.

Occupied bandwidth

The Occupied Bandwidth measures the spectrum shape of the carrier. It is defined as the bandwidth, which includes 99% of the transmitted power among total transmitted power.

After configuring test parameters as described in the “Configuring test parameters” on page 346, your measurement result is displayed on the screen as like the following example, Figure 168.

Figure 168 Occupied bandwidth measurement with EV-DO signal analyzer



NOTE

You can use the **LIMIT** hot key to analyze your measurements with the user-definable limit and Pass/Fail indication. See “Setting limit for RF tests” on page 358 for more information.

Spectrum emission mask (SEM)

The Spectrum Emission Mask (SEM) measurement required by 3GPP2 specifications encompasses different power limits and different measurement bandwidths (resolution bandwidths) at various frequency offsets. It may be expressed as a ratio of power spectral densities between the carrier and the specified offset frequency band. It provides useful figures-of-merit for the spectral re-growth and emissions produced by components and circuit blocks, without the rigor of performing a full SEM measurement.

The SEM measures spurious signal levels in up to five pairs of offset or region frequencies and relates them to the carrier power.

Setting measure setup

After configuring test parameters as described in the “Configuring test parameters” on page 346, your measurement result is displayed on the screen as like the following example, Figure 169.

Figure 169 SEM measurement with EV-DO signal analyzer



NOTE

You can use the **LIMIT** hot key to analyze your measurements with the user-definable limit and Pass/Fail indication. See “Setting limit for RF tests” on page 358 for more information.

ACPR

The Adjacent Channel Power Ratio (ACPR) is defined as the ratio of the average power in the adjacent frequency channel (or offset) to the average power in the transmitted frequency channel. It may be expressed as the ratio of the integrated signal power in the adjacent channel to the integrated signal power in the main channel.

After configuring test parameters as described in the “Configuring test parameters” on page 346, your measurement result is displayed on the screen as like the following example, Figure 170.

Figure 170 ACPR measurement with EV-DO signal analyzer



NOTE
 You can use the **LIMIT** hot key to analyze your measurements with the user-definable limit and Pass/Fail indication. See “Setting limit for RF tests” on page 358 for more information.

Multi-ACPR

The Multi-ACPR measurement is used to perform multi-channel ACPR measurements with as many channels as possible. It helps you to measure ACPR in multi-channel transmitting Base Station environment.

Setting frequency for Multi-ACPR

You can set the frequency with either frequency or channel number.

Procedure

1. Press the **MEASURE SETUP** hot key.
2. To set the frequency, do one of the following:
 - To set the center frequency, complete the following steps:
 - a. Toggle the **Unit** soft key and select **Freq**.
 - b. Press the **Lowest Frequency** soft key to set the starting center frequency.
 - c. Enter a value by using the numeric keys. You can also use the rotary knob.
 - d. Select the unit: **GHz**, **MHz**, **kHz**, or **Hz**.
 - e. Press the **Highest Frequency** soft key to set the stopping center frequency.
 - f. Enter a value by using the numeric keys. You can also use the rotary knob.
 - g. Select the unit: **GHz**, **MHz**, **kHz**, or **Hz**.
 - To set the channel number, complete the following steps:

- a. Toggle the **Unit** soft key and select **Channel**.
- b. To select the standard channel, press the **Channel Std** soft key and then select the band to be measured.
- c. Press the **Lowest Channel** soft key to set the starting channel.
- d. Enter a value by using the numeric keys. You can also use the rotary knob.
- e. Press the **Enter** soft key.
- f. Press the **Highest Channel** soft key to set the stopping channel.
- g. Enter a value by using the numeric keys. You can also use the rotary knob.
- h. Press the **Enter** soft key.

After configuring the test parameters, your measurement result is displayed on the screen as like the following example, Figure 171.

Figure 171 Multi-ACPR measurement with EV-DO signal analyzer



NOTE
 You can use the **LIMIT** hot key to analyze your measurements with the user-definable limit and Pass/Fail indication. See “Setting limit for RF tests” on page 358 for more information.

Spurious emissions

Out-of-band emissions are unwanted emissions immediately outside the channel bandwidth resulting from the modulation process and non-linearity in the transmitter but excluding spurious emissions. The Spurious Emissions measurement is to identify and determine the power level of out-of-band spurious emission within the necessary channel bandwidth and modulated signal measured at the RF port of the Base Station.

Setting measure setup

Procedure

1. Press the **MEASURE SETUP** hot key.

2. To set up the range table and frequency range, press the **Range Table** soft key and then complete the following steps:
 - a. Press the **Range** soft key, and then enter the range number to add a new range or change an existing one.
 - b. Press the **Enter** soft key.
 - c. Press the **Start Frequency** soft key to set up the frequency range.
 - d. Enter a value by using the numeric keys. You can also use the rotary knob.
 - e. Select the unit: **GHz**, **MHz**, **kHz**, or **Hz**.
 - f. Press the **Stop Frequency** soft key to set up the frequency range.
 - g. Enter a value by using the numeric keys. You can also use the rotary knob.
 - h. Select the unit: **GHz**, **MHz**, **kHz**, or **Hz**.
 3. Toggle the **Range** soft key between **On** and **Off** to display or hide the selected range.
 4. To set up the test limits for Pass/Fail indication, complete the following steps:
 - a. Press the **Start Limit** soft key.
 - b. Enter a value by using the numeric keys. You can also use the rotary knob.
 - c. Select the **dBm** soft key.
 - d. Press the **Stop Limit** soft key.
 - e. Enter a value by using the numeric keys. You can also use the rotary knob.
 - f. Select the **dBm** soft key.
 5. To set up the other parameters, complete the following steps:
 - a. Select **More (1/2) > Attenuation** to set up the attenuation value.
 - b. Enter a value in the multiple of five.
 - c. Press the **dB** soft key or the **ENTER** hard key.
 - d. Press the **RBW** soft key.
 - e. Enter a value by using the numeric keys.
 - f. Select the unit: **GHz**, **MHz**, **kHz**, or **Hz**.
 - g. Press the **VBW** soft key.
 - h. Enter a value by using the numeric keys.
 - i. Select the unit: **GHz**, **MHz**, **kHz**, or **Hz**.
 6. Press the **PREV** hard key.
 7. Toggle the **Measure Type** soft key between **Examine** and **Full** to select the measurement type.
- NOTE**
The **Examine** mode displays only the selected range while the **Full** mode lets the instrument automatically changes the selected range from one another.
8. Set the number of measurements to be averaged:
 - a. Press the **Average** soft key.
 - b. Enter a value between 1 and 100.
 - c. Press the **Enter** soft key.

After configuring test parameters as described in the “Configuring test parameters” on page 346, your measurement result is displayed on the screen as like the following example, Figure 172.

Figure 172 Spurious emissions measurement with EV-DO signal analyzer



NOTE

You can use the **LIMIT** hot key to analyze your measurements with the user-definable limit and Pass/Fail indication. See “Setting limit for RF tests” on page 358 for more information.

Setting limit for RF tests

By default, test limits specified in the standard are set for you. You can change thresholds if you desire.

Procedure

1. Press the **LIMIT** hot key.
2. Press the **RF Test Limits** soft key.
3. Select the test item(s) and set the limit(s) depending on your selected measurement mode:

To set the limit for	Select	Set
Channel power	Channel Power	High Limit Low Limit
Occupied bandwidth	Occupied BW	High Limit
Spectrum emission mask	Spectrum Emission Mask	(On/Off only)
ACPR	ACPR	(On/Off only)
Multi-ACPR	Multi-ACPR	(On/Off only)
Spurious emissions	Spurious Emissions	(On/Off only)

4. *Optional.* You can enable alarm sound that goes off if the measurement falls outside of the limit. Toggle the **Beep** soft key between **On** and **Off** to enable or disable the beep sound.
5. *Optional.* Go to **SAVE/LOAD > Save**, and then select **Limit** to save the limit settings. See “Using save” on page 31 for more information.

Conducting power vs. time measurements

The Power vs. Time (Idle Slot and Active Slot) in EV-DO Signal Analyzer verifies that the transmitter output power has correct amplitude, shape, and timing for the EV-DO format.

- Idle Slot: Slot with no data in traffic channel.
- Active Slot: Slot with the loaded data in traffic channel.

Forward link of 1xEV-DO is a frame structure and each frame consists of 16 slots. The frame period for 1xEV-DO is 26.667 ms, which is also the period of one pilot channel. Each frame is divided into 16 slots of 1.666 ms. 1xEV-DO uses CDMA modulation scheme, but unlike its previous systems the Pilot, MAC (Media Access Control), and Data (Traffic) Channel are not transmitted simultaneously; instead they are transmitted in TDM (Time Division Multiplex).

Power vs. time (idle slot)

The Power vs. Time (Idle Slot) measurement provides the idle slot that includes the Pilot and MAC channels with the masks in all regions.

After configuring test parameters as described in the “Configuring test parameters” on page 346, your measurement result is displayed on the screen as like the following example, Figure 173.

Figure 173 Power vs. time (idle slot) measurement with EV-DO signal analyzer



NOTE

You can use the **LIMIT** hot key to analyze your measurements with the user-definable limit and Pass/Fail indication. See “Setting limit for power vs. time tests” on page 360 for more information.

Power vs. time (active slot)

The Power vs. Time (Active Slot) measurement includes the Pilot, MAC, and Data channels with the upper and lower masks.

After configuring test parameters as described in the “Configuring test parameters” on page 346, your

measurement result is displayed on the screen as like the following example, Figure 174.

Figure 174 Power vs. time (active slot) measurement with EV-DO signal analyzer



NOTE

You can use the **LIMIT** hot key to analyze your measurements with the user-definable limit and Pass/Fail indication. See “Setting limit for power vs. time tests” on page 360 for more information.

Setting limit for power vs. time tests

Procedure

1. Press the **LIMIT** hot key.
2. Press the **PvsT Test Limits** soft key.
3. Select the test item(s) and set the limit(s):

To set the limit for	Select	Set
Pilot power	Pilot Power	High Limit Low Limit
Medium access control power	MAC Power	High Limit Low Limit
Data power during the data period	Data Power	High Limit Low Limit
On/off power ratio of the pilot and MAC powers to the data power	On/Off Ratio	Low Limit

4. *Optional.* You can enable alarm sound that goes off if the measurement falls outside of the limit. Toggle the **Beep** soft key between **On** and **Off** to enable or disable the beep sound.
5. *Optional.* Go to **SAVE/LOAD > Save**, and then select **Limit** to save the limit settings. See “Using save” on page 31 for more information.

Conducting modulation measurements

In order to make accurate measurements of time offset and PN, you must connect an external trigger before making a modulation measurement.

Constellation

The Constellation is used to observe some aspects of modulation accuracy and can reveal certain fault mechanisms such as I/Q amplitude imbalance or quadrature imbalance. It displays constellation diagram by modulation types.

Setting measure setup

After configuring test parameters as described in the “Configuring test parameters” on page 346, you can continue your measurement. The measurement settings can be saved and recalled as a file. You can also use JDViewer, PC application software to configure a measure setup, save as a file, and load the file on to the instrument.

Procedure

1. Press the **MEASURE SETUP** hot key.
 2. To set the Pseudo-Noise (PN) offset, complete the following steps:
 - a. Toggle the **PN Offset** soft key between **Auto** and **Manual**.
 - b. Enter a value by using the numeric keys to set manually.
 - c. Press the **Enter** soft key.
 3. To set the incremental step for the PN offset, complete the following steps:
 - a. Press the **PN Increment** soft key.
 - b. Enter a value by using the numeric keys.
 - c. Press the **Enter** soft key.
 4. Press the **Detect Mode** soft key, and then select the detection mode option: **Auto**, **QPSK**, **8PSK**, **16 QAM**, or **64 QAM**.
 5. *Optional.* Go to **SAVE/LOAD > Save**, and then select the save option from the choices available for your measurement mode. See “Using save” on page 31 for more information.
-

NOTE

You can use the **LIMIT** hot key to analyze your measurements with the user-definable limit and Pass/Fail indication. See “Setting limit for modulation tests” on page 370 for more information. *The Max Inactive is not used in the Constellation mode.*

Measurement example

Figure 175 Constellation measurement with EV-DO signal analyzer

1) Composite 64

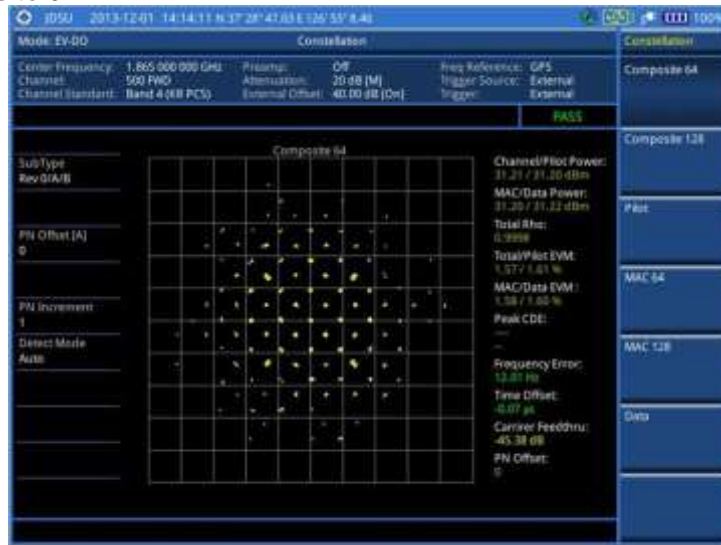

2) Composite 128



3) Pilot



4) MAC 64



5) MAC 128



6) Data



Code domain power

The Code Domain Power (CDP) measures the distribution of power across the set of code channels, normalized to the total EV-DO power. It helps to verify that each code channel is operating at its proper level and to identify problems throughout the transmitter design from coding to the RF section. System imperfections such as amplifier non-linearity will present themselves as an undesired distribution of power in the code domain.

Setting measure setup

After configuring test parameters as described in the “Configuring test parameters” on page 346, you can continue your measurement. The measurement settings can be saved and recalled as a file. You can also use JDViewer, PC application software to configure a measure setup, save as a file, and load the file on to the instrument.

Procedure

1. Press the **MEASURE SETUP** hot key.
2. To set the Pseudo-Noise (PN) offset, complete the following steps:
 - a. Toggle the **PN Offset** soft key between **Auto** and **Manual**.
 - b. Enter a value by using the numeric keys to set manually.
 - c. Press the **Enter** soft key.
3. To set the incremental step for the PN offset, complete the following steps:
 - a. Press the **PN Increment** soft key.
 - b. Enter a value by using the numeric keys.
 - c. Press the **Enter** soft key.
4. To set the threshold between Auto and Manual, complete the following steps:
 - a. Press the **Threshold** soft key. Its default setting is -27 dB.
 - b. Enter a value between -50 and zero by using the numeric keys to change the value in the Manual mode.
 - c. Press the **Enter** soft key.

5. Press the **Detect Mode** soft key, and then select the detection mode option: **Auto**, **QPSK**, **8PSK**, **16 QAM**, or **64 QAM**.
6. *Optional.* Go to **SAVE/LOAD > Save**, and then select the save option from the choices available for your measurement mode. See “Using save” on page 31 for more information.

NOTE
 You can use the **LIMIT** hot key to analyze your measurements with the user-definable limit and Pass/Fail indication for the Max Inactive. See “Setting limit for modulation tests” on page 370 for more information.

Measurement example

Figure 176 Code domain power measurement with EV-DO signal analyzer

1) Pilot



2) MAC 64



3) MAC 128



4) Data



MAC Codogram

The MAC Codogram displays the power variation for every code over time, presenting a clear view of the traffic load per channels at any given time. The MAC Codogram measurements can be saved into an external USB memory so that a post-analysis can be done with the application software JDViewer.

Setting measure setup

After configuring test parameters as described in the “Configuring test parameters” on page 346, you can continue your measurement. The measurement settings can be saved and recalled as a file. You can also use JDViewer, PC application software to configure a measure setup, save as a file, and load the file on to the instrument.

Procedure

1. Press the **MEASURE SETUP** hot key.
2. To set the Pseudo-Noise (PN) offset, complete the following steps:

- a. Toggle the **PN Offset** soft key between **Auto** and **Manual**.
 - b. Enter a value by using the numeric keys to set manually.
 - c. Press the **Enter** soft key.
3. To set the incremental step for the PN offset, complete the following steps:
 - a. Press the **PN Increment** soft key.
 - b. Enter a value by using the numeric keys.
 - c. Press the **Enter** soft key.
 4. To set the threshold between Auto and Manual, complete the following steps:
 - a. Press the **Threshold** soft key. Its default setting is -27 dB.
 - b. Enter a value between -50 and zero by using the numeric keys to change the value in the Manual mode.
 - c. Press the **Enter** soft key.
 5. Toggle the **MAC** soft key and select the MAC Walsh code option: **64** or **128**.
 6. To set the time interval, complete the following steps:
 - a. Press the **Time Interval** soft key.
 - b. Enter a value by using the numeric keys.
 - c. Press the **Enter** soft key.
 7. To place the time cursor to analyze your measurements, complete the following steps:
 - a. Toggle the **Time Cursor** soft key between **On** and **Off** to enable or disable the time cursor.
 - b. Enter a value by using the numeric keys.
 - c. Press the **Enter** soft key.

NOTE

When the time cursor is enabled, the measurement is put on hold and information about the time cursor is displayed.

8. *Optional.* Go to **SAVE/LOAD > Save**, and then select the save option from the choices available for your measurement mode. See “Using save” on page 31 for more information.

Measurement example

Figure 177 MAC Codogram in full view with EV-DO signal analyzer

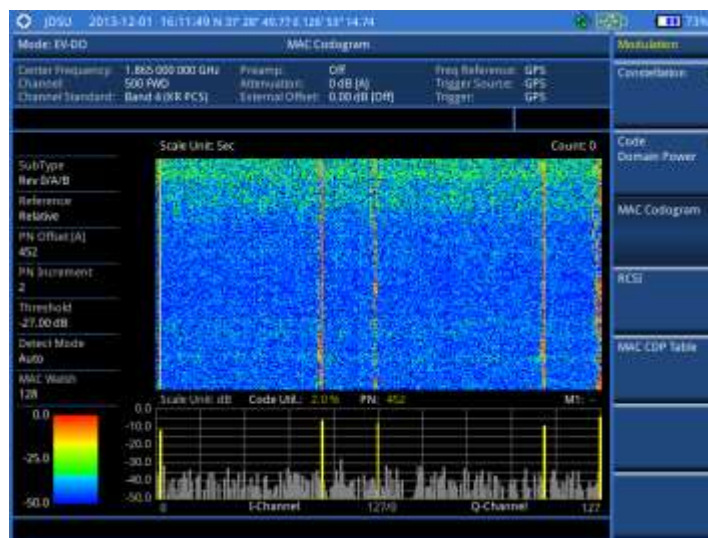

RCSI

The Received Code Strength Indicator (RCSI) is used to track the power variation over time of EV-DO channels: Pilot, MAC, Data, and Slot. The RCSI measurements can be saved into an external USB memory so that a post-analysis can be done with the application software JDViewer.

Setting measure setup

After configuring test parameters as described in the “Configuring test parameters” on page 346, you can continue your measurement. The measurement settings can be saved and recalled as a file. You can also use JDViewer, PC application software to configure a measure setup, save as a file, and load the file on to the instrument.

Procedure

1. Press the **MEASURE SETUP** hot key.
 2. To set the Pseudo-Noise (PN) offset, complete the following steps:
 - a. Toggle the **PN Offset** soft key between **Auto** and **Manual**.
 - b. Enter a value by using the numeric keys to set manually.
 - c. Press the **Enter** soft key.
 3. To set the incremental step for the PN offset, complete the following steps:
 - a. Press the **PN Increment** soft key.
 - b. Enter a value by using the numeric keys.
 - c. Press the **Enter** soft key.
 4. To set the threshold between Auto and Manual, complete the following steps:
 - a. Press the **Threshold** soft key. Its default setting is -27 dB.
 - b. Enter a value between -50 and zero by using the numeric keys to change the value in the Manual mode.
 - c. Press the **Enter** soft key.
 5. Toggle the **MAC** soft key and select the MAC Walsh code option: **64** or **128**.
 6. Press the **Alarm Code** soft key, and then select the alarm code option: **None**, **Pilot**, **MAC**, **Data**, or **Slot**.
 7. To set the alarm mask, complete the following steps:
 - a. Press the **Set Mask** soft key.
 - b. Enter a value by using the numeric keys.
 - c. Press the **[dB|dBm]** soft key.
 8. *Optional.* Go to **SAVE/LOAD > Save**, and then select the save option from the choices available for your measurement mode. See “Using save” on page 31 for more information.
-

Measurement example

Figure 178 RCSI measurement with EV-DO signal analyzer



MAC CDP Table

The MAC CDP Table is used for the user to look at a numeric and textual description of all the active control channels in the signal.

Setting measure setup

After configuring test parameters as described in the “Configuring test parameters” on page 346, you can continue your measurement. The measurement settings can be saved and recalled as a file. You can also use JDViewer, PC application software to configure a measure setup, save as a file, and load the file on to the instrument.

Procedure

1. Press the **MEASURE SETUP** hot key.
2. To set the Pseudo-Noise (PN) offset, complete the following steps:
 - a. Toggle the **PN Offset** soft key between **Auto** and **Manual**.
 - b. Enter a value by using the numeric keys to set manually.
 - c. Press the **Enter** soft key.
3. To set the incremental step for the PN offset, complete the following steps:
 - a. Press the **PN Increment** soft key.
 - b. Enter a value by using the numeric keys.
 - c. Press the **Enter** soft key.
4. To set the threshold between Auto and Manual, complete the following steps:
 - a. Press the **Threshold** soft key. Its default setting is -27 dB.
 - b. Enter a value between -50 and zero by using the numeric keys to change the value in the Manual mode.
 - c. Press the **Enter** soft key.
5. Toggle the **MAC** soft key and select the MAC Walsh code option: **64** or **128**.

Measurement example

Figure 179 MAC CDP Table measurement with EV-DO signal analyzer



Setting display

If the MAC CDP table spans over to the next page(s), you can change pages up and down to view .your measurement results.

Procedure

1. Press the **TRACE/DISPLAY** hard key.
2. Select **Page Up** or **Page Down** as needed to scroll the screen up and down.

Setting limit for modulation tests

Procedure

1. Press the **LIMIT** hot key.
2. Press the **Modulation Test Limits** soft key.
3. Select the test item(s) and set the limit(s) depending on your selected measurement mode:

To set the limit for	Select	Set
Frequency error	Frequency Error	High Limit Low Limit
Time offset	Time Offset	High Limit Low Limit
Carrier feed through	Carrier Feed Through	High Limit
Highest level among inactive channels	Max Inactive	High Limit
Waveform quality (Rho) for pilot	Pilot Rho	Low Limit
Waveform quality (Rho) for MAC	MAC Rho	Low Limit
Waveform quality (Rho) for data	Data Rho	Low Limit

4. *Optional.* You can enable alarm sound that goes off if the measurement falls outside of the limit. Toggle the **Beep** soft key between **On** and **Off** to enable or disable the beep sound.
5. *Optional.* Go to **SAVE/LOAD > Save**, and then select **Limit** to save the limit settings. See “Using save” on page 31 for more information.

NOTE

The Time Offset compares the PN offset timing with the overall system time and the instrument checks the start of PN offset in comparison to either the GPS signal or the even second clock signal.

NOTE

The Carrier Feed Through is a result of the RF carrier signal feeding through the I/Q modulator and riding on the output circuitry without being modulated.

Performing auto measurements

The Auto Measure function of the JD780A series allows a complete signal profiling covering RF characterization and modulation quality parameters of up to 10 different carriers, particularly useful on an overlay architecture where base stations are transmitting in different frequencies.

The Auto Measure can be easily executed either by selecting a menu in the instrument or by running a programmed scenario in the PC-based application so that the instrument automatically configure and perform tests on every aspect of all the carriers.

Setting limit for auto measure

You can set test limits for test item(s) in the auto measurement.

Procedure

1. Press the **LIMIT** hot key.
 2. Press the **RF Test Limits** soft key, and then enable test limits as desired.
 3. Press the **PvsT Test Limits** soft key, and then enable test limits as desired.
 4. Press the **Modulation Test Limits** soft key, and then enable test limits as desired.
 5. *Optional.* You can enable alarm sound that goes off if the measurement falls outside of the limit. Toggle the **Beep** soft key between **On** and **Off** to enable or disable the beep sound.
 6. *Optional.* Go to **SAVE/LOAD > Save**, and then select **Limit** to save the limit settings. See “Using save” on page 31 for more information.
-

Setting measure setup

After configuring test parameters as described in the “Configuring test parameters” on page 346, you can continue your measurement. The measurement settings can be saved and recalled as a file. You can also use JDViewer, PC application software to configure a measure setup, save as a file, and load the file on to the instrument.

Procedure

1. Press the **MEASURE SETUP** hot key.
 2. Toggle the **Configuration** soft key and select the configuration option:
-

-
- **Current:** to let the instrument use current frequency (single carrier) and determine pass or fail based on the instrument's limit settings in Auto Measure.
 - **Scenario:** to run a test with a programmed scenario in JDViewer. The Scenario menu becomes activated.
3. To load a scenario, press the **Scenario** soft key, and then select a scenario file to load.
 4. Toggle the **Test Time** soft key and select the test time option:
 - **Now:** to let the instrument run a test only once.
 - **Schedule:** to let the instrument repeat tests as defined in the Set Timing. The Set Timing menu becomes activated.
 5. To define a schedule for an auto measurement, complete the following steps:
 - a. Press the **Set Timing** soft key.
 - b. Press the **Start Time (HH:MM)** soft key.
 - c. Enter the time in the HH:MM format, and then press the **Enter** soft key.
 - d. Press the **Stop Time (HH:MM)** soft key.
 - e. Enter the time in the HH:MM format, and then press the **Enter** soft key.
 - f. Press the **Time Interval** soft key.
 - g. Enter the amount of time in minutes, and then press the **Enter** soft key.
 6. Press the **Settings** soft key, and then set the following:
 - a. Toggle the **MAC** soft key and select the MAC Walsh code option: **64** or **128**.
 - b. Toggle the **PvsT** soft key and select the slot option: **Idle** or **Active**.
 - c. Toggle the **External Offset** soft key and select **On**.
 - d. Enter a value by using the numeric keys, and then press the **dB** soft key.
 7. To save your settings and results, go to **SAVE/LOAD > Save** and then perform functions as you desire. See "Using save" on page 31 for more information.
 8. Press the **Run Test** soft key to start to run a test. The Auto Measure Results window appears at the end of the test.
 9. To stop running the test, press the **Abort** soft key.
 10. To change the view on the screen during the test, press the **Display** and then select the view option from the following choices:
 - **Screen:** You can view each measurement screen as the test progresses.
 - **Results:** You can view a measurement result table as the test progresses.
 - **Settings:** You can view a measurement setting table as the test progresses.
-

Setting display

After completion of the auto measurement, the screen menu changes to Trace/Display so that you can view the results in different forms.

Procedure

1. Toggle the **Display** soft key and select the display option:
 - **Result:** to view the result table. The Display Result menu becomes activated.
 - **Settings:** to view the measurement settings for the auto measurement.
-

2. Toggle the **Display Result** soft key and select the display result option:
 - **Full**: to view detailed measurement readings with the pass/fail indication.
 - **Quick**: to view only the Pass/Fail results.
3. To view the measurement results for a different carrier, press the **View Carrier** soft key and then select the carrier number to view.

Performing power statistics CCDF measurements

The Power Statistics Complementary Cumulative Distribution Function (CCDF) measurement characterizes the power statistics of the input signal. It provides PAR (Peak to Average power Ratio) versus different probabilities.

Setting measure setup

After configuring test parameters as described in the “Configuring test parameters” on page 346, you can continue your measurement. The measurement settings can be saved and recalled as a file. You can also use JDViewer, PC application software to configure a measure setup, save as a file, and load the file on to the instrument.

Procedure

1. Press the **MEASURE SETUP** hot key.
2. Press the **CCDF Length** soft key to set the length of the CCDF.
3. Enter a value between 1 and 100 by using the numeric keys. You can also use the rotary knob.
4. Press the **Enter** soft key.

Measurement example

Figure 180 CCDF measurement with EV-DO signal analyzer



Conducting EV-DO OTA measurements

This Over The Air (OTA) measurement has channel scanner, PN scanner, multipath profile, and Code Domain power screens. It is used to verify EV-DO transmitter performance at any location providing reflective measurements and identifying signals providing from different sites. The Code Domain power shows not only modulation performance metric but also amplifier capacity and code utilization metric. The Amplifier capacity (code utilization) measurement is an estimate of the amount of power amplifier capacity (code utilization) that is being used expressed in percent of maximum.

Channel scanner

Setting channel/frequency

Procedure

To set the channels to be scanned:

1. Press the **FREQ/DIST** hard key.
2. Toggle the **Unit** soft key and select **Channel**.
3. Press the **Index** soft key, and then enter an index number between one and six by turning the rotary knob or using the numeric keys.
4. To select the standard channel, complete the following steps:
 - a. Press the **Channel Std** soft key. The standard channel window appears. See "Appendix C – Band, frequency & channel standard" on page 541 for more information.
 - b. Select the band to be measured by using the rotary knob, the arrow keys, or the **Page Up/Page Down** soft keys.
 - c. Press the **Select** soft key or the rotary knob to confirm the selection.
5. To set the channel number for the selected index, complete the following steps:
 - a. Press the **Channel Number** soft key.
 - b. Enter a value by using the numeric keys. You can also use the rotary knob.
 - c. Press the **Enter** soft key.

The instrument displays a corresponding center frequency for the channel number.
6. To set the integration bandwidth for the selected index, complete the following steps:
 - a. Press the **Integration Bandwidth** soft key.
 - b. Enter a value by using the numeric keys. You can also use the rotary knob.
 - c. Select the unit: **GHz**, **MHz**, **kHz**, or **Hz**.
7. To add more channels to be scanned, repeat steps 3-6.
8. Press the **ESC** hard key to dismiss the channel list window and view the scanning result.

To set the frequencies to be scanned:

1. Press the **FREQ/DIST** hard key.
 2. Toggle the **Unit** soft key and select **Freq**.
 3. Press the **Index** soft key, and then enter an index number between one and six by turning the rotary knob or using the numeric keys.
 4. To set the center frequency for the selected index, complete the following steps:
 - a. Press the **Center Frequency** soft key.
 - b. Enter a value by using the numeric keys. You can also use the rotary knob.
 - c. Select the unit: **GHz**, **MHz**, **kHz**, or **Hz**.
-

-
5. To set the integration bandwidth for the selected index, complete the following steps:
 - a. Press the **Integration Bandwidth** soft key.
 - b. Enter a value by using the numeric keys. You can also use the rotary knob.
 - c. Select the unit: **GHz**, **MHz**, **kHz**, or **Hz**.
 6. To add more channels to be scanned, repeat steps 3-5.
 7. Press the **ESC** hard key to dismiss the channel list window and view the scanning result.
-

Setting measure setup

After configuring other test parameters as described in the “Configuring test parameters” on page 346, you can continue your measurement. The measurement settings can be saved and recalled as a file. You can also use JDViewer, PC application software to configure a measure setup, save as a file, and load the file on to the instrument.

Procedure

1. Press the **MEASURE SETUP** hot key.
 2. To set the incremental step for the PN offset, complete the following steps:
 - a. Press the **PN Increment** soft key.
 - b. Enter a value by using the numeric keys.
 - c. Press the **Enter** soft key.
 3. *Optional.* Go to **SAVE/LOAD > Save**, and then select the save option from the choices available for your measurement mode. See “Using save” on page 31 for more information.
-

Setting limit for OTA channel scanner

Procedure

1. Press the **LIMIT** hot key.
 2. Press the **Limit Line** soft key to set a threshold for the limit line and Pass/Fail indication.
 3. Enter a value, and then press the **dBm** unit soft key.
 4. Toggle the **Limit Line** soft key between **On** and **Off** to display or dismiss the limit line.
 5. *Optional.* You can enable alarm sound that goes off if the measurement falls outside of the limit. Toggle the **Beep** soft key between **On** and **Off** to enable or disable the beep sound.
 6. *Optional.* Go to **SAVE/LOAD > Save**, and then select **Limit** to save the limit settings. See “Using save” on page 31 for more information.
-

Measurement example

Figure 181 Channel scanner measurement with EV-DO OTA signal analyzer



PN scanner

Each access network sector has a unique PN offset. The PN Scanner is used to identify all the active PNs in an area.

Setting measure setup

After configuring test parameters as described in the “Configuring test parameters” on page 346, you can continue your measurement. The measurement settings can be saved and recalled as a file. You can also use JDViewer, PC application software to configure a measure setup, save as a file, and load the file on to the instrument.

Procedure

1. Press the **MEASURE SETUP** hot key.
2. To set the incremental step for the PN offset, complete the following steps:
 - a. Press the **PN Increment** soft key.
 - b. Enter a value by using the numeric keys.
 - c. Press the **Enter** soft key.
3. *Optional.* Go to **SAVE/LOAD > Save**, and then select the save option from the choices available for your measurement mode. See “Using save” on page 31 for more information.

Measurement example

Figure 182 PN scanner measurement with EV-DO OTA signal analyzer



Multipath profile

The Multipath Profile enables you to determine RF environmental conditions of testing area. It indicates the amount of power of the dominant pilot signal that is dispersed outside the main correlation peak due to multipath echoes that are expressed in dB. This value should be very small ideally.

The multipath profile is the result of portions of the original broadcast signal arriving at the receiving antenna out of phase. This can be caused by the signal being reflected off objects such as buildings, or being refracted through the atmosphere differently from the main signal.

Setting measure setup

After configuring test parameters as described in the “Configuring test parameters” on page 346, you can continue your measurement. The measurement settings can be saved and recalled as a file. You can also use JDViewer, PC application software to configure a measure setup, save as a file, and load the file on to the instrument.

Procedure

1. Press the **MEASURE SETUP** hot key.
2. To set the incremental step for the PN offset, complete the following steps:
 - a. Press the **PN Increment** soft key.
 - b. Enter a value by using the numeric keys.
 - c. Press the **Enter** soft key.
3. *Optional.* Go to **SAVE/LOAD > Save**, and then select the save option from the choices available for your measurement mode. See “Using save” on page 31 for more information.

Measurement example

Figure 183 Multipath profile measurement with EV-DO OTA signal analyzer



Code domain power

Channels with high correlation factors are determined to be active channels and are indicated as such on the display. Once the channels are decoded, the analyzer determines the power of each channel relative to the total signal power.

This measurement helps to verify that each code channel is operating at its proper level and helps to identify problems throughout the transmitter design from the coding to the RF section. System imperfections, such as the non-linearity of amplifiers, will present themselves as an undesired distribution of power in the code domain.

Setting measure setup

After configuring test parameters as described in “Configuring test parameters” on page 346, you can continue your measurement. The measurement settings can be saved and recalled as a file. You can also use JDViewer, PC application software to configure a measure setup, save as a file, and load the file on to the instrument.

Procedure

1. Press the **MEASURE SETUP** hot key.
 2. To set the Pseudo-Noise (PN) offset, complete the following steps:
 - a. Toggle the **PN Offset** soft key between **Auto** and **Manual**.
 - b. Enter a value by using the numeric keys to set manually.
 - c. Press the **Enter** soft key.
 3. To set the incremental step for the PN offset, complete the following steps:
 - a. Press the **PN Increment** soft key.
 - b. Enter a value by using the numeric keys.
 - c. Press the **Enter** soft key.
-

4. To set the threshold between Auto and Manual, complete the following steps:
 - a. Press the **Threshold** soft key. Its default setting is -27 dB.
 - b. Enter a value between -50 and zero by using the numeric keys to change the value in the Manual mode.
 - c. Press the **Enter** soft key.
5. Toggle the **MAC** soft key and select the MAC Walsh code option: **64** or **128**.
6. Press the **Detect Mode** soft key, and then select the detection mode option: **Auto**, **QPSK**, **8PSK**, **16 QAM**, or **64 QAM**.
7. To set the threshold for pilot dominance, complete the following steps:
 - a. Press the **Pilot Dominance >** soft key.
 - b. Enter a value by using the numeric keys.
 - c. Press the **Enter** soft key.

NOTE
Recommended value is 10. Color of the Pilot Dominance indicator on the screen bases on this setting.

8. To set the threshold for multipath power, complete the following steps:
 - a. Press the **Multipath Power <** soft key.
 - b. Enter a value by using the numeric keys.
 - c. Press the **Enter** soft key.

NOTE
Recommended value is one. Color of the multipath power indicator on the screen bases on this setting.

9. *Optional.* Go to **SAVE/LOAD > Save**, and then select the save option from the choices available for your measurement mode. See “Using save” on page 31 for more information.

Measurement example

Figure 184 Code domain power measurement with EV-DO OTA signal analyzer



NOTE

You can use the **LIMIT** hot key to analyze your measurements with the user-definable limit and Pass/Fail indication.

Route map

The JD780A Series provides indoor and outdoor mapping function that allows a user to collect data of points in an indoor or outdoor environment and track the received signals and coverage of RF transmitters plotting real time directly on top of a loaded floor plan or a map.

Setting measure setup

Procedure

1. If required, connect a GPS receiver to your JD780A series for outdoor mapping. Indoor mapping does not necessarily need a GPS antenna.
2. Configure test parameters as described in the “Configuring test parameters” on page 346.
3. To load your map file, complete the following steps:
 - a. Plug in your USB drive that has a floor map or `.mcf` file type created in JDMapCreator.

NOTE

The JDMapCreator converts and resizes any scanned floor plan or layout to fit onto your instrument’s display. You must save your map files (`.mcf`) into the “**SavedMap**” folder of your USB drive so that you can load them onto your instrument.

- b. Press **SAVE/LOAD** hot key, and then select **Load > Load Map**. See “Using load” on page 34 for more information.
4. Press the **MEASURE SETUP** hot key.
5. Press the **Plot Point** soft key, and then select the plot point option from the following choices:
 - To collect data/plot points automatically as you move around in a vehicle or outside, press the **GPS** soft key and then toggle the **Screen Mode** soft key between **Map** and **Full**.

NOTE

With the **Map** setting, you can view only the collected points that can be seen within the boundary of the loaded map. If a point is off the map, the instrument displays an arrow to indicate the direction of the current location on the map and the distance from the center to the location at the top of the screen.

With the **Full** setting, you can view all the collected points of the route without the loaded map.

- To collect data/plot points manually without a GPS antenna in an indoor environment, press the **Position** soft key.
6. Press the **Plot Item** soft key, and then select the measurement option: **Pilot Power** or **Ec/Io**.
 7. To set the incremental step for the PN offset, complete the following steps:
 - a. Press the **PN Increment** soft key.
 - b. Enter a value by using the numeric keys.
 - c. Press the **Enter** soft key.
 8. Toggle the **Plot** soft key and select **Start**.
 9. Touch directly on the screen or press the **ENTER** hard key to collect data and plot points on the loaded map for the **Position** setting.

NOTE

For the **Position** setting, you can change the direction of the route with the arrow keys and the distance with the rotary knob.

-
10. Toggle the **Plot** soft key and select **Stop** to stop plotting.
 11. Press the **SAVE/LOAD** hot key to save the result.
See "Using save" on page 31 for more information.

NOTE

The instrument does not automatically save the collected data. It is recommended that you save the result. Otherwise, you will lose all the collected data.

Setting limit

You can set the thresholds for the four different color indicators for Pilot power or Ec/Io.

Procedure

1. Press the **LIMIT** hot key.
 2. To set the limits for pilot power if you have selected Pilot for the plot item, complete the following steps:
 - a. Press the **Pilot Power** soft key.
 - b. Press the **Excellent** soft key to set its threshold.
 - c. Enter a value, and then press the **dBm** soft key. You can also use the rotary knob.
 - d. Press the **Very Good** soft key to set its threshold.
 - e. Enter a value, and then press the **dBm** soft key. You can also use the rotary knob.
 - f. Press the **Good** soft key to set its threshold.
 - g. Enter a value, and then press the **dBm** soft key. You can also use the rotary knob.
 - h. Press the **Fair** soft key to set its threshold.
 - i. Enter a value, and then press the **dBm** soft key. You can also use the rotary knob.
 - j. Press the **Poor** soft key to set its threshold.
 - k. Enter a value, and then press the **dBm** soft key. You can also use the rotary knob.
 3. To set the limits for Ec/Io if you have selected as for the plot item , complete the following steps:
 - a. Press the **Ec/Io** soft key.
 - b. Press the **Good** soft key to set its threshold.
 - c. Enter a value, and then press the **Enter** soft key. You can also use the rotary knob.
 - d. Press the **Fair** soft key to set its threshold.
 - e. Enter a value, and then press the **Enter** soft key. You can also use the rotary knob.
 - f. Press the **Poor** soft key to set its threshold.
 - g. Enter a value, and then press the **Enter** soft key. You can also use the rotary knob.
 4. *Optional.* Go to **SAVE/LOAD > Save**, and then select **Limit** to save the limit settings.
See "Using save" on page 31 for more information.
-

Measurement example

Figure 185 Route map measurement with EV-DO OTA signal analyzer

1) Pilot Power



2) Pilot Ec/Io



Using TD-SCDMA Signal Analyzer

This chapter provides instructions for using the TD-SCDMA Signal Analyzer function (option 025) with the TD-SCDMA OTA Analyzer function (option 045). Topics discussed in this chapter are as follows:

■ Introduction	384
■ Display overview	385
■ Connecting a cable	385
■ Selecting measurement mode	387
■ Configuring test parameters	387
■ Conducting spectrum measurements	392
■ Conducting RF measurements	394
■ Conducting power vs. time measurements	402
■ Conducting modulation measurements	408
■ Performing auto measurements	414
■ Conducting TD-SCDMA OTA measurements	416

Introduction

The Time Division-Synchronous Code Division Multiple Access, also known as TD-SCDMA, is a 3G mobile telecommunications standard that is pursued by the Chinese Academy of Telecommunications Technology (CATT) in the People's Republic of China. The TD-SCDMA uses the TDD scheme while the WCDMA uses the FDD.

This TD-SCDMA Signal Analyzer can be used for testing of TD-SCDMA systems, made according to the following standard documentation.

- 3GPP TS 25.105 Base Station radio transmission and reception (TDD)
- 3GPP TS 25.142 Base Station conformance testing (TDD)
- 3GPP TS 25.222 Multiplexing and channel coding (TDD)
- 3GPP TS 25.223 Spreading and modulation (TDD)

The instrument automatically makes standard defined measurements using the measurement methods and limits as defined in the standard. The detailed results allow you to analyze TD-SCDMA/HSDPA system performance. You may alter the measurement parameters for specialized analysis. Pass/Fail testing with standard defined or user defined upper and lower limits and the Pass/Fail indicator help you to determine base station performance easily.

This instrument provides the following measurement tools for TD-SCDMA system:

- Spectrum Analysis
- RF Analysis
 - Channel Power
 - Occupied Bandwidth
 - Spectrum Emission Mask
 - Adjacent Channel Leakage power Ratio (ACLR)
 - Multi-ACLR
 - Spurious Emissions
- Power vs. Time:
 - Power vs. Time (Slot)
 - Power vs. Time (Frame)
 - Power vs. Time (Mask)
 - Timogram
- Modulation Analysis
 - Constellation
 - Midamble Power
 - Code Power
 - Code Error
- Auto Measure
- Over The Air (OTA)
 - Sync-DL ID Scanner
 - Sync-DL ID vs. Tau
 - Sync-DL ID Multipath
 - Sync-DL ID Analyzer
 - Route Map

Display overview

Figure 186 provides descriptions for each segment of the measurement screen.

Figure 186 TD-SCDMA signal analyzer measurement screen

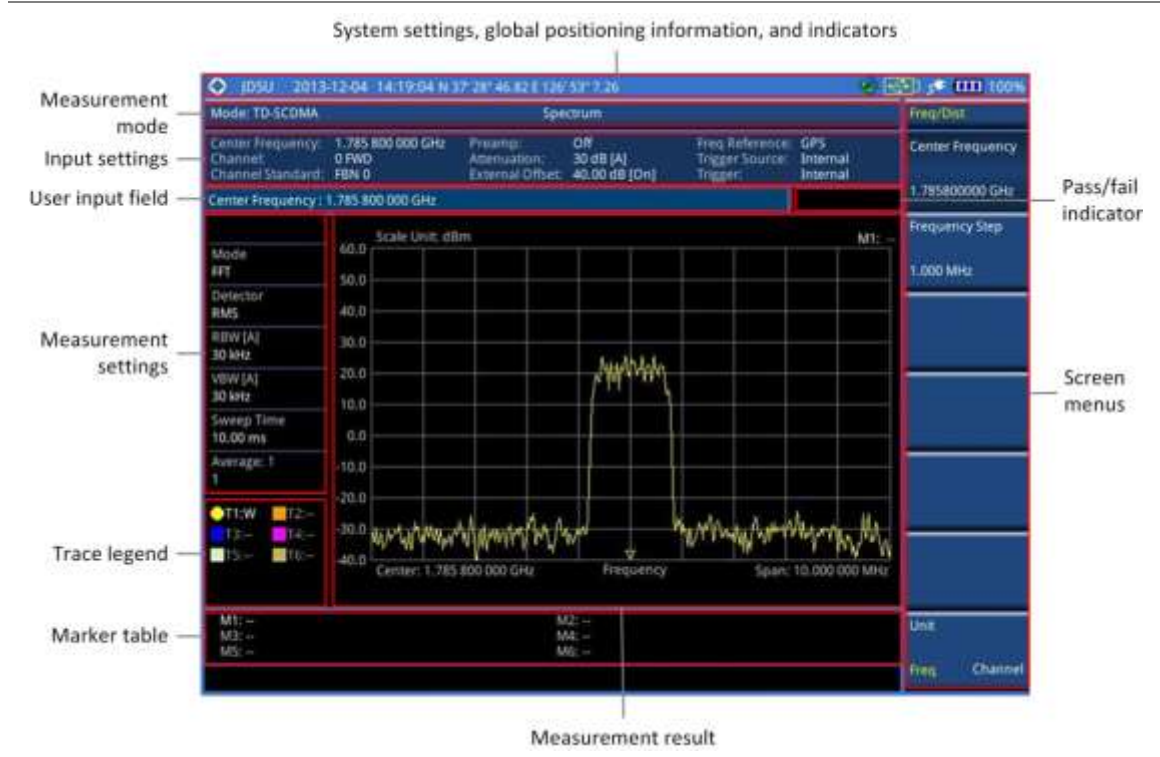

Connecting a cable

Direct connection

Procedure

1. Connect the **Spectrum Analyzer RF In** port of the JD780A series and the Power amplifier output port of BTS.

Figure 187 Direct connection



Indirect connection

Procedure

1. Connect the **Spectrum Analyzer RF In** port of the JD780A series and the monitor (test) port of BTS.

Figure 188 Indirect connection

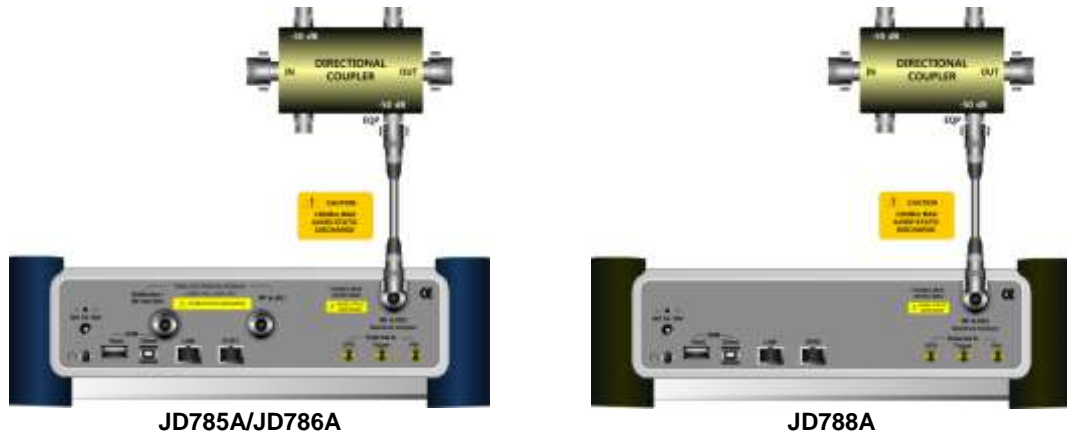

CAUTION

The maximum power for the **Spectrum Analyzer RF In** port is +25 dBm (0.316 W). If the input signal level to be measured is greater than +25 dBm, use a **High Power Attenuator** to prevent damage when you directly connect the signal to the instrument or connect the signal from the coupling port of a directional coupler.

Over the air (OTA)

Procedure

1. Connect an Omni/directional RF antenna to the **Spectrum Analyzer RF In** port of the JD780A series.
2. Connect a GPS antenna to the **GPS** port of the JD780A series.

Figure 189 OTA connection

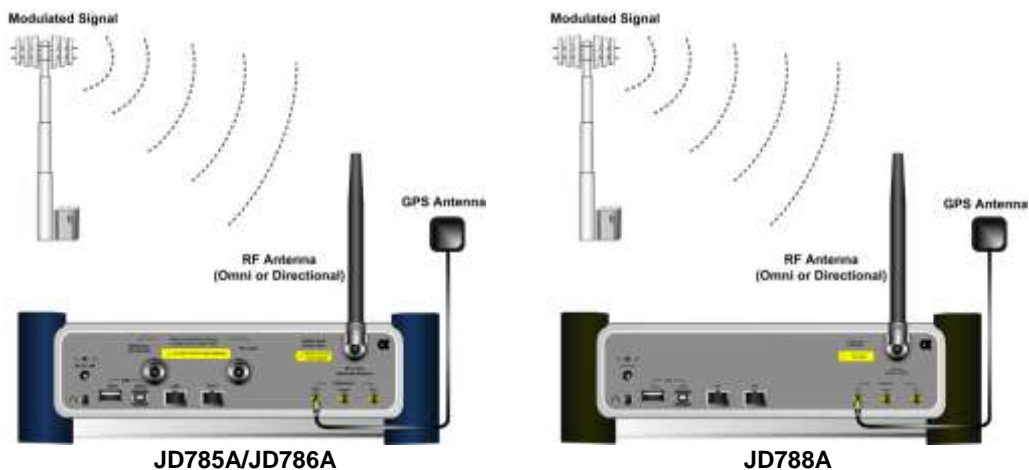

**CAUTION**

If the input signal level to be measured is less than 0 dBm, set 0 dB attenuation or turn on the preamp to have better dynamic range for the OTA testing.

Selecting measurement mode

Procedure

1. Press the **MODE** hard key.
 2. Press the **Signal Analyzer** soft key.
 3. Press the **More (1/2) > TD-SCDMA** soft key. The **Spectrum** mode is set by default.
 4. Press the **MEASURE** hot key, and then select the measurement mode option from the following choices:
 - Spectrum
 - RF Analysis > Channel Power, Occupied BW, Spectrum Emission Mask, ACLR, Multi-ACLR, or Spurious Emissions
 - Power vs Time > Power vs Time (Slot), Power vs Time (Frame), Power vs Time (Frame), or Timogram
 - Modulation Analysis > Constellation, Midamble Power, Code Power, or Code Error
 - Auto Measure
 - OTA > Sync-DL ID Scanner, Sync-DL ID vs Tau, Sync-DL ID Multipath, Sync-DL ID Analyzer, or Route Map
-

Configuring test parameters

Setting frequency

You can set the frequency with either frequency or channel number. If a frequency to be set matches to the frequency corresponding to the selected channel standard, the instrument calculates its channel number and updates the screen with it automatically.

Procedure

To set the center frequency:

1. Press the **FREQ/DIST** hard key.
2. Toggle the **Unit** soft key and select **Freq**.
3. Press the **Center Frequency** soft key.
4. Enter a value by using the numeric keys. You can also use the rotary knob.
5. Select the unit: **GHz**, **MHz**, **kHz**, or **Hz**.
6. *Optional.* To define the amount of frequency increment for the rotary knob, complete the following steps:
 - a. Press the **Frequency Step** soft key.
 - b. Enter a value by using the numeric keys. You can also use the rotary knob.
 - c. Press the unit: **GHz**, **MHz**, **kHz**, or **Hz**.

To set the channel number:

1. Press the **FREQ/DIST** hard key.
2. Toggle the **Unit** soft key and select **Channel**.
3. To select the standard channel, complete the following steps:
 - a. Press the **Channel Std** soft key. The standard channel window appears. See "Appendix C – Band, frequency & channel standard" on page 541 for more information.
 - b. Select the band to be measured by using the rotary knob, the arrow keys, or the **Page Up/Page Down** soft keys.
 - c. Press the **Select** soft key or the rotary knob to confirm the selection.
4. Press the **Channel Number** soft key.
5. Enter a value by using the numeric keys. You can also use the rotary knob.
6. Press the **Enter** soft key.

The instrument automatically displays the corresponding center frequency value for the selected channel number.

7. *Optional.* To define the amount of channel increment for the rotary knob, complete the following steps:
 - a. Press the **Channel Step** soft key.
 - b. Enter a value by using the numeric keys. You can also use the rotary knob.
 - c. Press the **Enter** soft key.

NOTE

This frequency setting is not used in the Multi-ACLR and Spurious Emissions modes.

Setting amplitude

Reference level and attenuation

You can set the reference and attenuation levels automatically or manually to optimize the display of the traces measured, as you desire.

Procedure
To automatically set the reference and attenuation level:

1. Press the **AMP/SCALE** hard key.
2. Press the **Auto Scale** soft key.
Each time you press this key, both of the Y-axis scale and input attenuation level change to be optimized with some margin.

To set the reference or attenuation level manually:

1. Press the **AMP/SCALE** hard key.
2. To set the maximum reference value on the Y-axis manually, complete the following steps:
 - a. Press the **Reference Level** soft key.
 - b. Enter a value by using the numeric keys or the rotary knob with 10 dB increments.
 - c. Press the **dBm** soft key or the **ENTER** hard key.

NOTE

In the measurements such as **Midamble Power**, **Code Power**, and **Code Error**, you may need to select the reference option between **Relative** and **Absolute** before setting the reference level.

3. To set the attenuation option, select one from the following choices:
-

- To set the input attenuator's level automatically, select **Attenuation > Auto**.

NOTE

It is recommended that you set the **Attenuation** to **Auto** in most situations so that the level of the input attenuator can be set automatically according to your input signal level.

- To set the input attenuation manually up to 55 dB to optimize S/N, complete the following steps:
 - a. Select **Attenuation > Manual**.
 - b. Press the **Attenuation Value** soft key to set the level.
 - c. Enter a value between 0 and 55 in fives by using the numeric keys.
 - d. Press the **dB** soft key or the **ENTER** hard key.
- To couple the input attenuator's level with your reference level setting, select **Attenuation > Couple**.
As you increase the reference setting, the attenuation level also increases accordingly.

Optional. To change the scale unit:

1. Select **More (1/2) > Units**.
2. Select the unit of the display scale: **dBm**, **dBV**, **dBmV**, **dBμV**, **V**, or **W**.
The scale unit on the screen changes accordingly.

NOTE

This Units menu is available in the Spectrum and RF Analysis modes.

Scale per division

You can use the **Scale/Div** feature available for the spectrum and RF analysis. It represents the value of one division on the horizontal scale. The default setting is 10 dB per division and the maximum value can be set up to 20 dB.

Procedure

To set the scale per division:

1. Press the **AMP/SCALE** hard key.
 2. Select **More (1/2) > Scale/Div**.
 3. Enter a value between 1 and 20 by using the numeric keys.
 4. Press the **dB** soft key to complete the entry.
-

Pre-amplifier

You can turn the internal pre-amplifier on to correct and compensate for the gain of the preamp so that amplitude readings show the value at the input connector.

Procedure

1. Press the **AMP/SCALE** hard key.
 2. Toggle the **Preamp** soft key and select **On** or **Off** as needed.
-

NOTE

You can turn the Preamp on when the input attenuation range is from 0 dB to 10 dB. If the attenuation value is manually set to greater than 10 dB, the instrument will automatically turn off the pre-amplifier to display low-level signal properly on the chart.

External offset

You can turn the **External Offset** on and manually set the external offset value. An offset consists of a cable loss and a user offset and the measurement result shows the value reflecting both offset values. When the external offset value is set at 40 dB in the Spectrum mode, the measurement result compensates 40 dB at both the Spectrum Analyzer and Signal Analyzer modes

Procedure

To set the external offset:

1. Press the **AMP/SCALE** hard key.
2. Toggle the **External Offset** soft key and select **On**.
3. Enter a value by using the numeric keys.
4. Press the **dB** soft key to complete the entry.

To turn the external offset off:

1. Press the **AMP/SCALE** hard key.
 2. Toggle the **External Offset** soft key and select **Off**.
-

Setting average

You can set the number of measurements to be averaged for the trace presentation in the spectrum and RF analysis. A maximum of 100 times of averaging can be set. When the averaging reaches to your setting, a new measurement value replaces the measurement value in sequence from the earliest.

Procedure

1. Press the **BW/AVG** hard key.
 2. Press the **Average** soft key.
 3. Enter a value between 1 and 100 as needed by using the numeric keys.
 4. Press the **Enter** soft key.
-

Setting sweep mode

The default settings of the sweep mode are **Continue** and **Normal** to sweep continuously at a normal speed for most on-going measurements. If you want to hold the measurement or get a single sweep, you can change the sweep mode.

Procedure

To select the single sweep mode:

1. Press the **SWEEP** hot key.
2. Toggle the **Sweep Mode** soft key and select **Single**. You can also use the **HOLD** hot key. The letter **HOLD** in red appears and the sweeping is paused.
3. *Optional.* Press the **Sweep Once** soft key to get a new measurement.

To return to the continuous sweep mode:

1. Toggle the **Sweep Mode** soft key and select **Continue**. You can also use the **HOLD** hot key. The letter **HOLD** in red disappears and the sweeping resumes.
-

Setting trigger source

You can set the trigger source option for your measurements.

Procedure

1. Press the **TRIGGER** hot key.
 2. Select the trigger source option from the following choices: **Internal**, **External**, or **GPS**.
-

Setting external clock

To enhance the reliability of modulation analysis measurements the JD780A series must be synchronized with a base station. When an external clock is not supplied, the instrument works with its built-in internal high-accuracy time base and some measurement results may exhibit inaccurate values. Therefore, it is highly recommended that you use the same reference clock as the signal source. You can use the **TRIGGER** hot key to set the external clock.







Figure 190 Connection ports for external reference clock



Procedure

1. Connect an external reference or a GPS antenna to the JD780A series.
2. Press the **SYSTEM** hot key.
3. Press the **Freq Reference** soft key, and then select the reference option: **Internal**, **External 10 MHz**, **External 13 MHz**, **External 15 MHz**, or **GPS**.

Table 20 External reference indicators

Type	Indicator	Description
Internal	 (green)	The green INT icon indicates that the instrument uses the built-in internal time base.
External	 (green)	The green EXT icon indicates that an external reference is connected and locked and that the instrument uses the same reference clock as the signal source.
External	 (red)	The red EXT icon indicates that an external reference is connect but not locked.
GPS	 (green)	The green GPS antenna icon indicates that a GPS antenna is connected and locked.
GPS	 (yellow)	The yellow GPS antenna icon indicates that a GPS antenna is connected and locking is in progress.
GPS	 (grey)	The grey GPS antenna icon indicates that a GPS antenna is not connected, failed, or unable to be locked.

Conducting spectrum measurements

Setting measure setup

After configuring test parameters as described in the “Configuring test parameters” on page 387, you can continue your measurement.

Procedure

1. Press the **MEASURE SETUP** hot key.
2. Press the **Slot Number** soft key, and then select the time slot number to be displayed: **TS0**, **TS1**, **TS2**, **TS3**, **TS4**, **TS5**, or **TS6**.
3. *Optional.* To set the delay, complete the following steps:
 - a. Press the **Delay** soft key to set the amount of delay in μ s.

- b. Enter a value by using the numeric keys. You can also use the rotary knob.
- c. Press the **µs** soft key.

NOTE

The Delay setting is used only when there is a time offset in the signals to be measured.

Your measurement result is displayed on the screen as like the following example, Figure 191.

Figure 191 Spectrum measurement screen with TD-SCDMA signal analyzer



Setting trace

You can display up to six traces on the measurement chart simultaneously.

Procedure

1. Press the **TRACE/DISPLAY** hard key.
2. Press the **Select Trace** soft key, and then select the trace number: **T1**, **T2**, **T3**, **T4**, **T5**, or **T6**. The legend shape of the selected trace changes from square to round to indicate that the trace is the active one now.
3. Toggle the **Trace View** soft key and select **On**.
4. To clear, write or capture, or hide the trace(s), do one of the following:

To	Select	Trace Legend
Clear current data and display with new measurements	Clear Write	W
Display the input signal's maximum response only	Max Hold	M
Display the input signal's minimum response only	Min Hold	m
Capture the selected trace and compare traces	Capture	C
Load a saved trace	More (1/2) > Load	L
Hide the selected trace	Trace View > Off	F

Remove all the traces and initialize the trace settings

More (1/2) > Trace
Clear All

5. *Optional.* Press the **More (1/2) > Trace Info** soft key, and then select the trace number to view the trace's parameter setting information stored at the time of the measurement or **None** to hide the information display.
 6. *Optional.* If you have the two traces T1 and T2, you can perform trace math. To view the power difference between the traces, press the **T1 – T2 -> T5** or **T2 – T1 -> T6** soft key. The result is overlaid on the screen along with the second Y-axis.
-

Conducting RF measurements

Channel power

The Channel Power measurement determines the average power of an RF signal burst at or above a specified threshold value.

The purpose of the Channel Power measurement is to determine the power delivered to the antenna system on the RF channel under test. The instrument acquires a TD-SCDMA signal in the time domain. The average power level above the threshold is then computed and displayed.

Setting measure setup

After configuring test parameters as described in the “Configuring test parameters” on page 387, you can continue your measurement.

Procedure

1. Press the **MEASURE SETUP** hot key.
2. Press the **Slot Number** soft key, and then select the time slot number to be displayed: **TS0**, **TS1**, **TS2**, **TS3**, **TS4**, **TS5**, or **TS6**.
3. *Optional.* To set the delay, complete the following steps:
 - a. Press the **Delay** soft key to set the amount of delay in μs .
 - b. Enter a value by using the numeric keys. You can also use the rotary knob.
 - c. Press the **μs** soft key.

NOTE

The Delay setting is used only when there is a time offset in the signals to be measured.

Measurement example

Figure 192 Channel power measurement with TD-SCDMA signal analyzer



NOTE

You can use the **LIMIT** hot key to analyze your measurements with the user-definable limit and Pass/Fail indication. See “Setting limit for RF tests” on page 401 for more information.

Occupied bandwidth

The Occupied Bandwidth measures the spectrum shape of the carrier. It is defined as the bandwidth, which includes 99% of the transmitted power among total transmitted power.

Setting measure setup

After configuring test parameters as described in the “Configuring test parameters” on page 387, you can continue your measurement.

Procedure

1. Press the **MEASURE SETUP** hot key.
2. Press the **Slot Number** soft key, and then select the time slot number to be displayed: **TS0**, **TS1**, **TS2**, **TS3**, **TS4**, **TS5**, or **TS6**.
3. *Optional.* To set the delay, complete the following steps:
 - a. Press the **Delay** soft key to set the amount of delay in μ s.
 - b. Enter a value by using the numeric keys. You can also use the rotary knob.
 - c. Press the **μ s** soft key.

NOTE

The Delay setting is used only when there is a time offset in the signals to be measured.

Measurement example

Figure 193 Occupied bandwidth measurement with TD-SCDMA signal analyzer



NOTE

You can use the **LIMIT** hot key to analyze your measurements with the user-definable limit and Pass/Fail indication. See “Setting limit for RF tests” on page 401 for more information.

Spectrum emission mask (SEM)

The Spectrum Emission Mask (SEM) measurement required by 3GPP specifications encompasses different power limits and different measurement bandwidths (resolution bandwidths) at various frequency offsets. It may be expressed as a ratio of power spectral densities between the carrier and the specified offset frequency band. It provides useful figures-of-merit for the spectral re-growth and emissions produced by components and circuit blocks, without the rigor of performing a full SEM measurement.

The SEM measures spurious signal levels in up to five pairs of offset or region frequencies and relates them to the carrier power.

Setting measure setup

After configuring test parameters as described in the “Configuring test parameters” on page 387, you can continue your measurement.

Procedure

1. Press the **MEASURE SETUP** hot key.
2. Press the **Slot Number** soft key, and then select the time slot number to be displayed: **TS0**, **TS1**, **TS2**, **TS3**, **TS4**, **TS5**, or **TS6**.
3. To select the mask type according to the output power of the base station, complete the following steps:
 - a. Press the **Mask Type** soft key.
 - b. Select the mask type option: **- 26 dBm**, **26 – 34 dBm**, or **34 dBm –**.

4. *Optional.* To set the delay, complete the following steps:
 - a. Press the **Delay** soft key to set the amount of delay in μ s.
 - b. Enter a value by using the numeric keys. You can also use the rotary knob.
 - c. Press the **μ s** soft key.

NOTE

The Delay setting is used only when there is a time offset in the signals to be measured.

Measurement example

Figure 194 SEM measurement with TD-SCDMA signal analyzer



NOTE

You can use the **LIMIT** hot key to analyze your measurements with the user-definable limit and Pass/Fail indication. See “Setting limit for RF tests” on page 401 for more information.

ACLR

The Adjacent Channel Leakage power Ratio (ACLR) measures the amount of interference or power in an adjacent frequency channel according to the standards.

Setting measure setup

After configuring test parameters as described in the “Configuring test parameters” on page 387, you can continue your measurement.

Procedure

1. Press the **MEASURE SETUP** hot key.
2. Press the **Slot Number** soft key, and then select the time slot number to be displayed: **TS0**, **TS1**, **TS2**, **TS3**, **TS4**, **TS5**, or **TS6**.
3. *Optional.* To set the delay, complete the following steps:
 - a. Press the **Delay** soft key to set the amount of delay in μ s.

- b. Enter a value by using the numeric keys. You can also use the rotary knob.
- c. Press the **µs** soft key.

NOTE

The Delay setting is used only when there is a time offset in the signals to be measured.

Measurement example

Figure 195 ACLR measurement with TD-SCDMA signal analyzer



NOTE

You can use the **LIMIT** hot key to analyze your measurements with the user-definable limit and Pass/Fail indication. See “Setting limit for RF tests” on page 401 for more information.

Multi-ACLR

The Multi-ACLR measurement is used to perform multi-channel ACLR measurements with as many channels as possible. It helps you to measure ACLR in multi-channel transmitting Base Station environment.

Setting measure setup

After configuring test parameters as described in the “Configuring test parameters” on page 387, you can continue your measurement.

Procedure

1. Press the **MEASURE SETUP** hot key.
2. To set the frequency, do one of the following:
 - To set the center frequency, complete the following steps:
 - a. Toggle the **Unit** soft key and select **Freq.**
 - b. Press the **Lowest Frequency** soft key to set the starting center frequency.
 - c. Enter a value by using the numeric keys. You can also use the rotary knob.

- d. Select the unit: **GHz, MHz, kHz, or Hz.**
 - e. Press the **Highest Frequency** soft key to set the stopping center frequency.
 - f. Enter a value by using the numeric keys. You can also use the rotary knob.
 - g. Select the unit: **GHz, MHz, kHz, or Hz.**
- To set the channel number, complete the following steps:
- a. Toggle the **Unit** soft key and select **Channel**.
 - b. To select the standard channel, press the **Channel Std** soft key and then select the band to be measured.
 - c. Press the **Lowest Channel** soft key to set the starting channel.
 - d. Enter a value by using the numeric keys. You can also use the rotary knob.
 - e. Press the **Enter** soft key.
 - f. Press the **Highest Channel** soft key to set the stopping channel.
 - g. Enter a value by using the numeric keys. You can also use the rotary knob.
 - h. Press the **Enter** soft key.

Measurement example

Figure 196 Multi-ACLR measurement with TD-SCDMA signal analyzer



NOTE

You can use the **LIMIT** hot key to analyze your measurements with the user-definable limit and Pass/Fail indication. See “Setting limit for RF tests” on page 401 for more information.

Spurious emissions

Out-of-band emissions are unwanted emissions immediately outside the channel bandwidth resulting from the modulation process and non-linearity in the transmitter but excluding spurious emissions. The Spurious Emissions measurement is to identify and determine the power level of out-of-band spurious emission within the necessary channel bandwidth and modulated signal measured at the RF port of the Base Station.

Setting measure setup

After configuring test parameters as described in the “Configuring test parameters” on page 387, you can continue your measurement.

Procedure

1. Press the **MEASURE SETUP** hot key.
2. To set up the range table and frequency range, press the **Range Table** soft key and then complete the following steps:
 - a. Press the **Range** soft key, and then enter the range number to add a new range or change an existing one.
 - b. Press the **Enter** soft key.
 - c. Press the **Start Frequency** soft key to set up the frequency range.
 - d. Enter a value by using the numeric keys. You can also use the rotary knob.
 - e. Select the unit: **GHz**, **MHz**, **kHz**, or **Hz**.
 - f. Press the **Stop Frequency** soft key to set up the frequency range.
 - g. Enter a value by using the numeric keys. You can also use the rotary knob.
 - h. Select the unit: **GHz**, **MHz**, **kHz**, or **Hz**.
3. Toggle the **Range** soft key between **On** and **Off** to display or hide the selected range.
4. To set up the test limits for Pass/Fail indication, complete the following steps:
 - a. Press the **Start Limit** soft key.
 - b. Enter a value by using the numeric keys. You can also use the rotary knob.
 - c. Select the **dBm** soft key.
 - d. Press the **Stop Limit** soft key.
 - e. Enter a value by using the numeric keys. You can also use the rotary knob.
 - f. Select the **dBm** soft key.
5. To set up the other parameters, complete the following steps:
 - a. Select **More (1/2) > Attenuation** to set up the attenuation value.
 - b. Enter a value in the multiple of five.
 - c. Press the **dB** soft key or the **ENTER** hard key.
 - d. Press the **RBW** soft key.
 - e. Enter a value by using the numeric keys.
 - f. Select the unit: **GHz**, **MHz**, **kHz**, or **Hz**.
 - g. Press the **VBW** soft key.
 - h. Enter a value by using the numeric keys.
 - i. Select the unit: **GHz**, **MHz**, **kHz**, or **Hz**.
6. Press the **PREV** hard key.
7. Toggle the **Measure Type** soft key between **Examine** and **Full** to select the measurement type.

NOTE

The **Examine** mode displays only the selected range while the **Full** mode lets the instrument automatically changes the selected range from one another.

8. Set the number of measurements to be averaged:
 - a. Press the **Average** soft key.
-

- b. Enter a value between 1 and 100.
- c. Press the **Enter** soft key.

Measurement example

Figure 197 Spurious emissions measurement with TD-SCDMA signal analyzer



NOTE

You can use the **LIMIT** hot key to analyze your measurements with the user-definable limit and Pass/Fail indication. See “Setting limit for RF tests” on page 401 for more information.

Setting limit for RF tests

By default, test limits specified in the standard are set for you. You can change thresholds if you desire.

Procedure

1. Press the **LIMIT** hot key.
2. Press the **RF Test Limits** soft key.
3. Select the test item(s) and set the limit(s) depending on your selected measurement mode:

To set the limit for	Select	Set
Channel power	Channel Power	High Limit Low Limit
Occupied bandwidth	Occupied BW	High Limit
Spectrum emission mask	Spectrum Emission Mask	(On/Off only)
ACLR	ACLR	(On/Off only)
Multi-ACLR	Multi-ACLR	(On/Off only)
Spurious emissions	Spurious Emissions	(On/Off only)

4. *Optional.* You can enable alarm sound that goes off if the measurement falls outside of the limit.

Toggle the **Beep** soft key between **On** and **Off** to enable or disable the beep sound.

5. *Optional.* Go to **SAVE/LOAD > Save**, and then select **Limit** to save the limit settings. See “Using save” on page 31 for more information.
-

Conducting power vs. time measurements

The Power vs. Time (P vs T) measurement analyzes the amplitude profile and timing of the burst signal and provides a time mask for the signal. It measures the mean transmit power during the “useful part” of TD-SCDMA bursts and verifies that the power ramp fits within the defined mask. TD-SCDMA is a Time Division Multiple Access (TDMA) scheme with seven time slots, or bursts, per RF channel and by using the “Multi-Slot” function, up to seven slots in a frame can be viewed at one time.

Power vs. time (slot)

The Power vs. Time (Slot) in TD-SCDMA Signal Analyzer measures the modulation envelope in the time domain, showing the signal rise and fall shape of TD-SCDMA signal.

Setting measure setup

After configuring test parameters as described in the “Configuring test parameters” on page 387, you can continue your measurement. The measurement settings can be saved and recalled as a file.

Procedure

1. Press the **MEASURE SETUP** hot key.
2. Press the **Slot Number** soft key, and then select the time slot number to be displayed: **TS0**, **TS1**, **TS2**, **TS3**, **TS4**, **TS5**, or **TS6**.
3. Press the **Spread Factor** soft key, and then select the spread factor option: **DL Auto** for auto detection of downlink, **UL Auto** for auto detection of uplink, **SF1**, **SF2**, **SF4**, **SF8**, or **SF16**.
4. To set the number of maximum users, complete the following steps:
 - a. Press the **Max Users** soft key.
 - b. Enter a value up to 16 by using the numeric keys.
 - c. Press the **Enter** soft key.
5. *Optional.* To set the delay, complete the following steps:
 - a. Press the **Delay** soft key to set the amount of delay in μ s.
 - b. Enter a value by using the numeric keys. You can also use the rotary knob.
 - c. Press the **μ s** soft key.

NOTE

The Delay setting is used only when there is a time offset in the signals to be measured.

6. *Optional.* Press the **Miscellaneous** soft key, and then do the following(s) as needed:
 - To select how to determine scrambling estimation, toggle the **Scramble** soft key and select **Spec** or **Full**.

NOTE

The Spec searches “Sync Sequence Number” from 0 to 31 based on the TD-SCDMA specification and determines “Scrambling Code Number” by using the sync sequence number, while the Full does from 0 to 127 fully.

- To select how to determine the Midamble spread factor estimation either in full or maximum
-

power search, toggle the **Mid SF Map** soft key and select **Max** or **Spec**.

NOTE

The Max determines the spread factor of the Midamble by using the maximum power of the received Midamble, while the Spec searches “Default Midamble Allocation” based on the TD-SCDMA specification.

- To select the detect mode, press the **Detect Mode** soft key and then select the option: **Auto**, **QPSK/8PSK**, **QPSK**, **8PSK**, **16 QAM**, or **64 QAM**.

Measurement example

Figure 198 Power vs. time (slot) measurement with TD-SCDMA signal analyzer



NOTE

You can use the **LIMIT** hot key to analyze your measurements with the user-definable limit and Pass/Fail indication. See “Setting limit for power vs. time tests” on page 408 for more information.

Power vs. time (frame)

The Power vs. Time (Frame) measures the modulation envelope in the time domain, showing the power of each time slot of the TD-SCDMA signal.

Setting measure setup

After configuring test parameters as described in the “Configuring test parameters” on page 387, you can continue your measurement. The measurement settings can be saved and recalled as a file.

Procedure

1. Press the **MEASURE SETUP** hot key.
2. Press the **Slot Number** soft key, and then select the time slot number to be displayed: **TS0**, **TS1**, **TS2**, **TS3**, **TS4**, **TS5**, or **TS6**.
3. Press the **Spread Factor** soft key, and then select the spread factor option: **DL Auto** for auto detection of downlink, **UL Auto** for auto detection of uplink, **SF1**, **SF2**, **SF4**, **SF8**, or **SF16**

4. To set the number of maximum users, complete the following steps:
 - a. Press the **Max Users** soft key.
 - b. Enter a value up to 16 by using the numeric keys.
 - c. Press the **Enter** soft key.
5. *Optional.* To set the delay, complete the following steps:
 - a. Press the **Delay** soft key to set the amount of delay in μ s.
 - b. Enter a value by using the numeric keys. You can also use the rotary knob.
 - c. Press the **μ s** soft key.

NOTE

The Delay setting is used only when there is a time offset in the signals to be measured.

6. *Optional.* Press the **Miscellaneous** soft key, and then do the following(s) as needed:
 - To select how to determine scrambling estimation, toggle the **Scramble** soft key and select **Spec** or **Full**.

NOTE

The Spec searches “Sync Sequence Number” from 0 to 31 based on the TD-SCDMA specification and determines “Scrambling Code Number” by using the sync sequence number, while the Full does from 0 to 127 fully.

- To select how to determine the Midamble spread factor estimation either in full or maximum power search, toggle the **Mid SF Map** soft key and select **Max** or **Spec**.

NOTE

The Max determines the spread factor of the Midamble by using the maximum power of the received Midamble, while the Spec searches “Default Midamble Allocation” based on the TD-SCDMA specification.

- To select the detect mode, press the **Detect Mode** soft key and then select the option: **Auto**, **QPSK/8PSK**, **QPSK**, **8PSK**, **16 QAM**, or **64 QAM**.

Measurement example

Figure 199 Power vs. time (frame) measurement with TD-SCDMA signal analyzer



NOTE

You can use the **LIMIT** hot key to analyze your measurements with the user-definable limit and Pass/Fail indication. See “Setting limit for power vs. time tests” on page 408 for more information. The On/Off Ratio is not used in the power vs. time (frame) tests.

Power vs. time (mask)

Setting measure setup

After configuring test parameters as described in the “Configuring test parameters” on page 387, you can continue your measurement. The measurement settings can be saved and recalled as a file.

Procedure

1. Press the **MEASURE SETUP** hot key.
2. Press the **Slot Number** soft key, and then select the time slot number to be displayed: **TS0**, **TS1**, **TS2**, **TS3**, **TS4**, **TS5**, or **TS6**.
3. Press the **Spread Factor** soft key, and then select the spread factor option: **DL Auto** for auto detection of downlink, **UL Auto** for auto detection of uplink, **SF1**, **SF2**, **SF4**, **SF8**, or **SF16**.
4. To set the number of maximum users, complete the following steps:
 - a. Press the **Max Users** soft key.
 - b. Enter a value up to 16 by using the numeric keys.
 - c. Press the **Enter** soft key.
5. *Optional.* To set the delay, complete the following steps:
 - a. Press the **Delay** soft key to set the amount of delay in μ s.
 - b. Enter a value by using the numeric keys. You can also use the rotary knob.
 - c. Press the **μ s** soft key.

NOTE

The Delay setting is used only when there is a time offset in the signals to be measured.

6. *Optional.* Press the **Miscellaneous** soft key, and then do the following(s) as needed:
 - To select how to determine scrambling estimation, toggle the **Scramble** soft key and select **Spec** or **Full**.

NOTE

The Spec searches “Sync Sequence Number” from 0 to 31 based on the TD-SCDMA specification and determines “Scrambling Code Number” by using the sync sequence number, while the Full does from 0 to 127 fully.

- To select how to determine the Midamble spread factor estimation either in full or maximum power search, toggle the **Mid SF Map** soft key and select **Max** or **Spec**.

NOTE

The Max determines the spread factor of the Midamble by using the maximum power of the received Midamble, while the Spec searches “Default Midamble Allocation” based on the TD-SCDMA specification.

- To select the detect mode, press the **Detect Mode** soft key and then select the option: **Auto**, **QPSK/8PSK**, **QPSK**, **8PSK**, **16 QAM**, or **64 QAM**.
-

Measurement example

Figure 200 Power vs. time (mask) measurement with TD-SCDMA signal analyzer



NOTE

You can use the **LIMIT** hot key to analyze your measurements with the user-definable limit and Pass/Fail indication. See “Setting limit for power vs. time tests” on page 408 for more information. The DwPTS Power and UpPTS Power are not used in the power vs. time (mask) tests.

Timogram

Setting measure setup

After configuring test parameters as described in the “Configuring test parameters” on page 387, you can continue your measurement. The measurement settings can be saved and recalled as a file.

Procedure

1. Press the **MEASURE SETUP** hot key.
2. Press the **Spread Factor** soft key, and then select the spread factor option: **DL Auto** for auto detection of downlink, **UL Auto** for auto detection of uplink, **SF1**, **SF2**, **SF4**, **SF8**, or **SF16**
3. To set the number of maximum users, complete the following steps:
 - a. Press the **Max Users** soft key.
 - b. Enter a value up to 16 by using the numeric keys.
 - c. Press the **Enter** soft key.
4. To set the time interval, complete the following steps:
 - a. Press the **Time Interval** soft key.
 - b. Enter a value by using the numeric keys.
 - c. Press the **Enter** soft key.
5. To place the time cursor to analyze your measurements, complete the following steps:
 - a. Toggle the **Time Cursor** soft key between **On** and **Off** to enable or disable the time cursor.
 - b. Enter a value by using the numeric keys.

- c. Press the **Enter** soft key.

NOTE
When the time cursor is enabled, the measurement is put on hold and information about the time cursor is displayed.

- 6. *Optional.* Press the **Miscellaneous** soft key, and then do the following(s) as needed:

- To set the delay, complete the following steps:
 - a. Press the **Delay** soft key to set the amount of delay in μs .
 - b. Enter a value by using the numeric keys. You can also use the rotary knob.
 - c. Press the **μs** soft key.

NOTE
The Delay setting is used only when there is a time offset in the signals to be measured.

- To select how to determine scrambling estimation, toggle the **Scramble** soft key and select **Spec** or **Full**.

NOTE
The Spec searches "Sync Sequence Number" from 0 to 31 based on the TD-SCDMA specification and determines "Scrambling Code Number" by using the sync sequence number, while the Full does from 0 to 127 fully.

- To select how to determine the Midamble spread factor estimation either in full or maximum power search, toggle the **Mid SF Map** soft key and select **Max** or **Spec**.

NOTE
The Max determines the spread factor of the Midamble by using the maximum power of the received Midamble, while the Spec searches "Default Midamble Allocation" based on the TD-SCDMA specification.

- To select the detect mode, press the **Detect Mode** soft key and then select the option: **Auto**, **QPSK/8PSK**, **QPSK**, **8PSK**, **16 QAM**, or **64 QAM**.

Measurement example

Figure 201 Timogram with TD-SCDMA signal analyzer



Setting limit for power vs. time tests

Procedure

1. Press the **LIMIT** hot key.
2. Press the **PvsT Test Limits** soft key.
3. Select the test item(s) and set the limit(s) depending on your selected measurement mode:

To set the limit for	Select	Set
Slot power	Slot Power	High Limit, Low Limit
Downlink pilot signal power	DwPTS Power	High Limit, Low Limit
Uplink pilot signal power	UpPTS Power	High Limit, Low Limit
Power between on and off portions of the downlink slots	On/Off Ratio	High Limit, Low Limit

4. *Optional.* You can enable alarm sound that goes off if the measurement falls outside of the limit. Toggle the **Beep** soft key between **On** and **Off** to enable or disable the beep sound.
 5. *Optional.* Go to **SAVE/LOAD > Save**, and then select **Limit** to save the limit settings. See “Using save” on page 31 for more information.
-

Conducting modulation measurements

TD-SCDMA receivers rely on the frequency or phase quality of the QPSK or 8PSK signal in order to achieve the expected carrier to noise performance. A transmitter with high frequency or phase error is often still able to support phone calls during a functional test. It displays the frequency errors numerically and graphically, showing the binary representation of the demodulated data bits of the received signal using Constellation, Midamble Power, Code Power, and Code Error screens.

Constellation

The Constellation is used to observe some aspects of modulation accuracy and can reveal certain fault mechanisms such as I/Q amplitude imbalance or quadrature imbalance. It displays constellation diagram by modulation types.

Setting measure setup

After configuring test parameters as described in the “Configuring test parameters” on page 387, you can continue your measurement. The measurement settings can be saved and recalled as a file. You can also use JDViewer, PC application software to configure a measure setup, save as a file, and load the file on to the instrument.

Procedure

1. Press the **MEASURE SETUP** hot key.
 2. Toggle the **Scramble** soft key and select **Auto** or **Manual** to set the scramble code automatically or manually.
 3. Press the **Slot Number** soft key, and then select the time slot number to be displayed: **TS0**, **TS1**, **TS2**, **TS3**, **TS4**, **TS5**, or **TS6**.
 4. Press the **Spread Factor** soft key, and then select the spread factor option: **DL Auto** for auto detection of downlink, **UL Auto** for auto detection of uplink, **SF1**, **SF2**, **SF4**, **SF8**, or **SF16**
-

5. To set the number of maximum users, complete the following steps:
 - a. Press the **Max Users** soft key.
 - b. Enter a value up to 16 by using the numeric keys, and then press the **Enter** soft key.
6. *Optional.* Press the **Miscellaneous** soft key, and then do the following(s) as needed:
 - To set the delay, complete the following steps:
 - a. Press the **Delay** soft key to set the amount of delay in μ s.
 - b. Enter a value by using the numeric keys. You can also use the rotary knob.
 - c. Press the **μ s** soft key.

NOTE
The Delay setting is used only when there is a time offset in the signals to be measured.

- To select how to determine scrambling estimation, toggle the **Scramble** soft key and select **Spec** or **Full**.

NOTE
The Spec searches “Sync Sequence Number” from 0 to 31 based on the TD-SCDMA specification and determines “Scrambling Code Number” by using the sync sequence number, while the Full does from 0 to 127 fully.

- To select how to determine the Midamble spread factor estimation either in full or maximum power search, toggle the **Mid SF Map** soft key and select **Max** or **Spec**.

NOTE
The Max determines the spread factor of the Midamble by using the maximum power of the received Midamble, while the Spec searches “Default Midamble Allocation” based on the TD-SCDMA specification.

- To select the detect mode, press the **Detect Mode** soft key and then select the option: **Auto**, **QPSK/8PSK**, **QPSK**, **8PSK**, **16 QAM**, or **64 QAM**.
- To set the relative threshold, complete the following steps:
 - a. Press the **Threshold** soft key. Its default setting is -27 dB.
 - b. Enter a value between -50 and zero by using the numeric keys.
 - c. Press the **Enter** soft key.

Measurement example

Figure 202 Constellation measurement with TD-SCDMA signal analyzer



NOTE

You can use the **LIMIT** hot key to analyze your measurements with the user-definable limit and Pass/Fail indication. See “Setting limit for modulation tests” on page 414 for more information. The Max Inactive is not used in the Constellation mode.

Midamble power

Setting measure setup

After configuring test parameters as described in the “Configuring test parameters” on page 387, you can continue your measurement. The measurement settings can be saved and recalled as a file. You can also use JDViewer, PC application software to configure a measure setup, save as a file, and load the file on to the instrument.

Procedure

1. Press the **MEASURE SETUP** hot key.
2. Toggle the **Scramble** soft key and select **Auto** or **Manual** to set the scramble code automatically or manually.
3. Press the **Slot Number** soft key, and then select the time slot number to be displayed: **TS0**, **TS1**, **TS2**, **TS3**, **TS4**, **TS5**, or **TS6**.
4. Press the **Spread Factor** soft key, and then select the spread factor option: **DL Auto** for auto detection of downlink, **UL Auto** for auto detection of uplink, **SF1**, **SF2**, **SF4**, **SF8**, or **SF16**
5. To set the number of maximum users, complete the following steps:
 - a. Press the **Max Users** soft key.
 - b. Enter a value up to 16 by using the numeric keys.
 - c. Press the **Enter** soft key.
6. *Optional.* Press the **Miscellaneous** soft key, and then do the following(s) as needed:
 - To set the delay, complete the following steps:
 - a. Press the **Delay** soft key to set the amount of delay in μ s.
 - b. Enter a value by using the numeric keys. You can also use the rotary knob.
 - c. Press the **μ s** soft key.

NOTE

The Delay setting is used only when there is a time offset in the signals to be measured.

- To select how to determine scrambling estimation, toggle the **Scramble** soft key and select **Spec** or **Full**.

NOTE

The Spec searches “Sync Sequence Number” from 0 to 31 based on the TD-SCDMA specification and determines “Scrambling Code Number” by using the sync sequence number, while the Full does from 0 to 127 fully.

- To select how to determine the Midamble spread factor estimation either in full or maximum power search, toggle the **Mid SF Map** soft key and select **Max** or **Spec**.

NOTE

The Max determines the spread factor of the Midamble by using the maximum power of the received Midamble, while the Spec searches “Default Midamble Allocation” based on the TD-SCDMA specification.

- To select the detect mode, press the **Detect Mode** soft key and then select the option: **Auto**, **QPSK/8PSK**, **QPSK**, **8PSK**, **16 QAM**, or **64 QAM**.
 - To set the relative threshold, complete the following steps:
-

- a. Press the **Threshold** soft key. Its default setting is -27 dB.
- b. Enter a value between -50 and zero by using the numeric keys.
- c. Press the **Enter** soft key.

Measurement example

Figure 203 Midamble measurement with TD-SCDMA signal analyzer



Code power

Setting measure setup

After configuring test parameters as described in the “Configuring test parameters” on page 387, you can continue your measurement. The measurement settings can be saved and recalled as a file. You can also use JDViewer, PC application software to configure a measure setup, save as a file, and load the file on to the instrument.

Procedure

1. Press the **MEASURE SETUP** hot key.
2. Toggle the **Scramble** soft key and select **Auto** or **Manual** to set the scramble code automatically or manually.
3. Press the **Slot Number** soft key, and then select the time slot number to be displayed: **TS0**, **TS1**, **TS2**, **TS3**, **TS4**, **TS5**, or **TS6**.
4. Press the **Spread Factor** soft key, and then select the spread factor option: **DL Auto** for auto detection of downlink, **UL Auto** for auto detection of uplink, **SF1**, **SF2**, **SF4**, **SF8**, or **SF16**
5. To set the number of maximum users, complete the following steps:
 - a. Press the **Max Users** soft key.
 - b. Enter a value up to 16 by using the numeric keys.
 - c. Press the **Enter** soft key.
6. *Optional.* Press the **Miscellaneous** soft key, and then do the following(s) as needed:
 - To set the delay, complete the following steps:

- a. Press the **Delay** soft key to set the amount of delay in μs .
- b. Enter a value by using the numeric keys. You can also use the rotary knob.
- c. Press the **μs** soft key.

NOTE

The Delay setting is used only when there is a time offset in the signals to be measured.

- To select how to determine scrambling estimation, toggle the **Scramble** soft key and select **Spec** or **Full**.

NOTE

The Spec searches “Sync Sequence Number” from 0 to 31 based on the TD-SCDMA specification and determines “Scrambling Code Number” by using the sync sequence number, while the Full does from 0 to 127 fully.

- To select how to determine the Midamble spread factor estimation either in full or maximum power search, toggle the **Mid SF Map** soft key and select **Max** or **Spec**.

NOTE

The Max determines the spread factor of the Midamble by using the maximum power of the received Midamble, while the Spec searches “Default Midamble Allocation” based on the TD-SCDMA specification.

- To select the detect mode, press the **Detect Mode** soft key and then select the option: **Auto**, **QPSK/8PSK**, **QPSK**, **8PSK**, **16 QAM**, or **64 QAM**.
- To set the relative threshold, complete the following steps:
 - a. Press the **Threshold** soft key. Its default setting is -27 dB.
 - b. Enter a value between -50 and zero by using the numeric keys.
 - c. Press the **Enter** soft key.

Measurement example

Figure 204 Code power measurement with TD-SCDMA signal analyzer



NOTE

You can use the **LIMIT** hot key to analyze your measurements with the user-definable limit and Pass/Fail indication for the Max Inactive. See “Setting limit for modulation tests” on page 414 for more information.

Code error

Setting measure setup

After configuring test parameters as described in the “Configuring test parameters” on page 387, you can continue your measurement. The measurement settings can be saved and recalled as a file. You can also use JDViewer, PC application software to configure a measure setup, save as a file, and load the file on to the instrument.

Procedure

1. Press the **MEASURE SETUP** hot key.
2. Toggle the **Scramble** soft key and select **Auto** or **Manual** to set the scramble code automatically or manually.
3. Press the **Slot Number** soft key, and then select the time slot number to be displayed: **TS0**, **TS1**, **TS2**, **TS3**, **TS4**, **TS5**, or **TS6**.
4. Press the **Spread Factor** soft key, and then select the spread factor option: **DL Auto** for auto detection of downlink, **UL Auto** for auto detection of uplink, **SF1**, **SF2**, **SF4**, **SF8**, or **SF16**.
5. To set the number of maximum users, complete the following steps:
 - a. Press the **Max Users** soft key.
 - b. Enter a value up to 16 by using the numeric keys.
 - c. Press the **Enter** soft key.
6. *Optional.* Press the **Miscellaneous** soft key, and then do the following(s) as needed:
 - To set the delay, complete the following steps:
 - a. Press the **Delay** soft key to set the amount of delay in μ s.
 - b. Enter a value by using the numeric keys. You can also use the rotary knob.
 - c. Press the **μ s** soft key.

NOTE

The Delay setting is used only when there is a time offset in the signals to be measured.

- To select how to determine scrambling estimation, toggle the **Scramble** soft key and select **Spec** or **Full**.

NOTE

The Spec searches “Sync Sequence Number” from 0 to 31 based on the TD-SCDMA specification and determines “Scrambling Code Number” by using the sync sequence number, while the Full does from 0 to 127 fully.

- To select how to determine the Midamble spread factor estimation either in full or maximum power search, toggle the **Mid SF Map** soft key and select **Max** or **Spec**.

NOTE

The Max determines the spread factor of the Midamble by using the maximum power of the received Midamble, while the Spec searches “Default Midamble Allocation” based on the TD-SCDMA specification.

- To select the detect mode, press the **Detect Mode** soft key and then select the option: **Auto**, **QPSK/8PSK**, **QPSK**, **8PSK**, **16 QAM**, or **64 QAM**.
 - To set the relative threshold, complete the following steps:
 - a. Press the **Threshold** soft key. Its default setting is -27 dB.
 - b. Enter a value between -50 and zero by using the numeric keys.
 - c. Press the **Enter** soft key.
-

Measurement example

Figure 205 Code error measurement with TD-SCDMA signal analyzer



NOTE

You can use the **LIMIT** hot key to analyze your measurements with the user-definable limit and Pass/Fail indication for the Max Inactive. See “Setting limit for modulation tests” on page 414 for more information.

Setting limit for modulation tests

Procedure

1. Press the **LIMIT** hot key.
2. Press the **Modulation Test Limits** soft key.
3. Select the test item(s) and set the limit(s) depending on your selected measurement mode:

To set the limit for	Select	Set
Frequency error	Frequency Error	High Limit Low Limit
Error vector magnitude rms	EVM RMS	High Limit
Peak code domain error	PCDE	High Limit
Highest level among inactive channels	Max Inactive	High Limit

4. *Optional.* You can enable alarm sound that goes off if the measurement falls outside of the limit. Toggle the **Beep** soft key between **On** and **Off** to enable or disable the beep sound.
5. *Optional.* Go to **SAVE/LOAD > Save**, and then select **Limit** to save the limit settings. See “Using save” on page 31 for more information.

Performing auto measurements

The Auto Measure function of the JD780A series allows a complete signal profiling covering RF characterization and modulation quality parameters of up to 10 different carriers, particularly useful on

an overlay architecture where base stations are transmitting in different frequencies.

The Auto Measure can be easily executed either by selecting a menu in the instrument or by running a programmed scenario in the PC-based application so that the instrument automatically configure and perform tests on every aspect of all the carriers.

Setting limit

You can set test limits for test item(s) in the auto measurement.

Procedure

1. Press the **LIMIT** hot key.
 2. Press the **RF Test Limits** soft key, and then enable test limits as desired.
 3. Press the **PvsT Test Limits** soft key, and then enable test limits as desired.
 4. Press the **Modulation Test Limits** soft key, and then enable test limits as desired.
 5. *Optional.* You can enable alarm sound that goes off if the measurement falls outside of the limit. Toggle the **Beep** soft key between **On** and **Off** to enable or disable the beep sound.
 6. *Optional.* Go to **SAVE/LOAD > Save**, and then select **Limit** to save the limit settings. See "Using save" on page 31 for more information.
-

Setting measure setup

After configuring test parameters as described in the "Configuring test parameters" on page 387, you can continue your measurement. The measurement settings can be saved and recalled as a file. You can also use JDViewer, PC application software to configure a measure setup, save as a file, and load the file on to the instrument.

Procedure

1. Press the **MEASURE SETUP** hot key.
 2. Toggle the **Configuration** soft key and select the configuration option:
 - **Current**: to let the instrument use current frequency (single carrier) and determine pass or fail based on the instrument's limit settings in Auto Measure.
 - **Scenario**: to run a test with a programmed scenario in JDViewer. The Scenario menu becomes activated.
 3. To load a scenario, press the **Scenario** soft key, and then select a scenario file to load.
 4. Toggle the **Test Time** soft key and select the test time option:
 - **Now**: to let the instrument run a test only once.
 - **Schedule**: to let the instrument repeat tests as defined in the Set Timing. The Set Timing menu becomes activated.
 5. To define a schedule for an auto measurement, complete the following steps:
 - a. Press the **Set Timing** soft key.
 - b. Press the **Start Time (HH:MM)** soft key.
 - c. Enter the time in the HH:MM format, and then press the **Enter** soft key.
 - d. Press the **Stop Time (HH:MM)** soft key.
 - e. Enter the time in the HH:MM format, and then press the **Enter** soft key.
 - f. Press the **Time Interval** soft key.
-

-
- g. Enter the amount of time in minutes, and then press the **Enter** soft key.
7. Press the **Settings** soft key, and then set the following:
 - a. Press the **Slot Number** soft key, and then select the time slot number to be displayed: **TS0**, **TS1**, **TS2**, **TS3**, **TS4**, **TS5**, or **TS6**.
 - b. Toggle the **External Offset** soft key and select **On**.
 - c. Enter a value by using the numeric keys, and then press the **dB** soft key.
 8. To save your settings and results, go to **SAVE/LOAD > Save** and then perform functions as you desire. See "Using save" on page 31 for more information.
 9. Press the **Run Test** soft key to start to run a test.
The Auto Measure Results window appears at the end of the test.
 10. To stop running the test, press the **Abort** soft key.
 11. To change the view on the screen during the test, press the **Display** and then select the view option from the following choices:
 - **Screen**: You can view each measurement screen as the test progresses.
 - **Results**: You can view a measurement result table as the test progresses.
 - **Settings**: You can view a measurement setting table as the test progresses.
-

Setting display

After completion of the auto measurement, the screen menu changes to Trace/Display so that you can view the results in different forms.

Procedure

1. Toggle the **Display** soft key and select the display option:
 - **Result**: to view the result table.
The Display Result menu becomes activated.
 - **Settings**: to view the measurement settings for the auto measurement.
 2. Toggle the **Display Result** soft key and select the display result option:
 - **Full**: to view detailed measurement readings with the pass/fail indication.
 - **Quick**: to view only the Pass/Fail results.
 3. To view the measurement results for a different carrier, press the **View Carrier** soft key and then select the carrier number to view.
-

Conducting TD-SCDMA OTA measurements

Sync-DL ID scanner

Setting measure setup

After configuring test parameters as described in the "Configuring test parameters" on page 387, you can continue your measurement.

Procedure

1. Press the **MEASURE SETUP** hot key.
 2. Toggle the **Sync-DL ID** soft key and select **Auto** or **Manual** to set the Sync Downlink ID
-

automatically or manually.

3. *Optional.* To select the delay, complete the following steps:
 - a. Press the **Miscellaneous** soft key.
 - b. Press the **Delay** soft key to set the amount of delay in μs .
 - c. Enter a value by using the numeric keys. You can also use the rotary knob.
 - d. Press the **μs** soft key.

NOTE

The Delay setting is used only when there is a time offset in the signals to be measured.

4. *Optional.* Go to **SAVE/LOAD > Save**, and then select the save option from the choices available for your measurement mode. See “Using save” on page 31 for more information.

Measurement example

Figure 206 Sync-DL ID scanner measurement with TD-SCDMA OTA signal analyzer



Sync-DL ID vs. Tau

Setting measure setup

After configuring test parameters as described in the “Configuring test parameters” on page 387, you can continue your measurement.

Procedure

1. Press the **MEASURE SETUP** hot key.
2. Toggle the **Sync-DL ID** soft key and select **Auto** or **Manual** to set the Sync Downlink ID automatically or manually.
3. *Optional.* To select the delay, complete the following steps:
 - a. Press the **Miscellaneous** soft key.
 - b. Press the **Delay** soft key to set the amount of delay in μs .
 - c. Enter a value by using the numeric keys. You can also use the rotary knob.

- d. Press the **µs** soft key.

NOTE

The Delay setting is used only when there is a time offset in the signals to be measured.

4. *Optional.* Go to **SAVE/LOAD > Save**, and then select the save option from the choices available for your measurement mode. See “Using save” on page 31 for more information.

Measurement example

Figure 207 Sync-DL ID vs. Tau measurement with TD-SCDMA OTA signal analyzer



Sync-DL ID multipath

Setting measure setup

After configuring test parameters as described in the “Configuring test parameters” on page 387, you can continue your measurement.

Procedure

1. Press the **MEASURE SETUP** hot key.
2. Toggle the **Sync-DL ID** soft key and select **Auto** or **Manual** to set the Sync Downlink ID automatically or manually.
3. *Optional.* To select the delay, complete the following steps:
 - a. Press the **Miscellaneous** soft key.
 - b. Press the **Delay** soft key to set the amount of delay in µs.
 - c. Enter a value by using the numeric keys. You can also use the rotary knob.
 - d. Press the **µs** soft key.

NOTE

The Delay setting is used only when there is a time offset in the signals to be measured.

4. *Optional.* Go to **SAVE/LOAD > Save**, and then select the save option from the choices available for your measurement mode. See “Using save” on page 31 for more information.

Measurement example

Figure 208 Sync-DL ID multipath measurement with TD-SCDMA OTA signal analyzer



Sync-DL ID analyzer

Setting measure setup

After configuring test parameters as described in the “Configuring test parameters” on page 387, you can continue your measurement.

Procedure

1. Press the **MEASURE SETUP** hot key.
2. Toggle the **Sync-DL ID** soft key and select **Auto** or **Manual** to set the Sync Downlink ID automatically or manually.
3. *Optional.* To select the delay, complete the following steps:
 - a. Press the **Miscellaneous** soft key.
 - b. Press the **Delay** soft key to set the amount of delay in µs.
 - c. Enter a value by using the numeric keys. You can also use the rotary knob.
 - d. Press the **µs** soft key.

NOTE

The Delay setting is used only when there is a time offset in the signals to be measured.

4. *Optional.* Go to **SAVE/LOAD > Save**, and then select the save option from the choices available for your measurement mode. See “Using save” on page 31 for more information.

Setting limit for Sync-DL ID analyzer

Procedure

1. Press the **LIMIT** hot key.
2. To set the limit for rms of the error vector magnitude, complete the following steps:

- a. Press the **EVM RMS** soft key.
 - b. Toggle the **Test Limits** soft key between **On** and **Off** to enable or disable the limit.
 - c. Press the **High Limit** soft key, and then enter a value for the upper threshold.
 - d. Press the **Enter** soft key.
3. To set the limit for frequency error, complete the following steps:
 - a. Press the **Frequency Error** soft key.
 - b. Toggle the **Test Limits** soft key between **On** and **Off** to enable or disable the limit.
 - c. Press the **High Limit** soft key, and then enter a value for the upper threshold.
 - d. Press the **ppm** soft key.
 - e. Press the **Low Limit** soft key, and then enter a value for the lower threshold.
 - f. Press the **ppm** soft key.
 4. *Optional.* You can enable alarm sound that goes off if the measurement falls outside of the limit. Toggle the **Beep** soft key between **On** and **Off** to enable or disable the beep sound.
 5. *Optional.* Go to **SAVE/LOAD > Save**, and then select **Limit** to save the limit settings. See “Using save” on page 31 for more information.

Measurement example

Figure 209 Sync-DL ID analyzer measurement with TD-SCDMA OTA signal analyzer



Route map

The JD780A Series provides indoor and outdoor mapping function that allows a user to collect data of points in an indoor or outdoor environment and track the received signals and coverage of RF transmitters plotting real time directly on top of a loaded floor plan or a map.

Setting measure setup

Procedure

1. If required, connect a GPS receiver to your JD780A series for outdoor mapping.

Indoor mapping does not necessarily need a GPS antenna.

2. Configure test parameters as described in the “Configuring test parameters” on page 387.
3. To load your map file, complete the following steps:
 - a. Plug in your USB drive that has a floor map or .mcf file type created in JDMapCreator.

NOTE

The JDMapCreator converts and resizes any scanned floor plan or layout to fit onto your instrument’s display. You must save your map files (.mcf) into the “**SavedMap**” folder of your USB drive so that you can load them onto your instrument.

- b. Press **SAVE/LOAD** hot key, and then select **Load > Load Map**. See “Using load” on page 34 for more information.
4. Press the **MEASURE SETUP** hot key.
5. Press the **Plot Point** soft key, and then select the plot point option from the following choices:
 - To collect data/plot points automatically as you move around in a vehicle or outside, press the **GPS** soft key and then toggle the **Screen Mode** soft key between **Map** and **Full**.

NOTE

With the **Map** setting, you can view only the collected points that can be seen within the boundary of the loaded map. If a point is off the map, the instrument displays an arrow to indicate the direction of the current location on the map and the distance from the center to the location at the top of the screen.

With the **Full** setting, you can view all the collected points of the route without the loaded map.

- To collect data/plot points manually without a GPS antenna in an indoor environment, press the **Position** soft key.
6. Toggle the **Plot** soft key and select **Start** to start plotting.
 7. Touch directly on the screen or press the **ENTER** hard key to collect data and plot points on the loaded map for the **Position** setting.

NOTE

For the **Position** setting, you can change the direction of the route with the arrow keys and the distance with the rotary knob.

8. Toggle the **Plot** soft key and select **Stop** to stop plotting.
9. Press the **SAVE/LOAD** hot key to save the result. See “Using save” on page 31 for more information.

NOTE

The instrument does not automatically save the collected data. It is recommended that you save the result. Otherwise, you will lose all the collected data.

Setting limit for route map

You can set the thresholds for each test item.

Procedure

1. Press the **LIMIT** hot key.
 2. Press the **Excellent** soft key to set its threshold.
 3. Enter a value, and then press the **Enter** soft key. You can also use the rotary knob.
 4. Press the **Very Good** soft key to set its threshold.
-

5. Enter a value, and then press the **Enter** soft key. You can also use the rotary knob.
6. Press the **Good** soft key to set its threshold.
7. Enter a value, and then press the **Enter** soft key. You can also use the rotary knob.
8. Press the **Fair** soft key to set its threshold.
9. Enter a value, and then press the **Enter** soft key. You can also use the rotary knob.
10. Press the **Poor** soft key to set its threshold.
11. Enter a value, and then press the **Enter** soft key. You can also use the rotary knob.
12. *Optional.* Go to **SAVE/LOAD > Save**, and then select **Limit** to save the limit settings. See "Using save" on page 31 for more information.

Measurement example

Figure 210 Route map measurement with TD-SCDMA OTA signal analyzer

1) Map view

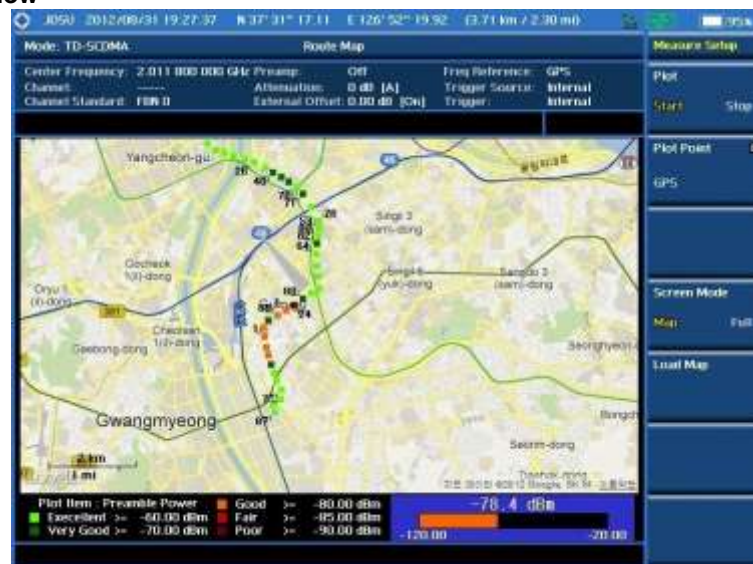

2) Full view



Using Mobile WiMAX Signal Analyzer

This chapter provides instructions for using the Mobile WiMAX Signal Analyzer function (option 026) with the Mobile WiMAX OTA Analyzer function (option 046). Topics discussed in this chapter are as follows:

■ Introduction	424
■ Display overview	424
■ Connecting a cable	425
■ Selecting measurement mode	427
■ Configuring test parameters	427
■ Conducting spectrum measurements	432
■ Conducting RF measurements	434
■ Conducting power vs. time (frame) measurements	441
■ Conducting modulation measurements	443
■ Performing auto measurements	451
■ Performing power statistics CCDF measurements	452
■ Conducting Mobile WiMAX OTA measurements	453

Introduction

The Mobile WiMAX Signal Analyzer performs power and spectrum measurements as well as modulation analysis to test the proper transmitter performance of Mobile WiMAX systems. It performs conformance testing according to the following standards providing a simple Pass/Fail indication on each test.

- IEEE 802.16e-2005
- WiBro (Korean Mobile WiMAX OFDMA Service)

This instrument provides the following measurement tools for Mobile WiMAX system:

- Spectrum Analysis
- RF Analysis
 - Channel Power
 - Occupied Bandwidth
 - Spectrum Emission Mask
 - Spurious Emissions
- Power vs. Time (Frame)
- Modulation Analysis
 - Constellation
 - Spectral Flatness
 - EVM vs. Subcarrier
 - EVM vs. Symbol
- Auto Measure
- Power Statistics CCDF
- Over The Air (OTA)
 - Preamble Scanner
 - Multipath Profile
 - Preamble Power Trend
 - Route Map

Display overview

Figure 211 provides descriptions for each segment of the measurement screen.

Figure 211 Mobile WiMAX signal analyzer measurement screen

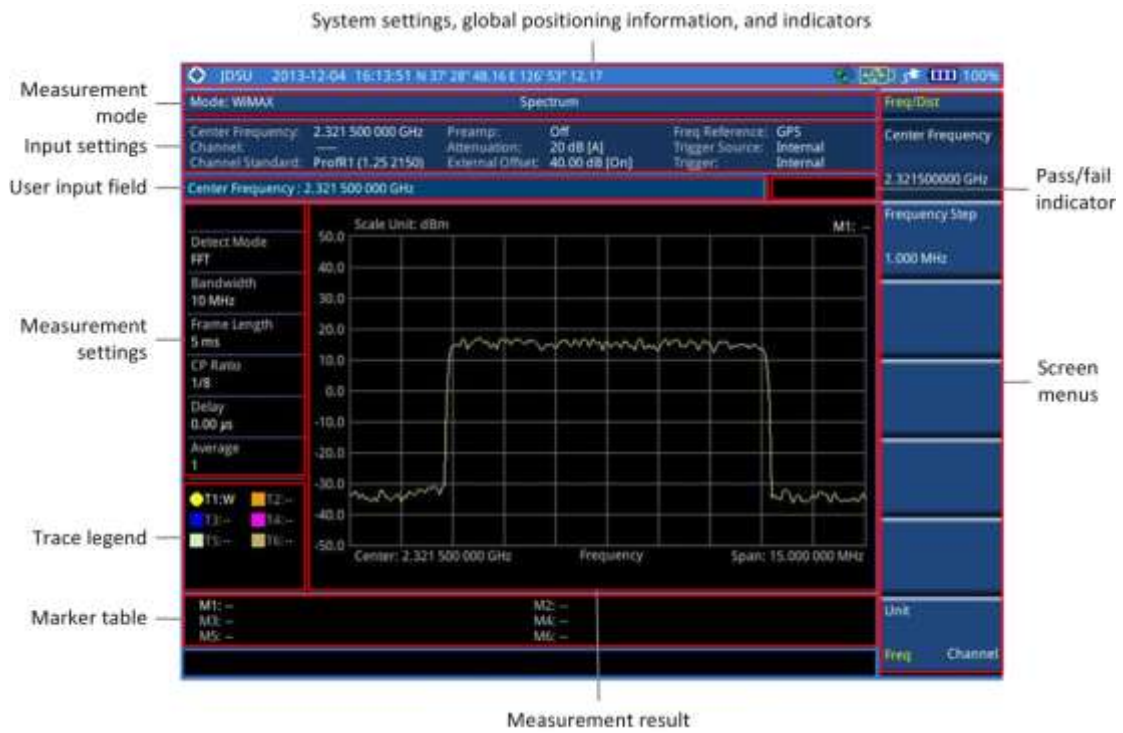

Connecting a cable

Direct connection

Procedure

1. Connect the **Spectrum Analyzer RF In** port of the JD780A series and the Power amplifier output port of BTS.

Figure 212 Direct connection





Indirect connection

Procedure

1. Connect the **Spectrum Analyzer RF In** port of the JD780A series and the monitor (test) port of BTS.

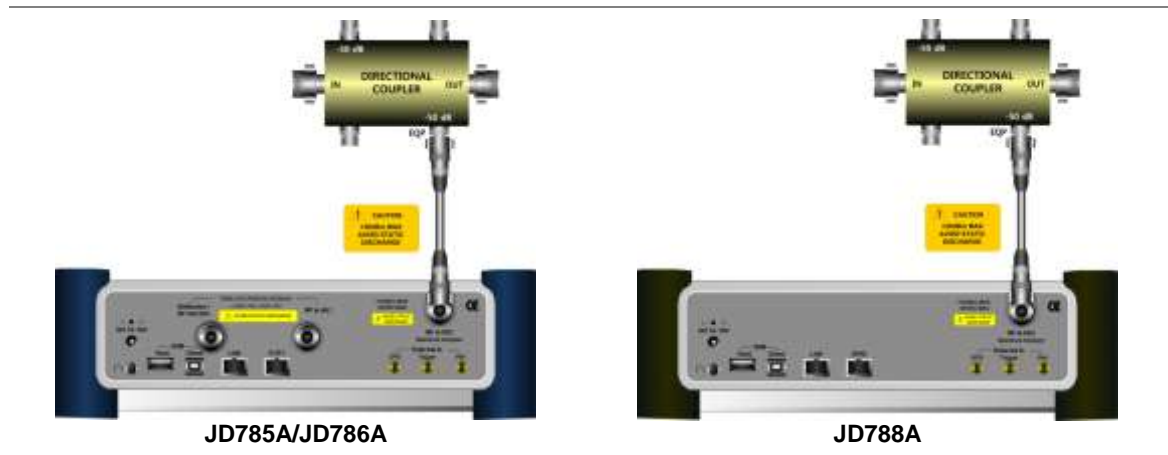
Figure 213 Indirect connection



CAUTION
 The maximum power for the **Spectrum Analyzer RF In** port is +25 dBm (0.316 W). If the input signal level to be measured is greater than +25 dBm, use a **High Power Attenuator** to prevent damage when you directly connect the signal to the instrument or connect the signal from the coupling port of a directional coupler.

Over the air (OTA)

Procedure

1. Connect an Omni/directional RF antenna to the **Spectrum Analyzer RF In** port of the JD780A series.
2. Connect a GPS antenna to the **GPS** port of the JD780A series.

Figure 214 OTA connection

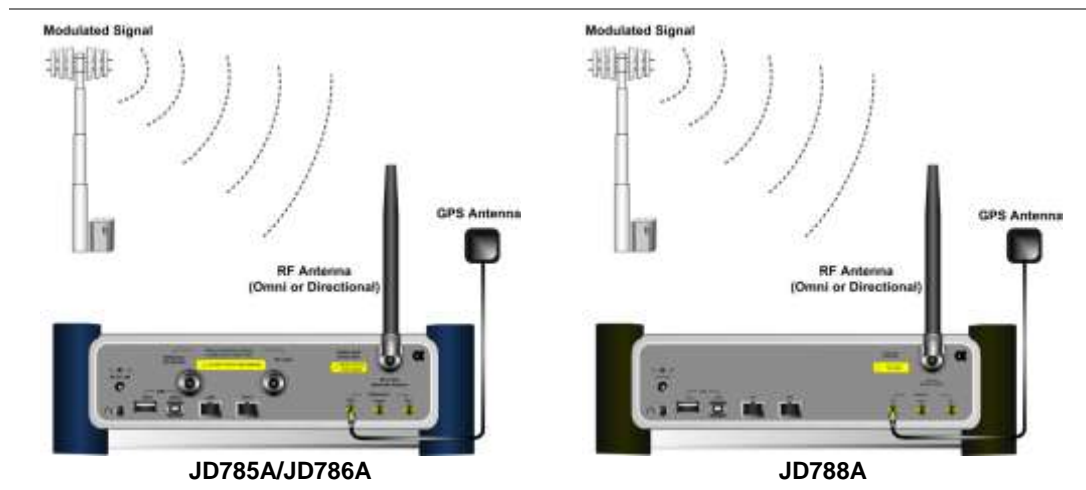

CAUTION
 If the input signal level to be measured is less than 0 dBm, set 0 dB attenuation or turn on the preamp to have better dynamic range for the OTA testing.

Selecting measurement mode

Procedure

1. Press the **MODE** hard key.
 2. Press the **Signal Analyzer** soft key.
 3. Press the **More (1/2) > Mobile WiMAX** soft key. The **Spectrum** mode is set by default.
 4. Press the **MEASURE** hot key, and then select the measurement mode option from the following choices:
 - Spectrum
 - RF Analysis > Channel Power, Occupied BW, Spectrum Emission Mask, or Spurious Emissions
 - Power vs Time (Frame)
 - Modulation Analysis > Constellation, Spectral Flatness, EVM vs Subcarrier, or EVM vs. Symbol
 - Auto Measure
 - Power Statistics CCDF
 - OTA > Preamble Scanner, Multipath Profile, Preamble Power Trend, or Route Map
-

Configuring test parameters

Setting frequency

You can set the frequency with either frequency or channel number. If a frequency to be set matches to the frequency corresponding to the selected channel standard, the instrument calculates its channel number and updates the screen with it automatically.

Procedure

To set the center frequency:

1. Press the **FREQ/DIST** hard key.
2. Toggle the **Unit** soft key and select **Freq**.
3. Press the **Center Frequency** soft key.
4. Enter a value by using the numeric keys. You can also use the rotary knob.
5. Select the unit: **GHz**, **MHz**, **kHz**, or **Hz**.
6. *Optional.* To define the amount of frequency increment for the rotary knob, complete the following steps:
 - a. Press the **Frequency Step** soft key.
 - b. Enter a value by using the numeric keys. You can also use the rotary knob.
 - c. Press the unit: **GHz**, **MHz**, **kHz**, or **Hz**.

To set the channel number:

1. Press the **FREQ/DIST** hard key.
 2. Toggle the **Unit** soft key and select **Channel**.
 3. To select the standard channel, complete the following steps:
 - a. Press the **Channel Std** soft key. The standard channel window appears.
-

See “Appendix C – Band, frequency & channel standard” on page 541 for more information.

- b. Select the band to be measured by using the rotary knob, the arrow keys, or the **Page Up/Page Down** soft keys.
 - c. Press the **Select** soft key or the rotary knob to confirm the selection.
4. Press the **Channel Number** soft key.
 5. Enter a value by using the numeric keys. You can also use the rotary knob.
 6. Press the **Enter** soft key.

The instrument automatically displays the corresponding center frequency value for the selected channel number.

7. *Optional.* To define the amount of channel increment for the rotary knob, complete the following steps:
 - a. Press the **Channel Step** soft key.
 - b. Enter a value by using the numeric keys. You can also use the rotary knob.
 - c. Press the **Enter** soft key.

NOTE

This frequency setting is not used in the Spurious Emissions mode.

Setting amplitude

Reference level and attenuation

You can set the reference and attenuation levels automatically or manually to optimize the display of the traces measured, as you desire.

Procedure

To automatically set the reference and attenuation level:

1. Press the **AMP/SCALE** hard key.
2. Press the **Auto Scale** soft key.
Each time you press this key, both of the Y-axis scale and input attenuation level change to be optimized with some margin.

To set the reference or attenuation level manually:

1. Press the **AMP/SCALE** hard key.
2. To set the maximum reference value on the Y-axis manually, complete the following steps:
 - a. Press the **Reference Level** soft key.
 - b. Enter a value by using the numeric keys or the rotary knob with 10 dB increments.
 - c. Press the **dBm** soft key or the **ENTER** hard key.

NOTE

In the measurements such as **Midamble Power**, **Code Power**, and **Code Error**, you may need to select the reference option between **Relative** and **Absolute** before setting the reference level.

3. To set the attenuation option, select one from the following choices:
 - To set the input attenuator’s level automatically, select **Attenuation > Auto**.

NOTE

It is recommended that you set the **Attenuation to Auto** in most situations so that the level of the input attenuator can be set automatically according to your input signal level.

- To set the input attenuation manually up to 55 dB to optimize S/N, complete the following steps:
 - a. Select **Attenuation > Manual**.
 - b. Press the **Attenuation Value** soft key to set the level.
 - c. Enter a value between 0 and 55 in fives by using the numeric keys.
 - d. Press the **dB** soft key or the **ENTER** hard key.
- To couple the input attenuator's level with your reference level setting, select **Attenuation > Couple**.
As you increase the reference setting, the attenuation level also increases accordingly.

Optional. To change the scale unit:

1. Select **More (1/2) > Units**.
2. Select the unit of the display scale: **dBm**, **dBV**, **dBmV**, **dBμV**, **V**, or **W**.
The scale unit on the screen changes accordingly.

NOTE

This Units menu is available in the Spectrum and RF Analysis modes.

Scale per division

You can use the **Scale/Div** feature available for the spectrum and RF analysis. It represents the value of one division on the horizontal scale. The default setting is 10 dB per division and the maximum value can be set up to 20 dB.

Procedure

To set the scale per division:

1. Press the **AMP/SCALE** hard key.
2. Select **More (1/2) > Scale/Div**.
3. Enter a value between 1 and 20 by using the numeric keys.
4. Press the **dB** soft key to complete the entry.

Pre-amplifier

You can turn the internal pre-amplifier on to correct and compensate for the gain of the preamp so that amplitude readings show the value at the input connector.

Procedure

1. Press the **AMP/SCALE** hard key.
2. Toggle the **Preamp** soft key and select **On** or **Off** as needed.

NOTE

You can turn the Preamp on when the input attenuation range is from 0 dB to 10 dB. If the attenuation value is manually set to greater than 10 dB, the instrument will automatically turn off the pre-amplifier to display low-level signal properly on the chart.

External offset

You can turn the **External Offset** on and manually set the external offset value. An offset consists of a cable loss and a user offset and the measurement result shows the value reflecting both offset values. When the external offset value is set at 40 dB in the Spectrum mode, the measurement result compensates 40 dB at both the Spectrum Analyzer and Signal Analyzer modes

Procedure

To set the external offset:

1. Press the **AMP/SCALE** hard key.
2. Toggle the **External Offset** soft key and select **On**.
3. Enter a value by using the numeric keys.
4. Press the **dB** soft key to complete the entry.

To turn the external offset off:

1. Press the **AMP/SCALE** hard key.
 2. Toggle the **External Offset** soft key and select **Off**.
-

Setting average

You can set the number of measurements to be averaged for the trace presentation. A maximum of 100 times of averaging can be set. When the averaging reaches to your setting, a new measurement value replaces the measurement value in sequence from the earliest.

Procedure

1. Press the **BW/AVG** hard key.
 2. Press the **Average** soft key.
 3. Enter a value between 1 and 100 as needed by using the numeric keys.
 4. Press the **Enter** soft key.
-

Setting sweep mode

The default settings of the sweep mode are **Continue** and **Normal** to sweep continuously at a normal speed for most on-going measurements. If you want to hold the measurement or get a single sweep, you can change the sweep mode.

Procedure

To select the single sweep mode:

1. Press the **SWEEP** hot key.
2. Toggle the **Sweep Mode** soft key and select **Single**. You can also use the **HOLD** hot key. The letter **HOLD** in red appears and the sweeping is paused.
3. *Optional.* Press the **Sweep Once** soft key to get a new measurement.

To return to the continuous sweep mode:

1. Toggle the **Sweep Mode** soft key and select **Continue**. You can also use the **HOLD** hot key. The letter **HOLD** in red disappears and the sweeping resumes.
-

Setting trigger source

You can set the trigger source option for your measurements.

Procedure

1. Press the **TRIGGER** hot key.
2. Select the trigger source option from the following choices: **Internal**, **External**, or **GPS**.

Setting external clock

To enhance the reliability of modulation analysis measurements the JD780A series must be synchronized with a base station. When an external clock is not supplied, the instrument works with its built-in internal high-accuracy time base and some measurement results may exhibit inaccurate values. Therefore, it is highly recommended that you use the same reference clock as the signal source. You can use the **TRIGGER** hot key to set the external clock.







Figure 215 Connection ports for external reference clock



Procedure

1. Connect an external reference or a GPS antenna to the JD780A series.
2. Press the **SYSTEM** hot key.
3. Press the **Freq Reference** soft key, and then select the reference option: **Internal**, **External 10 MHz**, **External 13 MHz**, **External 15 MHz**, or **GPS**.

Table 21 External reference indicators

Type	Indicator	Description
Internal	 (green)	The green INT icon indicates that the instrument uses the built-in internal time base.
External	 (green)	The green EXT icon indicates that an external reference is connected and locked and that the instrument uses the same reference clock as the signal source.
External	 (red)	The red EXT icon indicates that an external reference is connect but not locked.
GPS	 (green)	The green GPS antenna icon indicates that a GPS antenna is connected and locked.
GPS	 (yellow)	The yellow GPS antenna icon indicates that a GPS antenna is connected and locking is in progress.
GPS	 (grey)	The grey GPS antenna icon indicates that a GPS antenna is not connected, failed, or unable to be locked.

Conducting spectrum measurements

Setting measure setup

After configuring test parameters as described in the “Configuring test parameters” on page 427, you can continue your measurement.

Procedure

1. Press the **MEASURE SETUP** hot key.
2. Press the **System Config** soft key, and then do the following:
 - a. Press the **Bandwidth** soft key, and then select the nominal channel bandwidth to be measured from the following choices:
 - **7 MHz (8/7)**: Sets the channel bandwidth to 7 MHz with sampling factor 8/7. In conjunction with nominal channel bandwidth
 - **8.75 MHz (8/7)**: Sets the channel bandwidth to 8.75 MHz with sampling factor 8/7
 - **10 MHz (28/25)**: Sets the channel bandwidth to 10 MHz with sampling factor 28/25
 - b. Toggle the **Frame Length** soft key and select **5 ms** or **10 ms**.
 - c. Press the **TTG (RTG)** soft key to set the transmit/receive transition gap between the last sample of the downlink burst and the first sample of the subsequent uplink burst.
 - d. Enter a value by using the numeric keys, and then press the **Enter** soft key.
 - e. Press the **CP Ratio** soft key, and then select the cyclic prefix ratio option: **1/4**, **1/8**, **1/16**, or **1/32**.
 - f. Press the **DL Symbols** soft key to set the number of downlink symbols.
 - g. Enter a value by using the numeric keys, and then press the **Enter** soft key.
 - h. Press the **UL Symbols** soft key to set the number of uplink symbols.
 - i. Enter a value by using the numeric keys, and then press the **Enter** soft key.
3. *Optional.* To set the delay, complete the following steps:
 - a. Press the **Delay** soft key to set the amount of delay in μs .
 - b. Enter a value by using the numeric keys. You can also use the rotary knob.
 - c. Press the **μs** soft key.

NOTE

The Delay setting is used only when there is a time offset in the signals to be measured.

Your measurement result is displayed on the screen as like the following example, Figure 216.

Figure 216 Spectrum measurement screen with Mobile WiMAX signal analyzer



Setting trace

You can display up to six traces on the measurement chart simultaneously.

Procedure

1. Press the **TRACE/DISPLAY** hard key.
2. Press the **Select Trace** soft key, and then select the trace number: **T1**, **T2**, **T3**, **T4**, **T5**, or **T6**. The legend shape of the selected trace changes from square to round to indicate that the trace is the active one now.
3. Toggle the **Trace View** soft key and select **On**.
4. To clear, write or capture, or hide the trace(s), do one of the following:

To	Select	Trace Legend
Clear current data and display with new measurements	Clear Write	W
Display the input signal's maximum response only	Max Hold	M
Display the input signal's minimum response only	Min Hold	m
Capture the selected trace and compare traces	Capture	C
Load a saved trace	More (1/2) > Load	L
Hide the selected trace	Trace View > Off	F
Remove all the traces and initialize the trace settings	More (1/2) > Trace Clear All	

5. *Optional.* Press the **More (1/2) > Trace Info** soft key, and then select the trace number to view the trace's parameter setting information stored at the time of the measurement or **None** to hide the information display.
6. *Optional.* If you have the two traces T1 and T2, you can perform trace math. To view the power difference between the traces, press the **T1 – T2 -> T5** or **T2 – T1 -> T6** soft key. The result is overlaid on the screen along with the second Y-axis.

Conducting RF measurements

Channel power

The Channel Power measurement is a common test used in the wireless industry to measure the total transmitted power of a radio within a defined frequency channel. It acquires a number of points representing the input signal in the time domain, transforms this information into the frequency domain using Fast Fourier Transform (FFT), and then calculates the channel power. The effective resolution bandwidth of the frequency domain trace is proportional to the number of points acquired for the FFT.

The channel power measurement identifies the total RF power, power spectral density (PSD) and peak to average ratio (PAR) of the signal in the Mobile WiMAX channel bandwidth.

Setting measure setup

After configuring test parameters as described in the “Configuring test parameters” on page 427, you can continue your measurement.

Procedure

1. Press the **MEASURE SETUP** hot key.
2. Press the **System Config** soft key, and then do the following:
 - a. Press the **Bandwidth** soft key, and then select the nominal channel bandwidth to be measured from the following choices:
 - **7 MHz (8/7)**: Sets the channel bandwidth to 7 MHz with sampling factor 8/7. In conjunction with nominal channel bandwidth
 - **8.75 MHz (8/7)**: Sets the channel bandwidth to 8.75 MHz with sampling factor 8/7
 - **10 MHz (28/25)**: Sets the channel bandwidth to 10 MHz with sampling factor 28/25
 - b. Toggle the **Frame Length** soft key and select **5 ms** or **10 ms**.
 - c. Press the **TTG (RTG)** soft key to set the transmit/receive transition gap between the last sample of the downlink burst and the first sample of the subsequent uplink burst.
 - d. Enter a value by using the numeric keys, and then press the **Enter** soft key.
 - e. Press the **CP Ratio** soft key, and then select the cyclic prefix ratio option: **1/4**, **1/8**, **1/16**, or **1/32**.
 - f. Press the **DL Symbols** soft key to set the number of downlink symbols.
 - g. Enter a value by using the numeric keys, and then press the **Enter** soft key.
 - h. Press the **UL Symbols** soft key to set the number of uplink symbols.
 - i. Enter a value by using the numeric keys, and then press the **Enter** soft key.
3. *Optional.* To set the delay, complete the following steps:
 - a. Press the **Delay** soft key to set the amount of delay in μs .
 - b. Enter a value by using the numeric keys. You can also use the rotary knob.
 - c. Press the **μs** soft key.

NOTE

The Delay setting is used only when there is a time offset in the signals to be measured.

4. To set the start/stop symbols, complete the following steps:
 - a. Press the **Start Symbol** soft key.
 - b. Enter a value by using the numeric keys, and then press the **Enter** soft key.
-

- c. Press the **Stop Symbol** soft key.
- d. Enter a value by using the numeric keys, and then press the **Enter** soft key.

Measurement example

Figure 217 Channel power measurement with Mobile WiMAX signal analyzer



NOTE

You can use the **LIMIT** hot key to analyze your measurements with the user-definable limit and Pass/Fail indication. See “Setting limit for RF tests” on page 440 for more information.

Occupied bandwidth

The Occupied Bandwidth measures the spectrum shape of the carrier. It is defined as the bandwidth, which includes 99% of the transmitted power among total transmitted power.

Setting measure setup

After configuring test parameters as described in the “Configuring test parameters” on page 427, you can continue your measurement.

Procedure

1. Press the **MEASURE SETUP** hot key.
2. Press the **System Config** soft key, and then do the following:
 - a. Press the **Bandwidth** soft key, and then select the nominal channel bandwidth to be measured from the following choices:
 - **7 MHz (8/7)**: Sets the channel bandwidth to 7 MHz with sampling factor 8/7. In conjunction with nominal channel bandwidth
 - **8.75 MHz (8/7)**: Sets the channel bandwidth to 8.75 MHz with sampling factor 8/7
 - **10 MHz (28/25)**: Sets the channel bandwidth to 10 MHz with sampling factor 28/25
 - b. Toggle the **Frame Length** soft key and select **5 ms** or **10 ms**.

- c. Press the **TTG (RTG)** soft key to set the transmit/receive transition gap between the last sample of the downlink burst and the first sample of the subsequent uplink burst.
 - d. Enter a value by using the numeric keys, and then press the **Enter** soft key.
 - e. Press the **CP Ratio** soft key, and then select the cyclic prefix ratio option: **1/4**, **1/8**, **1/16**, or **1/32**.
 - f. Press the **DL Symbols** soft key to set the number of downlink symbols.
 - g. Enter a value by using the numeric keys, and then press the **Enter** soft key.
 - h. Press the **UL Symbols** soft key to set the number of uplink symbols.
 - i. Enter a value by using the numeric keys, and then press the **Enter** soft key.
3. *Optional.* To set the delay, complete the following steps:
- a. Press the **Delay** soft key to set the amount of delay in μ s.
 - b. Enter a value by using the numeric keys. You can also use the rotary knob.
 - c. Press the **μ s** soft key.

NOTE

The Delay setting is used only when there is a time offset in the signals to be measured.

4. To set the start/stop symbols, complete the following steps:
- a. Press the **Start Symbol** soft key.
 - b. Enter a value by using the numeric keys, and then press the **Enter** soft key.
 - c. Press the **Stop Symbol** soft key.
 - d. Enter a value by using the numeric keys, and then press the **Enter** soft key.

Measurement example

Figure 218 Occupied bandwidth measurement with Mobile WiMAX signal analyzer



NOTE

You can use the **LIMIT** hot key to analyze your measurements with the user-definable limit and Pass/Fail indication. See “Setting limit for RF tests” on page 440 for more information.

Spectrum emission mask (SEM)

The Spectrum Emission Mask (SEM) measurement compares the total power level within the defined carrier bandwidth and the given offset channels according to the standards.

Setting measure setup

After configuring test parameters as described in the “Configuring test parameters” on page 427, you can continue your measurement.

Procedure

1. Press the **MEASURE SETUP** hot key.
2. Press the **System Config** soft key, and then do the following:
 - a. Press the **Bandwidth** soft key, and then select the nominal channel bandwidth to be measured from the following choices:
 - **7 MHz (8/7)**: Sets the channel bandwidth to 7 MHz with sampling factor 8/7. In conjunction with nominal channel bandwidth
 - **8.75 MHz (8/7)**: Sets the channel bandwidth to 8.75 MHz with sampling factor 8/7
 - **10 MHz (28/25)**: Sets the channel bandwidth to 10 MHz with sampling factor 28/25
 - b. Toggle the **Frame Length** soft key and select **5 ms** or **10 ms**.
 - c. Press the **TTG (RTG)** soft key to set the transmit/receive transition gap between the last sample of the downlink burst and the first sample of the subsequent uplink burst.
 - d. Enter a value by using the numeric keys, and then press the **Enter** soft key.
 - e. Press the **CP Ratio** soft key, and then select the cyclic prefix ratio option: **1/4**, **1/8**, **1/16**, or **1/32**.
 - f. Press the **DL Symbols** soft key to set the number of downlink symbols.
 - g. Enter a value by using the numeric keys, and then press the **Enter** soft key.
 - h. Press the **UL Symbols** soft key to set the number of uplink symbols.
 - i. Enter a value by using the numeric keys, and then press the **Enter** soft key.
3. *Optional.* To set the delay, complete the following steps:
 - a. Press the **Delay** soft key to set the amount of delay in μs .
 - b. Enter a value by using the numeric keys. You can also use the rotary knob.
 - c. Press the **μs** soft key.

NOTE

The Delay setting is used only when there is a time offset in the signals to be measured.

4. To set the start/stop symbols, complete the following steps:
 - a. Press the **Start Symbol** soft key.
 - b. Enter a value by using the numeric keys, and then press the **Enter** soft key.
 - c. Press the **Stop Symbol** soft key.
 - d. Enter a value by using the numeric keys, and then press the **Enter** soft key.
-

Measurement example

Figure 219 SEM measurement with Mobile WiMAX signal analyzer



NOTE

You can use the **LIMIT** hot key to analyze your measurements with the user-definable limit and Pass/Fail indication. See “Setting limit for RF tests” on page 440 for more information.

Spurious emissions

Out-of-band emissions are unwanted emissions immediately outside the channel bandwidth resulting from the modulation process and non-linearity in the transmitter but excluding spurious emissions. The Spurious Emissions measurement is to identify and determine the power level of out-of-band spurious emission within the necessary channel bandwidth and modulated signal measured at the RF port of the Base Station.

Setting measure setup

After configuring test parameters as described in the “Configuring test parameters” on page 427, you can continue your measurement.

Procedure

1. Press the **MEASURE SETUP** hot key.
2. To set up the range table and frequency range, press the **Range Table** soft key and then complete the following steps:
 - a. Press the **Range** soft key, and then enter the range number to add a new range or change an existing one.
 - b. Press the **Enter** soft key.
 - c. Press the **Start Frequency** soft key to set up the frequency range.
 - d. Enter a value by using the numeric keys. You can also use the rotary knob.
 - e. Select the unit: **GHz**, **MHz**, **kHz**, or **Hz**.
 - f. Press the **Stop Frequency** soft key to set up the frequency range.

-
- g. Enter a value by using the numeric keys. You can also use the rotary knob.
 - h. Select the unit: **GHz**, **MHz**, **kHz**, or **Hz**.
3. Toggle the **Range** soft key between **On** and **Off** to display or hide the selected range.
 4. To set up the test limits for Pass/Fail indication, complete the following steps:
 - a. Press the **Start Limit** soft key.
 - b. Enter a value by using the numeric keys. You can also use the rotary knob.
 - c. Select the **dBm** soft key.
 - d. Press the **Stop Limit** soft key.
 - e. Enter a value by using the numeric keys. You can also use the rotary knob.
 - f. Select the **dBm** soft key.
 5. To set up the other dB parameters, complete the following steps:
 - a. Select **More (1/2) > Attenuation** to set up the attenuation value.
 - b. Enter a value in the multiple of five.
 - c. Press the **dB** soft key or the **ENTER** hard key.
 - d. Press the **RBW** soft key.
 - e. Enter a value by using the numeric keys.
 - f. Select the unit: **GHz**, **MHz**, **kHz**, or **Hz**.
 - g. Press the **VBW** soft key.
 - h. Enter a value by using the numeric keys.
 - i. Select the unit: **GHz**, **MHz**, **kHz**, or **Hz**.
 6. Press the **PREV** hard key.
 7. Toggle the **Measure Type** soft key between **Examine** and **Full** to select the measurement type.

NOTE

The **Examine** mode displays only the selected range while the **Full** mode lets the instrument automatically changes the selected range from one another.

8. Set the number of measurements to be averaged:
 - a. Press the **Average** soft key.
 - b. Enter a value between 1 and 100.
 - c. Press the **Enter** soft key.
-

Measurement example

Figure 220 Spurious emissions measurement with Mobile WiMAX signal analyzer



NOTE

You can use the **LIMIT** hot key to analyze your measurements with the user-definable limit and Pass/Fail indication. See “Setting limit for RF tests” on page 440 for more information.

Setting limit for RF tests

By default, test limits specified in the standard are set for you. You can change thresholds if you desire.

Procedure

1. Press the **LIMIT** hot key.
2. Press the **RF Test Limits** soft key.
3. Select the test item(s) and set the limit(s) depending on your selected measurement mode:

To set the limit for	Select	Set
Channel power	Channel Power	High Limit Low Limit
Occupied bandwidth	Occupied BW	High Limit
Spectrum emission mask	Spectrum Emission Mask	(On/Off only)
Spurious emissions	Spurious Emissions	(On/Off only)

4. *Optional.* You can enable alarm sound that goes off if the measurement falls outside of the limit. Toggle the **Beep** soft key between **On** and **Off** to enable or disable the beep sound.
5. *Optional.* Go to **SAVE/LOAD > Save**, and then select **Limit** to save the limit settings. See “Using save” on page 31 for more information.

Conducting power vs. time (frame) measurements

The Power vs. Time (Frame) measures the modulation envelope in the time domain, showing the power of each time slot in a Mobile WiMAX signal.

Setting measure setup

After configuring test parameters as described in the “Configuring test parameters” on page 427, you can continue your measurement. The measurement settings can be saved and recalled as a file.

Procedure

1. Press the **MEASURE SETUP** hot key.
2. Press the **System Config** soft key, and then do the following:
 - a. Press the **Bandwidth** soft key, and then select the nominal channel bandwidth to be measured from the following choices:
 - **7 MHz (8/7)**: Sets the channel bandwidth to 7 MHz with sampling factor 8/7. In conjunction with nominal channel bandwidth
 - **8.75 MHz (8/7)**: Sets the channel bandwidth to 8.75 MHz with sampling factor 8/7
 - **10 MHz (28/25)**: Sets the channel bandwidth to 10 MHz with sampling factor 28/25
 - b. Toggle the **Frame Length** soft key and select **5 ms** or **10 ms**.
 - c. Press the **TTG (RTG)** soft key to set the transmit/receive transition gap between the last sample of the downlink burst and the first sample of the subsequent uplink burst.
 - d. Enter a value by using the numeric keys, and then press the **Enter** soft key.
 - e. Press the **CP Ratio** soft key, and then select the cyclic prefix ratio option: **1/4**, **1/8**, **1/16**, or **1/32**.
 - f. Press the **DL Symbols** soft key to set the number of downlink symbols.
 - g. Enter a value by using the numeric keys, and then press the **Enter** soft key.
 - h. Press the **UL Symbols** soft key to set the number of uplink symbols.
 - i. Enter a value by using the numeric keys, and then press the **Enter** soft key.
3. To set the start/stop symbols, complete the following steps:
 - a. Press the **Start Symbol** soft key.
 - b. Enter a value by using the numeric keys, and then press the **Enter** soft key.
 - c. Press the **Stop Symbol** soft key.
 - d. Enter a value by using the numeric keys, and then press the **Enter** soft key.
4. Toggle the **Preamble Index** soft key and select the preamble search method: **Auto** or **Manual**.
5. Toggle the **Search Type** soft key and select **Full** or **Window**.
6. Toggle the **Video Filter** soft key and select **On** or **Off** to enable or disable the video filter.
7. *Optional.* Press the **Miscellaneous** soft key, and then do the following as needed:
 - To set the delay, complete the following steps:
 - a. Press the **Delay** soft key to set the amount of delay in μs .
 - b. Enter a value by using the numeric keys. You can also use the rotary knob.
 - c. Press the **μs** soft key.

NOTE

The Delay setting is used only when there is a time offset in the signals to be measured.

- To select the detect mode, press the **Detect Mode** soft key and then select the option: **Auto, QPSK, 16 QAM, or 64 QAM.**

Setting limit for power vs. time tests

Procedure

1. Press the **LIMIT** hot key.
2. Press the **PvsT Test Limits** soft key.
3. Select the test item(s) and set the limit(s):

To set the limit for	Select	Set
Preamble power	Preamble Power	High Limit, Low Limit
Downlink burst power	DL Burst Power	High Limit, Low Limit
Uplink burst power	UL Burst Power	High Limit, Low Limit
Frame average power	Frame Average Power	High Limit, Low Limit
Time offset	Time Offset	High Limit, Low Limit
I/Q origin offset	IQ Origin Offset	High Limit

4. *Optional.* You can enable alarm sound that goes off if the measurement falls outside of the limit. Toggle the **Beep** soft key between **On** and **Off** to enable or disable the beep sound.
5. *Optional.* Go to **SAVE/LOAD > Save**, and then select **Limit** to save the limit settings. See "Using save" on page 31 for more information.

Measurement example

Figure 221 Power vs. time (frame) measurement with Mobile WiMAX signal analyzer



Conducting modulation measurements

Constellation

The Constellation is used to observe some aspects of modulation accuracy and can reveal certain fault mechanisms such as I/Q amplitude imbalance or quadrature imbalance. It displays constellation diagram by modulation types.

Setting measure setup

After configuring test parameters as described in the “Configuring test parameters” on page 427, you can continue your measurement. The measurement settings can be saved and recalled as a file. You can also use JDViewer, PC application software to configure a measure setup, save as a file, and load the file on to the instrument.

Procedure

1. Press the **MEASURE SETUP** hot key.
 2. Press the **System Config** soft key, and then do the following:
 - a. Press the **Bandwidth** soft key, and then select the nominal channel bandwidth to be measured from the following choices:
 - **7 MHz (8/7)**: Sets the channel bandwidth to 7 MHz with sampling factor 8/7. In conjunction with nominal channel bandwidth
 - **8.75 MHz (8/7)**: Sets the channel bandwidth to 8.75 MHz with sampling factor 8/7
 - **10 MHz (28/25)**: Sets the channel bandwidth to 10 MHz with sampling factor 28/25
 - b. Toggle the **Frame Length** soft key and select **5 ms** or **10 ms**.
 - c. Press the **TTG (RTG)** soft key to set the transmit/receive transition gap between the last sample of the downlink burst and the first sample of the subsequent uplink burst.
 - d. Enter a value by using the numeric keys, and then press the **Enter** soft key.
 - e. Press the **CP Ratio** soft key, and then select the cyclic prefix ratio option: **1/4**, **1/8**, **1/16**, or **1/32**.
 - f. Press the **DL Symbols** soft key to set the number of downlink symbols.
 - g. Enter a value by using the numeric keys, and then press the **Enter** soft key.
 - h. Press the **UL Symbols** soft key to set the number of uplink symbols.
 - i. Enter a value by using the numeric keys, and then press the **Enter** soft key.
 3. To set the start/stop symbols, complete the following steps:
 - a. Press the **Start/Stop Symbol** soft key.
 - b. Enter a value by using the numeric keys, and then press the **Enter** soft key.
 4. Toggle the **Preamble Index** soft key and select the preamble search method: **Auto** or **Manual**.
 5. Toggle the **Search Type** soft key and select **Full** or **Window**.
 6. *Optional.* Press the **Miscellaneous** soft key, and then do the following as needed:
 - To select the detect mode, press the **Detect Mode** soft key and then select the option: **Auto**, **QPSK**, **16 QAM**, or **64 QAM**.
 - To select the downlink zone, press the **DL Zone** soft key and then select the permutation zone option: **Auto**, **PUSC** for partial usage of subcarrier channels, **FUSC** for full usage of subcarrier channels, or **AMC2X3** for adaptive modulation and coding.
-

NOTE

The permutation zone that is a number of contiguous OFDMA symbols in downlink that use the same permutation. The DL subframe may contain more than one permutation zone. The maximum number of DL zone is 8 in one DL subframe.

- To set the delay, complete the following steps:
 - a. Press the **Delay** soft key to set the amount of delay in μs .
 - b. Enter a value by using the numeric keys. You can also use the rotary knob.
 - c. Press the **μs** soft key.

NOTE

The Delay setting is used only when there is a time offset in the signals to be measured.

Measurement example

Figure 222 Constellation measurement with Mobile WiMAX signal analyzer



NOTE

You can use the **LIMIT** hot key to analyze your measurements with the user-definable limit and Pass/Fail indication. See “Setting limit for modulation tests” on page 450 for more information. The Spectral Flatness is not used in the Constellation mode.

Spectral flatness

The Spectral Flatness is used to measure the flatness energy of the constellation according to the WiMAX specification IEEE 802.16e.

Setting measure setup

After configuring test parameters as described in the “Configuring test parameters” on page 427, you can continue your measurement. The measurement settings can be saved and recalled as a file. You can also use JDViewer, PC application software to configure a measure setup, save as a file, and load the file on to the instrument.

Procedure

1. Press the **MEASURE SETUP** hot key.
2. Press the **System Config** soft key, and then do the following:
 - a. Press the **Bandwidth** soft key, and then select the nominal channel bandwidth to be measured from the following choices:
 - **7 MHz (8/7)**: Sets the channel bandwidth to 7 MHz with sampling factor 8/7. In conjunction with nominal channel bandwidth
 - **8.75 MHz (8/7)**: Sets the channel bandwidth to 8.75 MHz with sampling factor 8/7
 - **10 MHz (28/25)**: Sets the channel bandwidth to 10 MHz with sampling factor 28/25
 - b. Toggle the **Frame Length** soft key and select **5 ms** or **10 ms**.
 - c. Press the **TTG (RTG)** soft key to set the transmit/receive transition gap between the last sample of the downlink burst and the first sample of the subsequent uplink burst.
 - d. Enter a value by using the numeric keys, and then press the **Enter** soft key.
 - e. Press the **CP Ratio** soft key, and then select the cyclic prefix ratio option: **1/4**, **1/8**, **1/16**, or **1/32**.
 - f. Press the **DL Symbols** soft key to set the number of downlink symbols.
 - g. Enter a value by using the numeric keys, and then press the **Enter** soft key.
 - h. Press the **UL Symbols** soft key to set the number of uplink symbols.
 - i. Enter a value by using the numeric keys, and then press the **Enter** soft key.
3. To set the start/stop symbols, complete the following steps:
 - a. Press the **Start Symbol** soft key.
 - b. Enter a value by using the numeric keys, and then press the **Enter** soft key.
 - c. Press the **Stop Symbol** soft key.
 - d. Enter a value by using the numeric keys, and then press the **Enter** soft key.
4. Toggle the **Preamble Index** soft key and select the preamble search method: **Auto** or **Manual**.
5. Toggle the **Search Type** soft key and select **Full** or **Window**.
6. *Optional.* Press the **Miscellaneous** soft key, and then do the following as needed:
 - To select the detect mode, press the **Detect Mode** soft key and then select the option: **Auto**, **QPSK**, **16 QAM**, or **64 QAM**.
 - To select the downlink zone, press the **DL Zone** soft key and then select the permutation zone option: **Auto**, **PUSC** for partial usage of subcarrier channels, **FUSC** for full usage of subcarrier channels, or **AMC2X3** for adaptive modulation and coding.

NOTE

The permutation zone, which is a number of contiguous OFDMA, symbols in downlink that use the same permutation. The DL subframe may contain more than one permutation zone. The maximum number of DL zone is 8 in one DL subframe.

- To set the delay, complete the following steps:
 - a. Press the **Delay** soft key to set the amount of delay in μs .
 - b. Enter a value by using the numeric keys. You can also use the rotary knob.
 - c. Press the **μs** soft key.

NOTE

The Delay setting is used only when there is a time offset in the signals to be measured.

Measurement example

Figure 223 Spectral flatness measurement with Mobile WiMAX signal analyzer



NOTE

You can use the **LIMIT** hot key to analyze your measurements with the user-definable limit and Pass/Fail indication for the Spectral Flatness. See “Setting limit for modulation tests” on page 450 for more information.

EVM vs. subcarrier

The EVM vs Subcarrier shows the error vector magnitude representing the average constellation error of WiMAX OFDMA subcarriers.

Setting measure setup

After configuring test parameters as described in the “Configuring test parameters” on page 427, you can continue your measurement. The measurement settings can be saved and recalled as a file. You can also use JDViewer, PC application software to configure a measure setup, save as a file, and load the file on to the instrument.

Procedure

1. Press the **MEASURE SETUP** hot key.
2. Press the **System Config** soft key, and then do the following:
 - a. Press the **Bandwidth** soft key, and then select the nominal channel bandwidth to be measured from the following choices:
 - **7 MHz (8/7)**: Sets the channel bandwidth to 7 MHz with sampling factor 8/7. In conjunction with nominal channel bandwidth
 - **8.75 MHz (8/7)**: Sets the channel bandwidth to 8.75 MHz with sampling factor 8/7
 - **10 MHz (28/25)**: Sets the channel bandwidth to 10 MHz with sampling factor 28/25
 - b. Toggle the **Frame Length** soft key and select **5 ms** or **10 ms**.
 - c. Press the **TTG (RTG)** soft key to set the transmit/receive transition gap between the last sample of the downlink burst and the first sample of the subsequent uplink burst.

-
- d. Enter a value by using the numeric keys, and then press the **Enter** soft key.
 - e. Press the **CP Ratio** soft key, and then select the cyclic prefix ratio option: **1/4**, **1/8**, **1/16**, or **1/32**.
 - f. Press the **DL Symbols** soft key to set the number of downlink symbols.
 - g. Enter a value by using the numeric keys, and then press the **Enter** soft key.
 - h. Press the **UL Symbols** soft key to set the number of uplink symbols.
 - i. Enter a value by using the numeric keys, and then press the **Enter** soft key.
3. To set the start/stop symbols, complete the following steps:
 - a. Press the **Start/Stop Symbol** soft key.
 - b. Enter a value by using the numeric keys, and then press the **Enter** soft key.
 4. Toggle the **Preamble Index** soft key and select the preamble search method: **Auto** or **Manual**.
 5. Toggle the **Search Type** soft key and select **Full** or **Window**.
 6. *Optional.* Press the **Miscellaneous** soft key, and then do the following as needed:
 - To select the detect mode, press the **Detect Mode** soft key and then select the option: **Auto**, **QPSK**, **16 QAM**, or **64 QAM**.
 - To select the downlink zone, press the **DL Zone** soft key and then select the permutation zone option: **Auto**, **PUSC** for partial usage of subcarrier channels, **FUSC** for full usage of subcarrier channels, or **AMC2X3** for adaptive modulation and coding.

NOTE

The permutation zone, which is a number of contiguous OFDMA symbols in downlink that use the same permutation. The DL subframe may contain more than one permutation zone. The maximum number of DL zone is 8 in one DL subframe.

- To set the delay, complete the following steps:
 - a. Press the **Delay** soft key to set the amount of delay in μs .
 - b. Enter a value by using the numeric keys. You can also use the rotary knob.
 - c. Press the **μs** soft key.

NOTE

The Delay setting is used only when there is a time offset in the signals to be measured.

Measurement example

Figure 224 EVM vs. subcarrier measurement with Mobile WiMAX signal analyzer



NOTE

You can use the **LIMIT** hot key to analyze your measurements with the user-definable limit and Pass/Fail indication. See “Setting limit for modulation tests” on page 450 for more information. The Spectral Flatness and Frequency Error are not used in the EVM vs. Subcarrier mode.

EVM vs. symbol

The EVM vs Symbol is used to show the error vector magnitude representing the average constellation error of WiMAX OFDMA symbols.

Setting measure setup

After configuring test parameters as described in the “Configuring test parameters” on page 427, you can continue your measurement. The measurement settings can be saved and recalled as a file. You can also use JDViewer, PC application software to configure a measure setup, save as a file, and load the file on to the instrument.

Procedure

1. Press the **MEASURE SETUP** hot key.
2. Press the **System Config** soft key, and then do the following:
 - a. Press the **Bandwidth** soft key, and then select the nominal channel bandwidth to be measured from the following choices:
 - **7 MHz (8/7)**: Sets the channel bandwidth to 7 MHz with sampling factor 8/7. In conjunction with nominal channel bandwidth
 - **8.75 MHz (8/7)**: Sets the channel bandwidth to 8.75 MHz with sampling factor 8/7
 - **10 MHz (28/25)**: Sets the channel bandwidth to 10 MHz with sampling factor 28/25
 - b. Toggle the **Frame Length** soft key and select **5 ms** or **10 ms**.
 - c. Press the **TTG (RTG)** soft key to set the transmit/receive transition gap between the last sample of the downlink burst and the first sample of the subsequent uplink burst.

-
- d. Enter a value by using the numeric keys, and then press the **Enter** soft key.
 - e. Press the **CP Ratio** soft key, and then select the cyclic prefix ratio option: **1/4**, **1/8**, **1/16**, or **1/32**.
 - f. Press the **DL Symbols** soft key to set the number of downlink symbols.
 - g. Enter a value by using the numeric keys, and then press the **Enter** soft key.
 - h. Press the **UL Symbols** soft key to set the number of uplink symbols.
 - i. Enter a value by using the numeric keys, and then press the **Enter** soft key.
3. To set the start/stop symbols, complete the following steps:
 - a. Press the **Start/Stop Symbol** soft key.
 - b. Enter a value by using the numeric keys, and then press the **Enter** soft key.
 4. Toggle the **Preamble Index** soft key and select the preamble search method: **Auto** or **Manual**.
 5. Toggle the **Search Type** soft key and select **Full** or **Window**.
 6. *Optional.* Press the **Miscellaneous** soft key, and then do the following as needed:
 - To select the detect mode, press the **Detect Mode** soft key and then select the option: **Auto**, **QPSK**, **16 QAM**, or **64 QAM**.
 - To select the downlink zone, press the **DL Zone** soft key and then select the permutation zone option: **Auto**, **PUSC** for partial usage of subcarrier channels, **FUSC** for full usage of subcarrier channels, or **AMC2X3** for adaptive modulation and coding.

NOTE

The permutation zone, which is a number of contiguous OFDMA symbols in downlink that use the same permutation. The DL subframe may contain more than one permutation zone. The maximum number of DL zone is 8 in one DL subframe.

- To set the delay, complete the following steps:
 - a. Press the **Delay** soft key to set the amount of delay in μs .
 - b. Enter a value by using the numeric keys. You can also use the rotary knob.
 - c. Press the **μs** soft key.

NOTE

The Delay setting is used only when there is a time offset in the signals to be measured.

Measurement example

Figure 225 EVM vs. symbol measurement with Mobile WiMAX signal analyzer



NOTE

You can use the **LIMIT** hot key to analyze your measurements with the user-definable limit and Pass/Fail indication. See “Setting limit for modulation tests” on page 450 for more information. The Spectral Flatness and Frequency Error are not used in the EVM vs. Subcarrier mode.

Setting limit for modulation tests

Procedure

1. Press the **LIMIT** hot key.
2. Press the **Modulation Test Limits** soft key to set the limits.
3. Select the test item(s) and set the limit(s) depending on your selected measurement mode:

To set the limit for	Select	Set
Spectral flatness	Spectral Flatness	On/Off
Frequency error	Frequency Error	High Limit Low Limit
RMS for RCE	RCE RMS	High Limit
Peak for RCE	RCE Peak	High Limit
RMS for error vector magnitude	EVM RMS	High Limit
Peak for error vector magnitude	EVM Peak	High Limit

4. *Optional.* You can enable alarm sound that goes off if the measurement falls outside of the limit. Toggle the **Beep** soft key between **On** and **Off** to enable or disable the beep sound.
5. *Optional.* Go to **SAVE/LOAD > Save**, and then select **Limit** to save the limit settings. See “Using save” on page 31 for more information.

Performing auto measurements

The Auto Measure function of the JD780A series allows a complete signal profiling covering RF characterization and modulation quality parameters of up to 10 different carriers, particularly useful on an overlay architecture where base stations are transmitting in different frequencies.

The Auto Measure can be easily executed either by selecting a menu in the instrument or by running a programmed scenario in the PC-based application so that the instrument automatically configure and perform tests on every aspect of all the carriers.

Setting limit

You can set test limits for test item(s) in the auto measurement.

Procedure

1. Press the **LIMIT** hot key.
 2. Press the **RF Test Limits** soft key, and then enable test limits as desired.
 3. Press the **PvsT Test Limits** soft key, and then enable test limits as desired.
 4. Press the **Modulation Test Limits** soft key, and then enable test limits as desired.
 5. *Optional.* You can enable alarm sound that goes off if the measurement falls outside of the limit. Toggle the **Beep** soft key between **On** and **Off** to enable or disable the beep sound.
 6. *Optional.* Go to **SAVE/LOAD > Save**, and then select **Limit** to save the limit settings. See "Using save" on page 31 for more information.
-

Setting measure setup

After configuring test parameters as described in the "Configuring test parameters" on page 427, you can continue your measurement. The measurement settings can be saved and recalled as a file. You can also use JDViewer, PC application software to configure a measure setup, save as a file, and load the file on to the instrument.

Procedure

1. Press the **MEASURE SETUP** hot key.
 2. Toggle the **Configuration** soft key and select the configuration option:
 - **Current**: to let the instrument use current frequency (single carrier) and determine pass or fail based on the instrument's limit settings in Auto Measure.
 - **Scenario**: to run a test with a programmed scenario in JDViewer. The Scenario menu becomes activated.
 3. To load a scenario, press the **Scenario** soft key, and then select a scenario file to load.
 4. Toggle the **Test Time** soft key and select the test time option:
 - **Now**: to let the instrument run a test only once.
 - **Schedule**: to let the instrument repeat tests as defined in the Set Timing. The Set Timing menu becomes activated.
 5. To define a schedule for an auto measurement, complete the following steps:
 - a. Press the **Set Timing** soft key.
 - b. Press the **Start Time (HH:MM)** soft key.
-

-
- c. Enter the time in the HH:MM format, and then press the **Enter** soft key.
 - d. Press the **Stop Time (HH:MM)** soft key.
 - e. Enter the time in the HH:MM format, and then press the **Enter** soft key.
 - f. Press the **Time Interval** soft key.
 - g. Enter the amount of time in minutes, and then press the **Enter** soft key.
7. Press the **Settings** soft key, and then set the following:
 - a. Press the **Start Symbol** soft key.
 - b. Enter a value by using the numeric keys, and then press the **Enter** soft key.
 - c. Press the **Stop Symbol** soft key.
 - d. Enter a value by using the numeric keys, and then press the **Enter** soft key.
 - e. Toggle the **External Offset** soft key and select **On** or **Off**.
 - f. Enter a value by using the numeric keys, and then press the **dB** soft key.
 8. To save your settings and results, go to **SAVE/LOAD > Save** and then perform functions as you desire. See "Using save" on page 31 for more information.
 9. Press the **Run Test** soft key to start to run a test.
The Auto Measure Results window appears at the end of the test.
 10. To stop running the test, press the **Abort** soft key.
 11. To change the view on the screen during the test, press the **Display** and then select the view option from the following choices:
 - **Screen:** You can view each measurement screen as the test progresses.
 - **Results:** You can view a measurement result table as the test progresses.
 - **Settings:** You can view a measurement setting table as the test progresses.
-

Setting display

After completion of the auto measurement, the screen menu changes to Trace/Display so that you can view the results in different forms.

Procedure

1. Toggle the **Display** soft key and select the display option:
 - **Result:** to view the result table.
The Display Result menu becomes activated.
 - **Settings:** to view the measurement settings for the auto measurement.
 2. Toggle the **Display Result** soft key and select the display result option:
 - **Full:** to view detailed measurement readings with the pass/fail indication.
 - **Quick:** to view only the Pass/Fail results.
 3. To view the measurement results for a different carrier, press the **View Carrier** soft key and then select the carrier number to view.
-

Performing power statistics CCDF measurements

The Power Statistics Complementary Cumulative Distribution Function (CCDF) measurement characterizes the power statistics of the input signal. It provides PAR (Peak to Average power Ratio) versus different probabilities.

Setting measure setup

After configuring test parameters as described in the “Configuring test parameters” on page 427, you can continue your measurement. The measurement settings can be saved and recalled as a file. You can also use JDViewer, PC application software to configure a measure setup, save as a file, and load the file on to the instrument.

Procedure

1. Press the **MEASURE SETUP** hot key.
 2. Press the **CCDF Length** soft key to set the length of the CCDF.
 3. Enter a value between 1 and 100 by using the numeric keys. You can also use the rotary knob.
 4. Press the **Enter** soft key.
-

Measurement example

Figure 226 CCDF measurement with Mobile WiMAX signal analyzer



Conducting Mobile WiMAX OTA measurements

This Over The Air (OTA) measurement has preamble scanner, multipath profile, and preamble power trend screens. Preamble scanner displays six preambles and relative powers to inform neighbor cells existence. The multipath profile graph helps the user to determine testing area's RF environmental condition. The preamble power trend shows power variations of selected preamble over time along with relative power trend for strongest preamble.

Preamble scanner

The OTA Preamble Scanner displays the six strongest preambles to inform neighbor cells existence of testing area. Preamble Index, Relative Power, Cell ID, and Sector ID are listed in for each preamble signal with Time Offset in us. Positioning information, latitude, and longitude will be displayed if a GPS antenna is supplied and locked to the GPS satellites on the bottom of the screen.

Setting measure setup

After configuring test parameters as described in the “Configuring test parameters” on page 427, you can continue your measurement.

Procedure

1. Press the **MEASURE SETUP** hot key.
2. Press the **System Config** soft key, and then do the following:
 - a. Press the **Bandwidth** soft key, and then select the nominal channel bandwidth to be measured from the following choices:
 - **7 MHz (8/7)**: Sets the channel bandwidth to 7 MHz with sampling factor 8/7. In conjunction with nominal channel bandwidth
 - **8.75 MHz (8/7)**: Sets the channel bandwidth to 8.75 MHz with sampling factor 8/7
 - **10 MHz (28/25)**: Sets the channel bandwidth to 10 MHz with sampling factor 28/25
 - b. Toggle the **Frame Length** soft key and select **5 ms** or **10 ms**.
 - c. Press the **TTG (RTG)** soft key to set the transmit/receive transition gap between the last sample of the downlink burst and the first sample of the subsequent uplink burst.
 - d. Enter a value by using the numeric keys, and then press the **Enter** soft key.
 - e. Press the **CP Ratio** soft key, and then select the cyclic prefix ratio option: **1/4**, **1/8**, **1/16**, or **1/32**.
 - f. Press the **DL Symbols** soft key to set the number of downlink symbols.
 - g. Enter a value by using the numeric keys, and then press the **Enter** soft key.
 - h. Press the **UL Symbols** soft key to set the number of uplink symbols.
 - i. Enter a value by using the numeric keys, and then press the **Enter** soft key.
3. *Optional.* Press the **Miscellaneous** soft key, and then do the following as needed:
 - To set the delay, complete the following steps:
 - a. Press the **Delay** soft key to set the amount of delay in μ s.
 - b. Enter a value by using the numeric keys. You can also use the rotary knob.
 - c. Press the **μ s** soft key.

NOTE

The Delay setting is used only when there is a time offset in the signals to be measured.

4. *Optional.* Go to **SAVE/LOAD > Save**, and then select the save option from the choices available for your measurement mode. See “Using save” on page 31 for more information.
-

Measurement example

Figure 227 Preamble scanner measurement with Mobile WiMAX OTA signal analyzer



Multipath profile

The Multipath Profile enables the user to determine RF environmental conditions of testing area. It indicates the multipath power with time delay in us up to six.

The multipath profile is the result of portions of the original broadcast signal arriving at the receiving antenna out of phase. This can be caused by the signal being reflected off objects such as buildings, or being refracted through the atmosphere differently from the main signal.

Setting measure setup

After configuring test parameters as described in the “Configuring test parameters” on page 427, you can continue your measurement.

Procedure

1. Press the **MEASURE SETUP** hot key.
2. Press the **System Config** soft key, and then do the following:
 - a. Press the **Bandwidth** soft key, and then select the nominal channel bandwidth to be measured from the following choices:
 - **7 MHz (8/7)**: Sets the channel bandwidth to 7 MHz with sampling factor 8/7. In conjunction with nominal channel bandwidth
 - **8.75 MHz (8/7)**: Sets the channel bandwidth to 8.75 MHz with sampling factor 8/7
 - **10 MHz (28/25)**: Sets the channel bandwidth to 10 MHz with sampling factor 28/25
 - b. Toggle the **Frame Length** soft key and select **5 ms** or **10 ms**.
 - c. Press the **TTG (RTG)** soft key to set the transmit/receive transition gap between the last sample of the downlink burst and the first sample of the subsequent uplink burst.
 - d. Enter a value by using the numeric keys, and then press the **Enter** soft key.
 - e. Press the **CP Ratio** soft key, and then select the cyclic prefix ratio option: **1/4**, **1/8**, **1/16**, or **1/32**.

- f. Press the **DL Symbols** soft key to set the number of downlink symbols.
 - g. Enter a value by using the numeric keys, and then press the **Enter** soft key.
 - h. Press the **UL Symbols** soft key to set the number of uplink symbols.
 - i. Enter a value by using the numeric keys, and then press the **Enter** soft key.
3. *Optional.* Press the **Miscellaneous** soft key, and then do the following as needed:
- To set the delay, complete the following steps:
 - a. Press the **Delay** soft key to set the amount of delay in μs .
 - b. Enter a value by using the numeric keys. You can also use the rotary knob.
 - c. Press the **μs** soft key.

NOTE

The Delay setting is used only when there is a time offset in the signals to be measured.

4. *Optional.* Go to **SAVE/LOAD > Save**, and then select the save option from the choices available for your measurement mode. See “Using save” on page 31 for more information.

Measurement example

Figure 228 Multipath profile measurement with Mobile WiMAX OTA signal analyzer



Preamble power trend

The Preamble Power Trend shows power variations of a strongest preamble signal over time along with the relative power trend compare to total preamble power. Searching preamble index can be set auto to detect strongest or manual to search specific preamble. Positioning information, latitude, and longitude will be displayed if a GPS antenna is supplied and locked to the GPS satellites on the bottom of the screen.

Setting measure setup

After configuring test parameters as described in the “Configuring test parameters” on page 427, you can continue your measurement.

Procedure

1. Press the **MEASURE SETUP** hot key.
2. Press the **System Config** soft key, and then do the following:
 - a. Press the **Bandwidth** soft key, and then select the nominal channel bandwidth to be measured from the following choices:
 - **7 MHz (8/7)**: Sets the channel bandwidth to 7 MHz with sampling factor 8/7. In conjunction with nominal channel bandwidth
 - **8.75 MHz (8/7)**: Sets the channel bandwidth to 8.75 MHz with sampling factor 8/7
 - **10 MHz (28/25)**: Sets the channel bandwidth to 10 MHz with sampling factor 28/25
 - b. Toggle the **Frame Length** soft key and select **5 ms** or **10 ms**.
 - c. Press the **TTG (RTG)** soft key to set the transmit/receive transition gap between the last sample of the downlink burst and the first sample of the subsequent uplink burst.
 - d. Enter a value by using the numeric keys, and then press the **Enter** soft key.
 - e. Press the **CP Ratio** soft key, and then select the cyclic prefix ratio option: **1/4**, **1/8**, **1/16**, or **1/32**.
 - f. Press the **DL Symbols** soft key to set the number of downlink symbols.
 - g. Enter a value by using the numeric keys, and then press the **Enter** soft key.
 - h. Press the **UL Symbols** soft key to set the number of uplink symbols.
 - i. Enter a value by using the numeric keys, and then press the **Enter** soft key.
3. Toggle the **Preamble Index** soft key and select the preamble search method: **Auto** or **Manual**.
4. *Optional.* Press the **Miscellaneous** soft key, and then do the following as needed:
 - To set the delay, complete the following steps:
 - a. Press the **Delay** soft key to set the amount of delay in μ s.
 - b. Enter a value by using the numeric keys. You can also use the rotary knob.
 - c. Press the **μ s** soft key.

NOTE

The Delay setting is used only when there is a time offset in the signals to be measured.

5. *Optional.* Go to **SAVE/LOAD > Save**, and then select the save option from the choices available for your measurement mode. See “Using save” on page 31 for more information.
-

Measurement example

Figure 229 Preamble power trend with Mobile WiMAX OTA signal analyzer



Route map

The JD780A Series provides indoor and outdoor mapping function that allows a user to collect data of points in an indoor or outdoor environment and track the received signals and coverage of RF transmitters plotting real time directly on top of a loaded floor plan or a map.

Setting measure setup

Procedure

1. If required, connect a GPS receiver to your JD780A series for outdoor mapping. Indoor mapping does not necessarily need a GPS antenna.
2. Configure test parameters as described in the “Configuring test parameters” on page 427.
3. To load your map file, complete the following steps:
 - a. Plug in your USB drive that has a floor map or .mcf file type created in JDMapCreator.

NOTE

The JDMapCreator converts and resizes any scanned floor plan or layout to fit onto your instrument’s display. You must save your map files (.mcf) into the “SavedMap” folder of your USB drive so that you can load them onto your instrument.

- b. Press **SAVE/LOAD** hot key, and then select **Load > Load Map**. See “Using load” on page 34 for more information.
4. Press the **MEASURE SETUP** hot key.
5. Press the **Plot Point** soft key, and then select the plot point option from the following choices:
 - To collect data/plot points automatically as you move around in a vehicle or outside, press the **GPS** soft key and then toggle the **Screen Mode** soft key between **Map** and **Full**.

NOTE

With the **Map** setting, you can view only the collected points that can be seen within the boundary of the loaded map. If a point is off the map, the instrument displays an arrow to indicate the direction of the current location on the map and the distance from the center

to the location at the top of the screen.

With the **Full** setting, you can view all the collected points of the route without the loaded map.

- To collect data/plot points manually without a GPS antenna in an indoor environment, press the **Position** soft key.
6. Toggle the **Plot** soft key and select **Start** to start plotting.
 7. Touch directly on the screen or press the **ENTER** hard key to collect data and plot points on the loaded map for the **Position** setting.

NOTE

For the **Position** setting, you can change the direction of the route with the arrow keys and the distance with the rotary knob.

8. Toggle the **Plot** soft key and select **Stop** to stop plotting.
9. Press the **SAVE/LOAD** hot key to save the result.
See "Using save" on page 31 for more information.

NOTE

The instrument does not automatically save the collected data. It is recommended that you save the result. Otherwise, you will lose all the collected data.

Setting limit for route map

You can set the thresholds for each test item.

Procedure

1. Press the **LIMIT** hot key.
 2. Press the **Excellent** soft key to set its threshold.
 3. Enter a value, and then press the **Enter** soft key. You can also use the rotary knob.
 4. Press the **Very Good** soft key to set its threshold.
 5. Enter a value, and then press the **Enter** soft key. You can also use the rotary knob.
 6. Press the **Good** soft key to set its threshold.
 7. Enter a value, and then press the **Enter** soft key. You can also use the rotary knob.
 8. Press the **Fair** soft key to set its threshold.
 9. Enter a value, and then press the **Enter** soft key. You can also use the rotary knob.
 10. Press the **Poor** soft key to set its threshold.
 11. Enter a value, and then press the **Enter** soft key. You can also use the rotary knob.
 12. *Optional.* Go to **SAVE/LOAD > Save**, and then select **Limit** to save the limit settings.
See "Using save" on page 31 for more information.
-

Measurement example

Figure 230 Route map measurement with Mobile WiMAX OTA signal analyzer

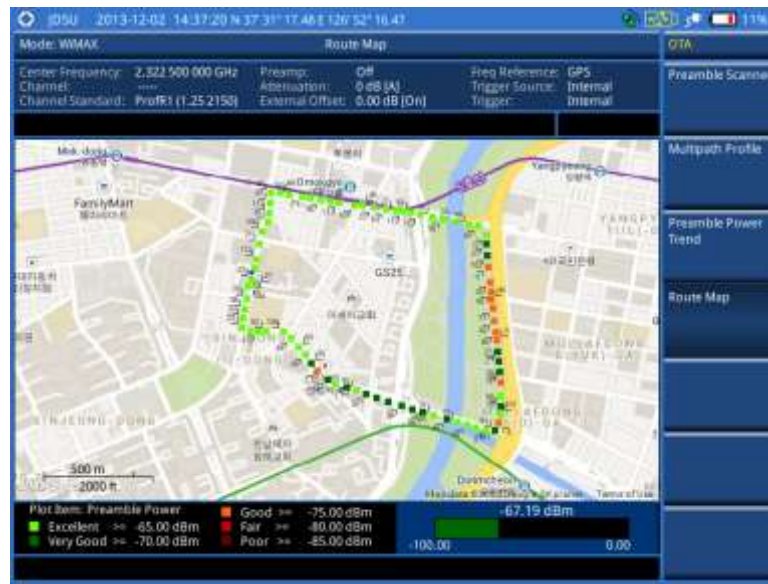

Using Cable and Antenna Analyzer

This chapter provides instructions for using the Cable and Antenna Analyzer function, which is available for the JD785A Base Station Analyzer and the JD786A RF Analyzer. Topics discussed in this chapter are as follows:

■ Introduction	462
■ Display overview	462
■ Selecting measurement mode	463
■ Configuring test parameters	463
■ Performing calibration	465
■ Connecting a cable	469
■ Performing reflection measurements	471
■ Performing DTF measurements	473
■ Performing reflection-DTF measurements	476
■ Performing cable loss (1 port) measurements	477
■ Performing 1-port phase measurements	479
■ Performing Smith chart measurements	480
■ Performing 2-port vector measurements	481
■ Performing 2-port scalar measurements	483
■ Analyzing measurements	484

Introduction

The Cable and Antenna Analyzer is a diagnostic tool needed to accurately detect operational problems by performing cable and antenna measurements to verify the base station's infrastructure, including feed lines, connectors, antennas, cables, jumpers, amplifiers, and filters. The JD785A Base Station Analyzer and the JD786A RF Analyzer have all of the measurement functions necessary to verify cable and antenna systems from Voltage Standing Wave Ratio (VSWR) to power measurements. In addition, the JD785A and the JD786A make distance-to-fault measurements to pinpoint a faulty location accurately.

To get maximum power into a load it is required that the load impedance match the generator impedance. Any difference in impedance or mismatching would not produce maximum power transfer. An impedance mismatch at the antenna system produces a reflective 'traveling wave', which goes in the opposite direction from the incident wave. As the two traveling waves cross each other in opposite direction, it is produce an interference pattern called a "standing wave". VSWR is the ratio between the power sent forward to the cable and/or antenna and the amount of power that is reflected back to the transmitter.

Some of the consequences of having a high VSWR condition in cellular services include dropped calls, poor reception, and an overall unacceptable performance in the cell (or section of cell) covered by the base station antenna. Therefore, the VSWR of the antenna system including the feed line is one of the most critical factors in the service and maintenance of the RF transmitter systems.

This Cable and Antenna Analyzer function performs following measurements:

- Reflection: VSWR and Return Loss
- Distance to Fault (DTF): VSWR and Return Loss
- Reflection-DTF (dual measurement)
- 2 Port Measurements: Vector and Scalar (Optional)
- Cable Loss (1 Port)
- 1 Port Phase
- Smith Chart

Display overview

Figure 231 provides descriptions for each segment of the measurement screen.

Figure 231 Reflection measurement screen



Selecting measurement mode

Procedure

1. Press the **MODE** hard key.
2. Press the **Cable & Antenna Analyzer** soft key. The **Reflection (VSWR)** mode is selected by default.
3. To change the mode, press the **MEASURE** hot key and then select the measurement mode:
 - Reflection (Return Loss)
 - DTF (VSWR)
 - DTF (Return Loss)
 - Reflection-DTF
 - Cable Loss (1 Port)
 - 1 Port Phase, Smith Chart
 - 2 Port Measurement (Vector/Scalar)

Configuring test parameters

Setting frequency

You can set frequencies manually using the Start Frequency/Stop Frequency or Center Frequency/Span. You can also select from the band list stored in the instrument. It is recommended to set the frequency to a value that covers the normal range of the measurement with enough margins.

Procedure

To set the start and stop frequencies:

1. Press the **FREQ/DIST** hard key.
2. Press the **Start Frequency** soft key.
3. Enter a value by using the numeric keys. You can also use the rotary knob or the arrow keys.
4. Select the unit: **GHz**, **MHz**, **kHz**, or **Hz**.
5. Press the **Stop Frequency** soft key.
6. Enter a value by using the numeric keys. You can also use the rotary knob or the arrow keys.
7. Select the unit: **GHz**, **MHz**, **kHz**, or **Hz**.

To set the center frequency and span:

1. Press the **FREQ/DIST** hard key.
2. Press the **Center Frequency** soft key.
3. Enter a value by using the numeric keys. You can also use the rotary knob or the arrow keys.
4. Select the unit: **GHz**, **MHz**, **kHz**, or **Hz**.
5. Press the **Span** soft key.
6. Enter a value by using the numeric keys. You can also use the rotary knob or the arrow keys.
7. Select the unit: **GHz**, **MHz**, **kHz**, or **Hz**.

To select the band from the band list:

1. Press the **FREQ/DIST** hard key.
 2. Press the **Band List** soft key, and then select **Standard Band** or **Custom Band**.
The band list window appears.
 3. Select a frequency band from the list, and then press the **Select** soft key.
The start and stop frequency information on the screen changes according to your choice.
-

Setting distance

In the DTF measurement mode, you need to set the start and stop distances. The maximum measurable distance is displayed on the left side of the screen depending on the frequency setting. You can set any distance within the maximum measurable distance. Optimum resolution is achieved when the user setting distance is the same as the maximum measurable distance

Procedure

1. Press the **FREQ/DIST** hard key.
 2. Press the **Start Distance** soft key.
 3. Enter a value by using the numeric keys. You can also use the rotary knob or the arrow keys.
 4. Select the **Enter** soft key.
 5. Press the **Stop Frequency** soft key.
 6. Enter a value by using the numeric keys. You can also use the rotary knob or the arrow keys.
 7. Select the **Enter** soft key.
-

Adjusting scale

You can adjust the Y-axis scale to optimize the display of measurement trace(s). Adjusting scale does not affect the calibration state.

Procedure

1. Press the **AMP/SCALE** hard key.
 2. Do one of the following choices:
 - Press the **Auto Scale** to optimize the display of the measured trace by letting the instrument set the minimum and maximum values for the Y-axis automatically. Each time this key is pressed, the top and bottom scales are set to the minimum and maximum values with margin on the Y-axis of the chart.
 - Press the **Full Scale** to restore the instrument's default amplitude range for the Y-scale automatically.
 - To set the minimum and maximum values for the Y-axis manually, complete the following steps:
 - a. Press the **Maximum (Top)** soft key.
 - b. Enter a value by using the numeric keys.
 - c. Press the **Enter** soft key.
 - d. Press the **Minimum (Top)** soft key.
 - e. Enter a value by using the numeric keys.
 - f. Press the **Enter** soft key.
-

NOTE

This setting is not used in the Smith Chart measurement mode.

Setting sweep mode

The default settings of the sweep mode are **Continue** and **Normal** to sweep continuously at a normal speed for most on-going measurements. If you want to hold the measurement or get a single sweep, you can change the sweep mode.

Procedure

To select the single sweep mode:

1. Press the **SWEEP** hot key.
2. Toggle the **Sweep Mode** soft key and select **Single**. You can also use the **HOLD** hot key. The letter **HOLD** in red appears and the sweeping is paused.
3. *Optional.* Press the **Sweep Once** soft key to get a new measurement.

To return to the continuous sweep mode:

1. Toggle the **Sweep Mode** soft key and select **Continue**. You can also use the **HOLD** hot key. The letter **HOLD** in red disappears and the sweeping resumes.
-

Performing calibration

To get reliable and accurate measurement results, you must perform a calibration on your instrument after setting frequencies and prior to making a measurement. You need to have the following ready:

- Calibration accessories (optional).
- Calibration Kit: Includes one 50-ohm load, one open standard, and one short standard.
- Test Cable: Use a phase stable cable for reliable and consistent measurement results.

1-port calibration

Measurements that need the 1-port calibration are in the Reflection, DTF, Cable Loss, 1 Port Phase, or Smith Chart mode.

Figure 232 illustrates the connection method when a port extension cable is used for calibration. To compensate errors caused by a port extension cable or adapters, perform an Open-Short-Load calibration including the port extension cable.

Figure 232 Connection for 1-port calibration



NOTE

Do not use an unnecessary extension cable or adapter in order to prevent a measurement error.

Bending or moving the extension cable while making a measurement may cause errors in the measurement.

NOTE

If O-S-L calibration is done at the end of the port extension cable for DTF measurement, the length of the port extension cable is compensated automatically and is not included in the distance to the point of discontinuity.

O-S-L calibration

The Open-Short-Load calibration must be performed after setting frequency and connecting a test cable. When using an extension cable connected to the Cable and Antenna Analyzer Reflection/RF Out port, the calibration kit must be connected to the other end of the extension cable.

Procedure

1. Press the **MEASURE SETUP** hot key.
2. Press the **Calibrate** soft key.
The on-screen instruction for the calibration appears.
3. Connect the **OPEN** connector of the CAL Kit directly to the **Cable and Antenna Analyzer Reflection/RF Out** port or at the end of the connected extension cable.

4. Press the **Continue** soft key to start calibration.
The calibration progress bar appears.
5. Connect the **SHORT** connector of the CAL Kit directly to the **Cable and Antenna Analyzer Reflection/RF Out** port or at the end of the connected extension cable.
6. Press the **Continue** soft key to continue calibration.
The calibration progress bar appears.
7. Connect the **LOAD** connector of the CAL Kit directly to the **Cable and Antenna Analyzer Reflection/RF Out** port or at the end of the connected extension cable.
8. Press the **Continue** soft key to continue calibration.
The calibration progress bar appears.
After completion, the calibration status on the screen changes to **CAL ON**.

Quick calibration

The Quick Calibration is useful when you want to measure only cable length in DTF measurements.

Procedure

1. Press the **MEASURE SETUP** hot key.
2. Press the **Calibrate** soft key.
3. Connect the **OPEN** connector of the CAL Kit directly to the **Cable and Antenna Analyzer Reflection/RF Out** port or at the end of the connected extension cable.
4. Press the **Quick Cal.** soft key to turn the quick calibration off.
The calibration status on the screen changes back to the previous state.

2-port calibration

You must perform 2-port calibration for 2-port measurements before making a measurement.

Vector measurement

Figure 233 illustrates the connection diagram for calibration in Vector measurements.

Figure 233 Connection for 2-port calibration in vector measurement

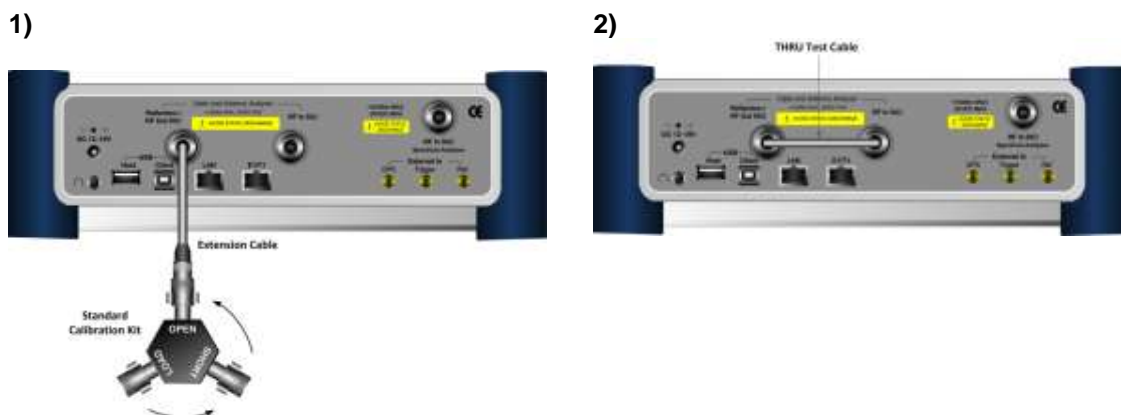

Procedure

1. Press the **MEASURE SETUP** hot key.
 2. Press the **Calibrate** soft key.
The on-screen instruction for the calibration appears.
 3. Connect the **OPEN** connector of the CAL Kit directly to the **Cable and Antenna Analyzer Reflection/RF Out** port or at the end of the connected test cable as illustrated in Figure 233-1).
 4. Press the **Continue** soft key to start calibration.
The calibration progress bar appears.
 5. Connect the **SHORT** connector of the CAL Kit directly to the **Cable and Antenna Analyzer Reflection/RF Out** port or at the end of the connected test cable.
 6. Press the **Continue** soft key to continue calibration.
The calibration progress bar appears.
 7. Connect the **LOAD** connector of the CAL Kit directly to the **Cable and Antenna Analyzer Reflection/RF Out** port or at the end of the connected test cable.
 8. Press the **Continue** soft key to continue calibration.
The calibration progress bar appears.
 9. Connect the **Reflection/RF Out** port and the **RF In** port for the Cable and Antenna Analyzer with the test cable (THRU cable) and the proper adapter as illustrated in Figure 233-2).
 10. Press the **Continue** soft key to continue calibration.
The calibration progress bar appears.
After completion, the calibration status on the screen changes to **CAL ON**.
-

Scalar measurement

Figure 234 illustrates the connection diagram for calibration in Scalar measurements.

Figure 234 Connection for 2-port calibration in scalar measurement

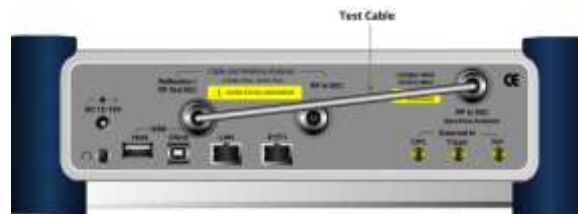

Procedure

1. Press the **MEASURE SETUP** hot key.
 2. Press the **Calibrate** soft key.
The on-screen instruction for the calibration appears.
 3. Connect the **Reflection/RF Out** port for the Cable and Antenna Analyzer and the **RF In** port for the Spectrum Analyzer with a test cable as illustrated in Figure 234.
 4. Press the **Continue** soft key to continue calibration.
The calibration progress bar appears.
After completion, the calibration status on the screen changes to **CAL ON**.
-

Calibration status indicators

The instrument displays calibration status that is an important indicator to get reliable and accurate measurement results from CAA testing. The calibration status includes **CAL ON**, **CAL ON (I)**, **CAL ON**

(Q), CAL OFF (T), and CAL OFF.

Table 22 Calibration status indicators

Indicator(s)	Description
CAL ON	Indicates that the O-S-L calibration is performed and the instrument is ready to make a measurement.
CAL ON (I)	Indicates that the frequency setting is changed within the frequency range registered for the O-S-L calibration and so the calibration is still valid. When the calibration status changes from CAL ON to CAL ON (I), re-calibration is not necessarily required.
CAL ON (Q)	Indicates that quick calibration (Quick Cal) is performed. It is useful only if cable length measurement is needed.
CAL OFF (T)	Indicates that the temperature registered during the calibration is changed by +/-10°C or greater. It is recommended that you perform a new O-S-L calibration to obtain accurate measurement results. When the temperature comes back within the registered range, the status may be changed to CAL ON.
CAL OFF	Indicates that the frequency setting is changed off the frequency range registered for the calibration. The calibration is no longer valid.

Connecting a cable

Connecting a cable for reflection, DTF, 1-port phase, and Smith Chart measurements

Procedure

1. Connect the one end of the port extension cable to the **Cable and Antenna Analyzer Reflection/RF Out** port of the instrument.
2. Connect the other end of the port extension cable to an antenna or feed line as illustrated in Figure 235.

Measurement result is displayed on the screen.

Figure 235 Connection for reflection measurement

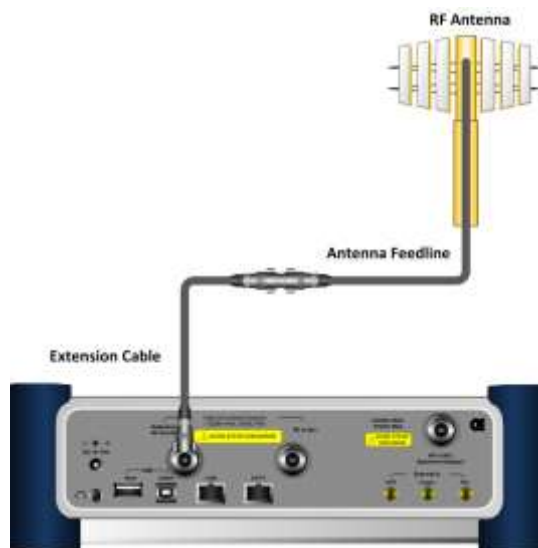

NOTE
 After calibration, do not change the connection of the port extension cable or the frequency setting. It may cause a measurement error.
 Changing any frequency settings will automatically turn the calibration status to OFF on the display screen, which requires re-calibration to proceed next measurement.

CAUTION

 The maximum input power for the **Cable and Antenna Analyzer Reflection/RF Out** port is +25 dBm. Do not connect this port directly to the output port of the system to prevent degraded performance or malfunctioning.

WARNING

 Do not attempt to connect the instrument to the antenna when there is a risk of lightning. Electric shock may cause malfunction of or damage to the instrument.

Connecting a cable for cable loss (1 port) measurements

Procedure

1. Connect the one end of the cable under test to the **Cable and Antenna Analyzer Reflection/RF Out** port of the instrument.
2. Connect the **SHORT** standard of the Cal Kit to the other end of the cable under test as illustrated in Figure 236.

Measurement result is displayed on the screen.

Figure 236 Connection for cable loss (1 port) measurement



Connecting a cable for 2-port vector measurements

Procedure

1. Connect the one end of the Thru test cable to the Cable and Antenna Analyzer Reflection/RF Out port of the instrument and the other end of the cable to DUT.
2. Connect the DUT to the **Cable and Antenna Analyzer RF In** port of the instrument as illustrated in Figure 237.

Measurement result is displayed on the screen.

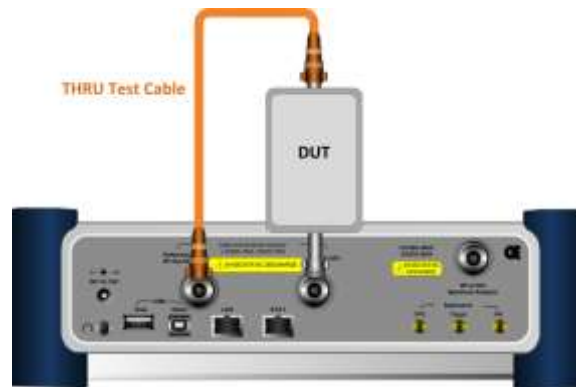
Figure 237 Connection for 2-port vector measurement**CAUTION**

The maximum input power for the **Cable and Antenna Analyzer RF In** port is +25 dBm. However, a proper level of input to the **Cable and Antenna Analyzer RF In** port is 0 dBm. When the input power is expected to be greater than 0 dBm, you must adjust the output power for the RF Out.

Connecting a cable for 2-port scalar measurements

Procedure

1. Connect the one end of the Thru test cable to the Cable and Antenna Analyzer Reflection/RF Out port of the instrument and the other end of the cable to DUT.
2. Connect the DUT to the **Spectrum Analyzer RF In** port of the instrument as illustrated in Figure 238. Measurement result is displayed on the screen.

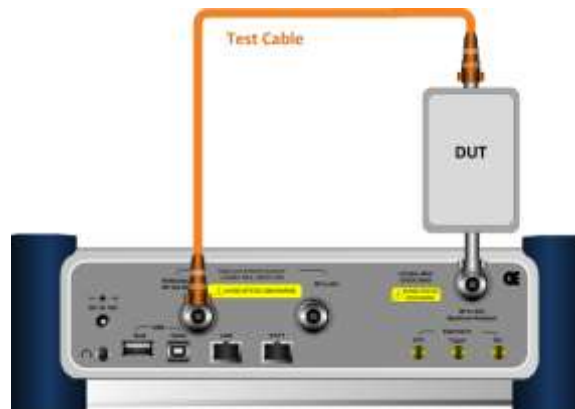
Figure 238 Connection for 2-port scalar measurement**CAUTION**

The maximum input power for the **Spectrum Analyzer RF In** port is +20 dBm.

Performing reflection measurements

The Reflection measurement can be used to characterize cable and antenna system to ensure transmission line impedance performance and signal reflection characteristics of cell-site across a

specific frequency range in voltage standing-wave ration (VSWR) or return loss.

Making a measurement

Procedure

1. Make a proper cable connection as described in “Connecting a cable for reflection, DTF, 1-port phase, and Smith Chart measurements” on page 469.
2. Press the **MEASURE SETUP** hot key.
3. Press the **Data Points** soft key to change the resolution of your measurement, and then select the data point option: **126**, **251**, **501**, **1001**, and **2001**. Changing the data point does not affect current calibration.

NOTE

The larger number you choose, the higher resolution you get and the longer the instrument takes to sweep and display results. Selecting the data point larger than what you need for a measurement will result in unnecessarily long sweep time. It is recommended that you select high resolution data points only for an instance of measuring wide frequency bands or requiring precise measurement data.

4. *Optional.* To turn the bias tee on, complete the following steps:
 - a. Toggle the **Bias Tee** soft key and select **On**.
 - b. Enter a value between 12 and 32 with 0.1 V step.
 - c. Enter the **V** soft key.

NOTE

The instrument’s built-in bias tee function (option 002) supplies 12-32 VDC bias to active devices through the **RF In** port, eliminating the need of an external power supply.

5. *Optional.* To select the output power, toggle the **Output Power** soft key between **0 dBm** and **-30 dBm**.

NOTE

When an amplifier’s reflection is measured, it is recommended that you change this output power level to -30 dBm and then re-calibrate. Changing to -30 dBm may result in reduced measurement dynamic range.

6. *Optional.* To turn the interference rejection on, toggle the **Interference Rej** soft key between **On** and **Off** to enable or disable the feature.

NOTE

It is recommended that you use this feature only when you suspect interfering signals in the area as turning this on slows down the measurement.

Measurement example

Figure 239 Reflection measurement in return loss scale



NOTE

You can use the **LIMIT** hot key to analyze your measurements with the user-definable limit and Pass/Fail indication. See “Setting limit for cable and antenna analyzer” on page 486 for more information.

NOTE

You can go to **MEASURE SETUP > Zone** to view your measurements in detail with the user-definable zoom zones. See “Setting zoom zones” on page 484 for more information.

Performing DTF measurements

The Distance-To-Fault (DTF) measurement can be used to accurately identify fault locations in the cell-site transmission (cable and feed line) system, indicating signal discontinuities in VSWR or return loss over distance in meter or foot. This measurement precisely pinpoints the location of such things as damaged or degraded antennas, connectors, amplifiers, filters, and duplexers.

Making a measurement

Procedure

1. Make a proper cable connection as described in “Connecting a cable for reflection, DTF, 1-port phase, and Smith Chart measurements” on page 469.
2. Press the **MEASURE SETUP** hot key.
3. Press the **Data Points** soft key to change the resolution of your measurement, and then select the data point option: **126**, **251**, **501**, **1001**, and **2001**. Changing the data point does not affect current calibration.

NOTE

The larger number you choose, the higher resolution you get and the longer the instrument takes to sweep and display results. Selecting the data point larger than what you need for a measurement will result in unnecessarily long sweep time. It is recommended that you select high resolution data points only for an instance of

measuring wide frequency bands or requiring precise measurement data.

4. Press the **DTF Settings** soft key, and then do the following:
 - To select a cable from the list, complete the following steps:
 - a. Press the **Cable List** soft key, and then select **Standard Cable** or **Custom Cable**. The cable list window appears.
 - b. Select a cable by using the rotary knob or the **Page Up/Page Down** soft keys.
 - c. Press the **Select** soft key.
 - d. *Optional.* In the standard cable list window, press the **Add to Custom** soft key to add the selected cable to the custom list.
 - To define a new cable, complete the following steps:
 - a. Press the **Prop Velocity** soft key to define the cable's relative propagation delay.
 - b. Enter a value by using the numeric keys. You can also use the rotary knob.
 - c. Press the **Enter** soft key.
 - d. Press the **Cable Loss** soft key to define the cable's cable loss.
 - e. Enter a value by using the numeric keys. You can also use the rotary knob.
 - f. Press the **Enter** soft key.

NOTE

The propagation velocity affects the calculation of the distance and the cable loss does the peak level of the discontinuity in a DTF measurement.

- Toggle the **Metrics** soft key and select the unit option for the X-axis: **Meter** or **Foot**.
 - Press the **Windowing** soft key, and then select the video filtering option: **Rectangular**, **Blackman**, **Nominal Side Lobe**, **Low Side Lobe**, or **Minimum Side Lobe**.
5. *Optional.* To turn the bias tee on, complete the following steps:
 - a. Toggle the **Bias Tee** soft key and select **On**.
 - b. Enter a value between 12 and 32 with 0.1 V step.
 - c. Enter the **V** soft key.

NOTE

The instrument's built-in bias tee function (option 002) supplies 12-32 VDC bias to active devices through the **RF In** port, eliminating the need of an external power supply.

6. *Optional.* To select the output power, toggle the **Output Power** soft key between **0 dBm** and **-30 dBm**.

NOTE

When an amplifier's reflection is measured, it is recommended that you change this output power level to -30 dBm and then re-calibrate. Changing to -30 dBm may result in reduced measurement dynamic range.

7. *Optional.* To turn the interference rejection on, toggle the **Interference Rej** soft key between **On** and **Off** to enable or disable the feature.

NOTE

It is recommended that you use this feature only when you suspect interfering signals in the area as turning this on slows down the measurement.

Measurement example

Figure 240 DTF measurement



NOTE

You can use the **LIMIT** hot key to analyze your measurements with the user-definable limit and Pass/Fail indication. See “Setting limit for cable and antenna analyzer” on page 486 for more information.

Figure 241 DTF measurement with the alternate sweep on



NOTE

You can go to **MEASURE SETUP > Alternate Sweep Settings** to scale down a specific sub-band. See “Setting alternate sweep” on page 485 for more information.

Performing reflection-DTF measurements

You can view two measurement results simultaneously on the screen as you configure each measurement setting.

Making a measurement

Procedure

1. Make a proper cable connection as described in “Connecting a cable for reflection, DTF, 1-port phase, and Smith Chart measurements” on page 469.
2. Press the **MEASURE SETUP** hot key.
3. Toggle the **Active Window** soft key between **Top** and **Bottom** and select the window to be active for setting.
4. Press the **Dual Config** soft key, and then select the dual configuration option:
 - To select the measurement mode for the top window, press the **Top** soft key, and then select **Reflection (VSWR)** or **Reflection (Return Loss)**.
 - To select the measurement mode for the bottom window, press the **Bottom** soft key, and then select **DTF (VSWR)** or **DTF (Return Loss)**.
 - To configure DTF settings for the bottom window, select **Bottom > DTF Settings**. See “Performing DTF measurements” on page 473 for more information.
 - To set the alternate sweep settings for the bottom window, select **Bottom > Alternate Sweep Settings**. See “Setting alternate sweep” on page 485 for more information.

NOTE

See “Performing reflection measurements” and “Performing DTF measurements” for more information on how to set other measurement setup parameters for the Reflection-DTF measurement.

Measurement example

Figure 242 Reflection-DTF dual measurement

1) Alternate sweep off:



2) Alternate sweep on:

**NOTE**

You can use the **LIMIT** hot key to analyze your measurements with the user-definable limit and Pass/Fail indication. See “Setting limit for cable and antenna analyzer” on page 486 for more information.

Performing cable loss (1 port) measurements

The Cable Loss (1 Port) measurement quantifies signal loss through a cable or other device over a defined frequency range by range by connecting one end of the cable to the instrument measurement port and terminating the other end of the cable with a short, or leaving it open altogether. This measurement can be particularly useful in measuring the loss of feed line connected to the antenna.

Making a measurement

Procedure

1. Make a proper cable connection as described in “Connecting a cable for cable loss (1 port) measurements” on page 470.
2. Press the **MEASURE SETUP** hot key.
3. Press the **Data Points** soft key to change the resolution of your measurement, and then select the data point option: **126**, **251**, **501**, **1001**, and **2001**. Changing the data point does not affect current calibration.

NOTE

The larger number you choose, the higher resolution you get and the longer the instrument takes to sweep and display results. Selecting the data point larger than what you need for a measurement will result in unnecessarily long sweep time. It is recommended that you select high resolution data points only for an instance of measuring wide frequency bands or requiring precise measurement data.

4. *Optional.* To turn the bias tee on, complete the following steps:
 - a. Toggle the **Bias Tee** soft key and select **On**.
 - b. Enter a value between 12 and 32 with 0.1 V step.
 - c. Enter the **V** soft key.

NOTE

The instrument's built-in bias tee function (option 002) supplies 12-32 VDC bias to active devices through the **RF In** port, eliminating the need of an external power supply.

NOTE

See "Performing reflection measurements" for more information on how to set other measurement setup parameters for the Cable Loss (1 Port) measurement.

Measurement example

Figure 243 Cable loss (1 port) measurement



NOTE

You can use the **LIMIT** hot key to analyze your measurements with the user-definable limit and Pass/Fail indication. See "Setting limit for cable and antenna analyzer" on page 486 for more information.

Figure 244 Cable loss (1 port) measurement with the zone enabled

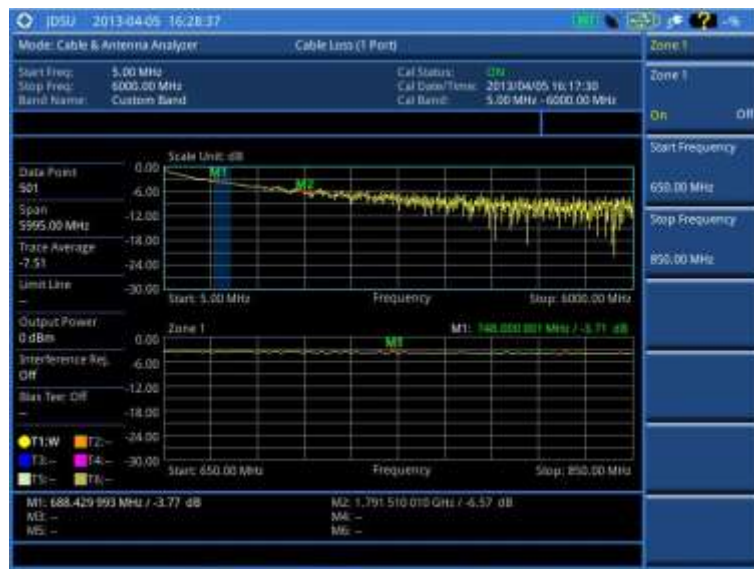

NOTE

You can go to **MEASURE SETUP > Zone** to view your measurements in detail with the user-definable zoom zones. See “Setting zoom zones” on page 484 for more information.

Performing 1-port phase measurements

The 1-port Phase measurement is used to measure S_{11} phase to tune antennas and to phase-match cables.

Making a measurement

Procedure

1. Make a proper cable connection as described in “Connecting a cable for reflection, DTF, 1-port phase, and Smith Chart measurements” on page 469.
2. Press the **MEASURE SETUP** hot key.
3. Press the **Data Points** soft key to change the resolution of your measurement, and then select the data point option: **126**, **251**, **501**, **1001**, and **2001**. Changing the data point does not affect current calibration.

NOTE

The larger number you choose, the higher resolution you get and the longer the instrument takes to sweep and display results. Selecting the data point larger than what you need for a measurement will result in unnecessarily long sweep time. It is recommended that you select high resolution data points only for an instance of measuring wide frequency bands or requiring precise measurement data.

4. *Optional.* To turn the bias tee on, complete the following steps:
 - a. Toggle the **Bias Tee** soft key and select **On**.
 - b. Enter a value between 12 and 32 with 0.1 V step.
 - c. Enter the **V** soft key.

NOTE

The instrument’s built-in bias tee function (option 002) supplies 12-32 VDC bias to active devices through the **RF In** port, eliminating the need of an external power supply.

NOTE

See “Performing reflection measurements” on page 471 for more information on how to set other measurement setup parameters for the Cable Loss (1 Port) measurement.

Measurement example

Figure 245 Cable loss (1 port) measurement



Figure 246 Cable loss (1 port) measurement with zoom

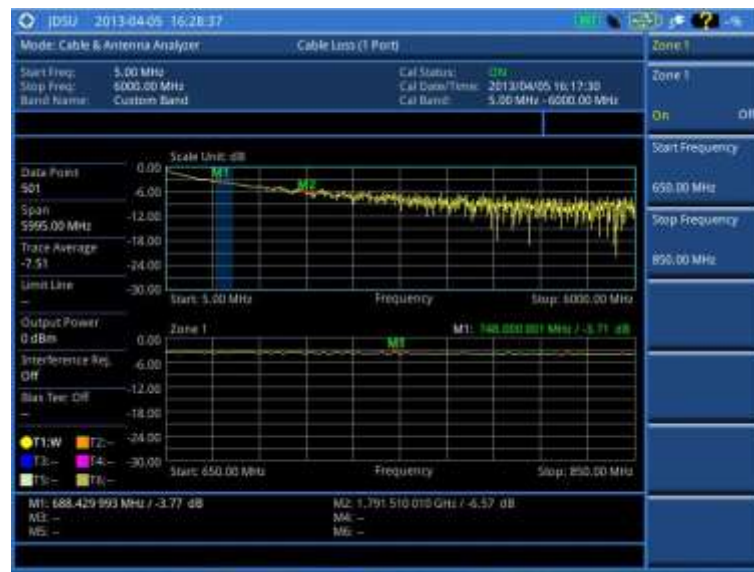

NOTE

You can use the **LIMIT** hot key to analyze your measurements with the user-definable limit and Pass/Fail indication. See “Setting limit for cable and antenna analyzer” on page 486 for more information.

NOTE

You can go to **MEASURE SETUP > Zone** to view your measurements in detail with the user-definable zoom zones. See “Setting zoom zones” on page 484 for more information.

Performing Smith chart measurements

The Smith Chart measurement is used to measure DUTs’ impedance and phase to properly tune RF

devices. Smith chart also displays impedance-matching characteristics in cable and antenna systems or filter and duplexer devices.

Making a measurement

Procedure

1. Make a proper cable connection as described in “Connecting a cable for reflection, DTF, 1-port phase, and Smith Chart measurements” on page 469.
2. Press the **MEASURE SETUP** hot key.
3. Press the **Data Points** soft key to change the resolution of your measurement, and then select the data point option: **126**, **251**, **501**, **1001**, and **2001**. Changing the data point does not affect current calibration.

NOTE

The larger number you choose, the higher resolution you get and the longer the instrument takes to sweep and display results. Selecting the data point larger than what you need for a measurement will result in unnecessarily long sweep time. It is recommended that you select high resolution data points only for an instance of measuring wide frequency bands or requiring precise measurement data.

4. *Optional.* To turn the bias tee on, complete the following steps:
 - a. Toggle the **Bias Tee** soft key and select **On**.
 - b. Enter a value between 12 and 32 with 0.1 V step.
 - c. Enter the **V** soft key.

NOTE

The instrument’s built-in bias tee function (option 002) supplies 12-32 VDC bias to active devices through the **RF In** port, eliminating the need of an external power supply.

NOTE

See “Performing reflection measurements” on page 471 for more information on how to set other measurement setup parameters for the Smith Chart measurement.

Performing 2-port vector measurements

The Vector measurement is used to perform faster and more accurate measurement with around 80 dB dynamic range. It also provides antenna isolation measurement. You can determine DUT’s S_{21} phase characteristic by selecting the measurement display type as Phase.

Making a measurement

Procedure

1. Make a proper cable connection as described in “Connecting a cable for 2-port vector measurements” on page 470.
2. Press the **MEASURE SETUP** hot key.
3. Press the **Data Points** soft key to change the resolution of your measurement, and then select the data point option: **126**, **251**, **501**, **1001**, and **2001**. Changing the data point does not affect current calibration.

NOTE

The larger number you choose, the higher resolution you get and the longer the

instrument takes to sweep and display results. Selecting the data point larger than what you need for a measurement will result in unnecessarily long sweep time. It is recommended that you select high resolution data points only for an instance of measuring wide frequency bands or requiring precise measurement data.

4. Toggle the **Display** soft key and select **Magnitude** to view measurements in dB or **Phase** in degree.
5. *Optional.* To turn the bias tee on, complete the following steps:
 - a. Toggle the **Bias Tee** soft key and select **On**.
 - b. Enter a value between 12 and 32 with 0.1 V step.
 - c. Enter the **V** soft key.

NOTE
The instrument's built-in bias tee function (option 002) supplies 12-32 VDC bias to active devices through the **RF In** port, eliminating the need of an external power supply.

6. *Optional.* To select the output power, toggle the **Output Power** soft key between **0 dBm** and **-30 dBm**.

NOTE
When an amplifier's reflection is measured, it is recommended that you change this output power level to -30 dBm and then re-calibrate. Changing to -30 dBm may result in reduced measurement dynamic range.

7. *Optional.* To set the number of measurements to be averaged, press the Average soft key and then adjust the number between one and five by using the rotary knob.
8. *Optional.* To turn the interference rejection on, toggle the **Interference Rej** soft key between **On** and **Off** to enable or disable the feature.

NOTE
It is recommended that you use this feature only when you suspect interfering signals in the area as turning this on slows down the measurement.

Measurement example

Figure 247 2-port vector measurement



Performing 2-port scalar measurements

The Scalar measurement enables full characterization of DUT with dynamics over 100 dB.

Making a measurement

Procedure

1. Make a proper cable connection as described in “Connecting a cable for 2-port scalar measurements” on page 471.
2. Press the **MEASURE SETUP** hot key.
3. Press the **Data Points** soft key to change the resolution of your measurement, and then select the data point option: **126**, **251**, **501**, **1001**, and **2001**. Changing the data point does not affect current calibration.

NOTE

The larger number you choose, the higher resolution you get and the longer the instrument takes to sweep and display results. Selecting the data point larger than what you need for a measurement will result in unnecessarily long sweep time. It is recommended that you select high resolution data points only for an instance of measuring wide frequency bands or requiring precise measurement data.

4. *Optional.* To select the output power, toggle the **Output Power** soft key between **0 dBm** and **-30 dBm**.

NOTE

When an amplifier’s reflection is measured, it is recommended that you change this output power level to -30 dBm and then re-calibrate. Changing to -30 dBm may result in reduced measurement dynamic range.

Measurement example

Figure 248 2-port scalar measurement



Analyzing measurements

Setting trace and display

You can display up to six traces on the measurement chart simultaneously.

Procedure

1. Press the **TRACE/DISPLAY** hard key.
2. Press the **Select Trace** soft key, and then select the trace number: **T1**, **T2**, **T3**, **T4**, **T5**, or **T6**. The legend shape of the selected trace changes from square to round to indicate that the trace is the active one now.
3. Toggle the **Trace View** soft key and select **On** to display the selected trace.
4. To clear, write or capture, or hide the trace(s), do one of the following:

To	Select	Trace Legend
Clear current data and display with new measurements	Clear Write	W
Capture the selected trace and compare traces	Capture	C
Load a saved trace	Load	L
Hide the selected trace	Trace View > Off	F
Remove all the traces and initialize the trace settings	Trace Clear All	

5. *Optional.* If you have at least two traces (T1 and T2), you can perform trace math:
 - a. Press the **Trace Math** soft key.
 - b. Press the **T1 – T2 -> T5** or **T2 – T1 -> T6** soft key.

NOTE

The trace to be loaded must be in the same measurement mode and has the same frequency setting as the current measurement.

Setting zoom zones

You can define up to three zoom-in zones so that you can view uplink and downlink frequencies in detail on a single measurement window for compliance verification.

Procedure

1. Press the **MEASURE SETUP** hot key.
 2. Press the **Zone** soft key.
 3. To zoom in a zone, complete the following steps:
 - a. Press the **Zoom** soft key, and then select the zone number to zoom in: **Zone 1**, **Zone 2**, or **Zone 3**.
 - b. Toggle the **Zoom** soft key and select **On**.
The zoom-in chart for the selected zone appears under the measurement result.
 4. To define a zone range, complete the following steps:
 - a. Press the **Zone [1|2|3]** soft key to select an active zone.
 - b. Toggle the **Zone [1|2|3]** soft key between **On** and **Off** to view or dismiss the active zone.
-

-
- c. Press the **Start Frequency** soft key.
 - d. Enter a value by using the numeric keys. You can also use the rotary knob.
 - e. Select the unit: **GHz**, **MHz**, **kHz**, or **Hz**.
 - f. Press the **Stop Frequency** soft key.
 - g. Enter a value by using the numeric keys. You can also use the rotary knob.
 - h. Select the unit: **GHz**, **MHz**, **kHz**, or **Hz**.
5. To clear all the zone settings, press the **Clear All** soft key.
-

Setting alternate sweep

You can use the Alternate Sweep in DTF measurements to scale down a specific sub-band without a need of an additional calibration.

Procedure

1. Press the **MEASURE SETUP** hot key.
 2. Press the Alternate Sweep Settings soft key.
 3. Toggle the **Alternate Sweep** soft key and select **On** or **Off** to enable or disable the alternate sweep feature.
 4. To set the start and stop distances for the alternate sweep, complete the following steps:
 - a. Press the **Start Distance** soft key.
 - b. Enter a value by using the numeric keys. You can also use the rotary knob or the arrow keys.
 - c. Select the **Enter** soft key.
 - d. Press the **Stop Frequency** soft key.
 - e. Enter a value by using the numeric keys. You can also use the rotary knob or the arrow keys.
 - f. Select the **Enter** soft key.
 5. To set the start and stop frequencies for the alternate sweep, complete the following steps:
 - a. Press the **Alternate Start Frequency** soft key.
 - b. Enter a value by using the numeric keys. You can also use the rotary knob or the arrow keys.
 - c. Select the unit: **GHz**, **MHz**, **kHz**, or **Hz**.
 - d. Press the **Alternate Stop Frequency** soft key.
 - e. Enter a value by using the numeric keys. You can also use the rotary knob or the arrow keys.
 - f. Select the unit: **GHz**, **MHz**, **kHz**, or **Hz**.
 6. To set the center and span frequencies for the alternate sweep, complete the following steps:
 - a. Press the **Alternate Center Frequency** soft key.
 - b. Enter a value by using the numeric keys. You can also use the rotary knob or the arrow keys.
 - c. Select the unit: **GHz**, **MHz**, **kHz**, or **Hz**.
 - d. Press the **Alternate Span Frequency** soft key.
 - e. Enter a value by using the numeric keys. You can also use the rotary knob or the arrow keys.
 - f. Select the unit: **GHz**, **MHz**, **kHz**, or **Hz**.
-

Setting limit for cable and antenna analyzer

Procedure

1. Press the **LIMIT** hot key.
 2. Press the **Multi Segment Line** soft key for Pass/Fail indication.
 3. Toggle the **Limit** soft key between **Upper** and **Lower** to select the one to be displayed.
 4. Set the number of segments for the selected upper or lower limit line. You can set up to 50 segments.
 - a. Press the **# of Line** soft key.
 - b. Enter a value between 1 and 50 by using the numeric keys.
 - c. Press the **Enter** soft key.
 5. Press the **Autoset** soft key to let the instrument set the limit for each segment and display the line.
 6. *Optional.* To move the limit line, complete the following steps:
 - a. Select **Limit Up/Down** or **Limit Left/Right**.
 - b. Turn the rotary knob to move the line as desired. You can also manually enter a value.
 7. *Optional.* To edit the segment properties, complete the following steps:
 - a. Press the **Edit Limit** soft key.
 - b. Press the **Move** soft key and then turn the rotary knob to select the segment to edit.
 - c. Select the menu option, from the following choices:
 - To hide the line for the selected segment, toggle the **Line** soft key and select **Off**.
 - To add a new point, press the **Add Point** soft key.
 - To delete the selected point, press the **Delete Point** soft key.
 - To change the position, press the **Frequency** or **Amplitude** soft key, and then turn the rotary knob to change the value as desired.
 8. *Optional.* Go to **SAVE/LOAD > Save**, and then select **Limit** to save the limit settings. See "Using save" on page 31 for more information.
-

Using E1 Analyzer

This chapter provides instructions for using the E1 Analyzer function (option 004). Topics discussed in this chapter are as follows:

- Introduction488
- Display overview488
- Connecting a cable489
- Monitoring transmission.....490
- Performing BERT testing491

Introduction

The European Conference of Postal and Telecommunications Administrations (CEPT) originally standardized the E-carrier system, which revised and improved the earlier American T-carrier technology, and this has now been adopted by the International Telecommunication Union Telecommunication Standardization Sector (ITU-T).

E1 is transmitted physically as 32 timeslots, but one is used for framing and typically one allocated for signaling call setup and tear down. Unlike Internet data services, E-carrier systems permanently allocate capacity for a voice call for its entire duration. This ensures high call quality because the transmission arrives with the same short delay (Latency) and capacity at all times.

This portable test instrument can be a useful tool to check the overall health of the transmission system and assist in locating the source of problems or defects.

The E1 Analyzer function provides following measurements:

- Monitoring
- BERT Testing (PCM31 only)

Display overview

Figure 249 provides descriptions for each segment of the measurement screen.

Figure 249 E1 analyzer screen



Connecting a cable

Out-of-service testing

Figure 250 Point-to-point connection

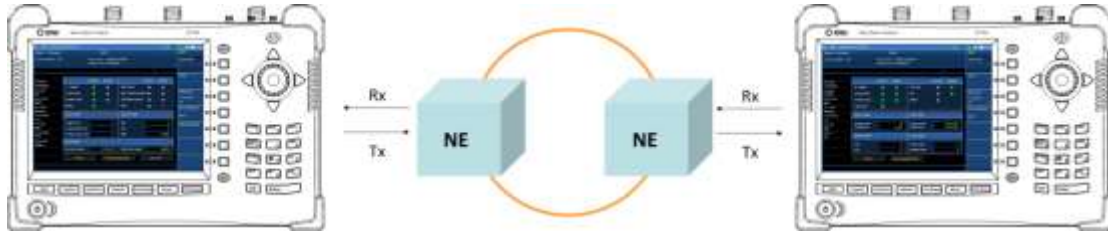

Figure 251 Loop-back connection

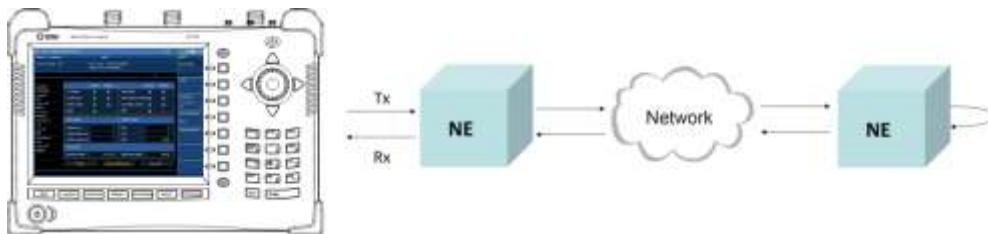
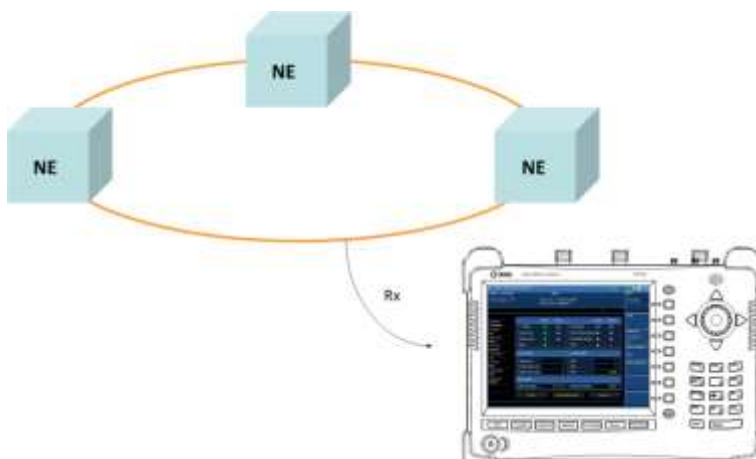

Figure 252 Error injection and measurement connection



In-service monitoring

Figure 253 In-service connection



Monitoring transmission

Making a test

Procedure

To select the measurement mode:

1. Press the **MODE** hard key.
2. Press the **E1/T1 Analyzer** soft key.
3. Select **E1 Analyzer > Monitoring**.

To configure measurement parameters:

1. Press the **MEASURE SETUP** hot key.
2. Press the **RX Mode** soft key, and then select the receiver input option from the following choices:
 - **Terminate**: Provides 120-ohm nominal input impedance, according to the framing and line code settings.
 - **Bridge**: Provides input impedance greater than one kilohm for in-service monitoring, bridging the receiver input across lines that are terminated elsewhere in the network.
 - **Monitor**: Provides 120-ohm nominal input impedance for the in-service monitoring of E1 lines.
3. Toggle the **Framing** soft key between **PCM30** and **PCM31** and select the framing type for your receiver setting:
 - **PCM30**: Timeslots from 1 to 15 correspond to channels from 1 to 15 and timeslots from 17 to 31 to channels from 16 to 30. Timeslot 16 is for the multi-frame alignment and Channel Associated Signaling (CAS).
 - **PCM31**: Timeslots from 1 to 31 correspond to channels from 1 to 31.

NOTE

If the framing type does not match with your receiver setting, a framing alarm occurs.

4. Toggle the **Line Code** soft key between **AMI** and **HDB3** and select the line code type to send an E1 signal:
 - **AMI**: It stands for Alternate Mark Inversion. A line code uses one three level signal to convey binary digits in which successive binary ones ("marks" or pulses) are of alternating polarity, either positive or negative, equal in amplitude. A binary zero ("space") is transmitted as no pulse or zero amplitude.
 - **HDB3**: It stands for High Density Bipolar order 3 encoding. It is a bipolar signaling technique (using both positive and negative pulses) based on the AMI. It extends AMI by inserting violation codes whenever there is a run of four or more zeros.

To start or stop monitoring:

1. Press the **MEASURE** hot key.
2. Press the **Monitoring** soft key, and then select the monitoring option as needed: **Start**, **Stop**, or **Clear**.

Optional. You can save event records automatically by using the **Save Result as CSV Format** soft key. See "Using save" on page 31 for more information.

Measurement example

Figure 254 E1 transmission monitoring for framing PCM30



NOTE

Bit Error is not supported for the framing type PCM30.

Performing BERT testing

There are three RX modes available for the BERT testing.

- **Terminate Mode:** The Terminate mode is used when you wish to send and receive an E1 signal. The instrument terminates the received signal with a low impedance termination, and requires that the circuit be disrupted for testing.
- **Bridge Mode:** The Bridge mode is similar to the monitor mode. However, in the Bridge mode, the instrument applies high impedance isolation resistors to the circuit under test. This isolation circuitry will protect the signal from any possible disruption. There is no need to plug into the TX jack of the test set while in the Bridge mode, and there is no need to specify a test pattern to be transmitted. However, the transmitter in the test set is sending the selected test pattern, framing, coding, and CRC.
- **Monitor Mode:** The Monitor (protected monitoring point) mode is used when a monitor access is to be made. The network element has isolated the MON signal from the live signal with high impedance resistors. It is useful that it protects the live signal from any possible disruptions caused by the testing process.

Making a test

Procedure

To select the measurement mode:

1. Press the **MODE** hard key.
2. Press the **E1/T1 Analyzer** soft key.

3. Select **E1 Analyzer > BERT**.

To configure measurement parameters:

1. Press the **MEASURE SETUP** hot key.
2. Press the **RX Mode** soft key, and then select the receiver input option from the following choices:
 - **Terminate:** Provides 120-ohm nominal input impedance, according to the framing and line code settings.
 - **Bridge:** Provides input impedance greater than one kilohm for in-service monitoring, bridging the receiver input across lines that are terminated elsewhere in the network.
 - **Monitor:** Provides 120-ohm nominal input impedance for the in-service monitoring of E1 lines.
3. Toggle the **Framing** soft key between **PCM30** and **PCM31** and select the framing type for your receiver setting:
 - **PCM30:** Timeslots from 1 to 15 correspond to channels from 1 to 15 and timeslots from 17 to 31 to channels from 16 to 30. Timeslot 16 is for the multi-frame alignment and Channel Associated Signaling (CAS).
 - **PCM31:** Timeslots from 1 to 31 correspond to channels from 1 to 31.

NOTE

If the framing type does not match with your receiver setting, a framing alarm occurs.

4. Toggle the **Line Code** soft key between **AMI** and **HDB3** and select the line code type to send an E1 signal:
 - **AMI:** It stands for Alternate Mark Inversion. A line code uses one three level signal to convey binary digits in which successive binary ones (“marks” or pulses) are of alternating polarity, either positive or negative, equal in amplitude. A binary zero (“space”) is transmitted as no pulse or zero amplitude.
 - **HDB3:** It stands for High Density Bipolar order 3 encoding. It is a bipolar signaling technique (using both positive and negative pulses) based on the AMI. It extends AMI by inserting violation codes whenever there is a run of four or more zeros.
5. Press the **Pattern** soft key, and then select the stress pattern option from the following choices:
 - **1-4:** A four-bit pattern that contains a single one, being used to test clock recovery.
 - **1-8:** An eight-bit pattern that contains a single one, being used to test clock recovery.
 - **All 1’S:** A pattern that causes line drivers to consume the maximum power.
 - **All 0’S:** A pattern that is often selected to verify HDB3 provisioning. Circuit will drop if optioned for AMI.
 - **Alternate:** A pattern that alternates between ones and zeroes.
6. Toggle the **TX Clock** soft key between **Internal** and **RX** and select the timing source option to measure frequency and timing:
 - **Internal:** Internal clock uses an internal oscillator in case of external reference is not available and the instrument does not transmit signal to synchronized equipment. The instrument provides the clock to the unit under test and most cases in Loopback test mode.
 - **RX:** Transmit clock uses the frequency recovered from the received signal (Network Loop), if accurate frequency measurement is required.
7. Toggle the **TX LBO** soft key between **0 dB** and **-6 dB** and select the level for TX Line Build Out.
8. Toggle the **CRC-4** soft key between **On** and **Off** to activate or deactivate the CRC-4.

NOTE

CRC-4 is used to detect errors in blocks of data transmitted across communication links. The detection is determined by a formula applied at both ends of transmit and receive. E1 uses a four-bit CRC (CRC-4) for error checking.

To start or stop testing:

1. Press the **MEASURE** hot key.
2. Press the **BERT** soft key, and then select the testing option as needed: **Start**, **Stop**, or **Clear**.

To select the error injection type:

1. Press the **Error Injection** soft key, and then select the error injection type: **None**, **1E-3**, **1E-4**, **1E-5**, or **Single**.

Optional. You can save event records automatically by using the **Save Result as CSV Format** soft key. See “Using save” on page 31 for more information.

Measurement example

Figure 255 E1 BERT testing for framing PCM30



NOTE
Bit Error is not supported for the framing type PCM30.

Using T1 Analyzer

This chapter provides instructions for using the T1 Analyzer function (option 005). Topics discussed in this chapter are as follows:

■ Introduction	495
■ Display overview	495
■ Connecting a cable	496
■ Monitoring transmission.....	497
■ Performing BERT testing	498
■ Performing RX signal testing	500
■ Performing loop testing.....	502

Introduction

The T1 is what telephone companies have traditionally used to transport digitized telephone conversations between central offices. As early as the 1960's, a single T1 circuit made it possible for a telephone company to deliver 24 high quality voice conversations. T1 is a fully digitalized service with no possibility of crosstalk, which is common in analog carrier networks where copper pairs pickup emissions from neighboring pairs. Significant increases in noise immunity were also achieved by adopting this new digital transmission standard.

Since the early 1980's, T1 service has been available to private industry throughout the country. This document will discuss the various types of T1 measurement items, how to measure them, and understand the general guidelines of T1 analysis using the JD785A Base Station Analyzer.

This portable test instrument can be a useful tool to check the overall health of the transmission system and assist in locating the source of problems or defects. The T1 Analyzer function provides following measurements:

- Monitoring
- RX Signal Level
- BERT Testing
- Loop Testing

Display overview

Figure 256 provides descriptions for each segment of the measurement screen.

Figure 256 T1 analyzer screen



Connecting a cable

Out-of-service testing

Figure 257 Point-to-point connection

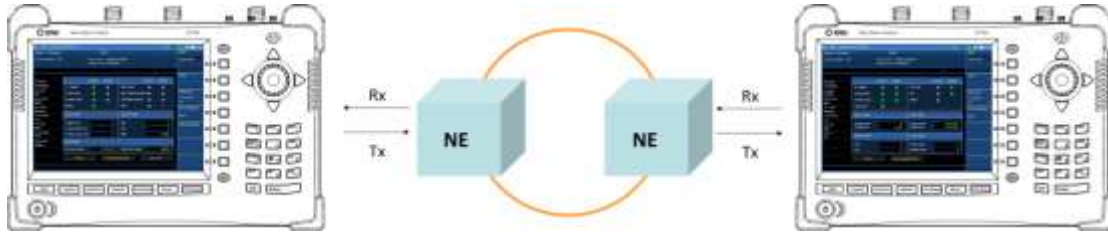

Figure 258 Loop-back connection

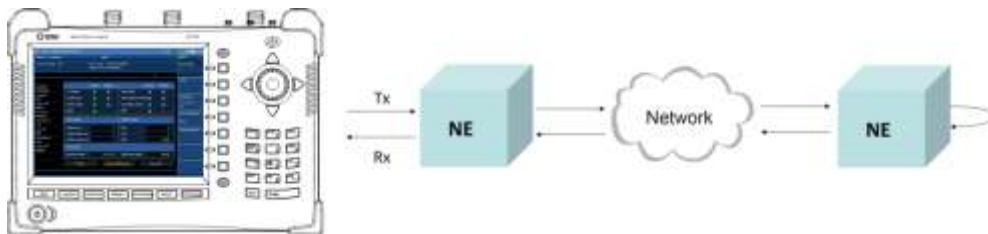
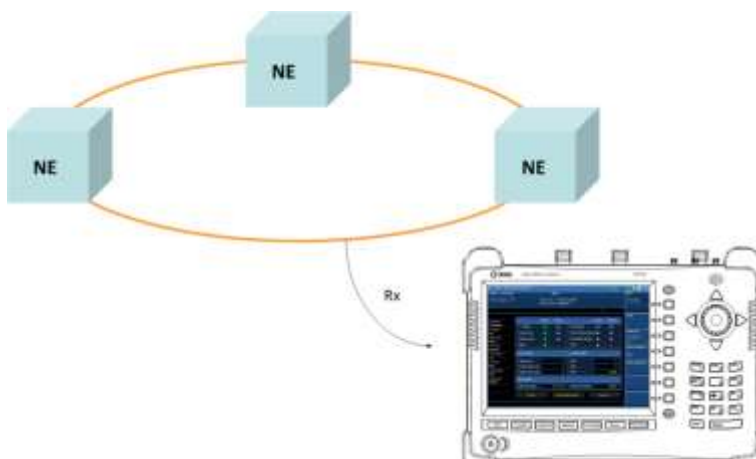

Figure 259 Error injection and measurement connection



In-service monitoring

Figure 260 In-service connection



Monitoring transmission

Making a test

Procedure

To select the measurement mode:

1. Press the **MODE** hard key.
2. Press the **E1/T1 Analyzer** soft key.
3. Select **T1 Analyzer > Monitoring**.

To configure measurement parameters:

1. Press the **MEASURE SETUP** hot key.
2. Press the **RX Mode** soft key, and then select the receiver input option from the following choices:
 - **Terminate**: Provides 100-ohm nominal input impedance, according to the framing, line code, and BER pattern settings.
 - **Bridge**: Provides input impedance greater than one kilohm for in-service monitoring, bridging the receiver input across lines that are terminated elsewhere in the network.
 - **Monitor**: Provides 100-ohm nominal input impedance for the in-service monitoring of T1 lines.
3. Toggle the **Framing** soft key between **SF-D4** and **ESF** and select the framing type for your receiver setting:
 - **SF-D4 (Super Frame-D4)**: Group of 12 frames, used to align equipment for framing.
 - **ESF (Extended Super Frame)**: Group of 24 frames, used to align equipment for framing. 4K for a maintenance channel (Facilities Data Link), 2K for CRC-6 checksum, and 2K for framing/synchronization.

NOTE

If the framing type does not match with your receiver setting, a framing alarm occurs.

4. Toggle the **Line Code** soft key between **AMI** and **B8ZS** and select the line code type to send an T1 signal:
 - **AMI**: It stands for Alternate Mark Inversion. A line code uses one three level signal to convey binary digits in which successive binary ones ("marks" or pulses) are of alternating polarity, either positive or negative, equal in amplitude. A binary zero ("space") is transmitted as no pulse or zero amplitude.
 - **B8ZS**: It stands for Bipolar with 8-Zero Substitution. A coding scheme in which the transmitter "substitutes" a fixed pattern of ones, zeros, and BPVs in place of 8 consecutive zeros.

To start or stop monitoring:

1. Press the **MEASURE** hot key.
2. Press the **Monitoring** soft key, and then select the monitoring option as needed: **Start**, **Stop**, or **Clear**.

Optional. You can save event records automatically by using the **Save Result as CSV Format** soft key. See "Using save" on page 31 for more information.

Measurement example

Figure 261 T1 transmission monitoring



Performing BERT testing

Making a test

Procedure

To select the measurement mode:

1. Press the **MODE** hard key.
2. Press the **E1/T1 Analyzer** soft key.
3. Select **T1 Analyzer > BERT**.

To configure measurement parameters:

1. Press the **MEASURE SETUP** hot key.
2. Press the **RX Mode** soft key, and then select the receiver input option from the following choices:
 - **Terminate:** Provides 100-ohm nominal input impedance, according to the framing, line code, and BER pattern settings.
 - **Bridge:** Provides input impedance greater than one kilohm for in-service monitoring, bridging the receiver input across lines that are terminated elsewhere in the network.
 - **Monitor:** Provides 100-ohm nominal input impedance for the in-service monitoring of T1 lines.
3. Toggle the **Framing** soft key between **SF-D4** and **ESF** and select the framing type for your receiver setting:
 - **SF-D4 (Super Frame-D4):** Group of 12 frames, used to align equipment for framing.
 - **ESF (Extended Super Frame):** Group of 24 frames, used to align equipment for framing. 4K for a maintenance channel (Facilities Data Link), 2K for CRC-6 checksum, and 2K for framing/synchronization.

NOTE

If the framing type does not match with your receiver setting, a framing alarm occurs.

-
4. Toggle the **Line Code** soft key between **AMI** and **B8ZS** and select the line code type to send an T1 signal:
 - **AMI:** It stands for Alternate Mark Inversion. A line code uses one three level signal to convey binary digits in which successive binary ones ("marks" or pulses) are of alternating polarity, either positive or negative, equal in amplitude. A binary zero ("space") is transmitted as no pulse or zero amplitude.
 - **B8ZS:** It stands for Bipolar with 8-Zero Substitution. A coding scheme in which the transmitter "substitutes" a fixed pattern of ones, zeros, and BPVs in place of 8 consecutive zeros.
 5. Press the **Pattern** soft key, and then select the stress pattern option from the following choices:
 - **1-8:** An eight-bit pattern that contains a single one, being used to test clock recovery.
 - **1-16:** A sixteen-bit pattern that contains a single one, being used to test clock recovery.
 - **All 1'S:** A pattern that causes line drivers to consume the maximum power.
 - **All 0'S:** A pattern that is often selected to verify HDB3 provisioning. Circuit will drop if optioned for AMI.
 - **Alternate:** A pattern that alternates between ones and zeroes.
 - **3-24:** A twenty-four bit-pattern containing 3 ones with the longest length of consecutive zeroes constrained to fifteen. It has ones density of 12.5% and is used to check clock recovery.
 - **QRSS:** A pseudorandom pattern that is a common test pattern and simulates live traffic on a circuit.
 - **2e23:** A pseudorandom pattern based on a 23 bit shift register.
 - **2e15:** A pseudorandom pattern based on a 15 bit shift register.
 - **2e23 INV:** Bit inversed pseudorandom pattern based on a 23 bit shift register.
 - **2e15 INV:** Bit inversed pseudorandom pattern based on a 15 bit shift register.
 6. Toggle the **TX Clock** soft key between **Internal** and **RX** and select the timing source option to measure frequency and timing:
 - **Internal:** Internal clock uses an internal oscillator in case of external reference is not available and the instrument does not transmit signal to synchronized equipment. The instrument provides the clock to the unit under test and most cases in Loopback test mode.
 - **RX:** Transmit clock uses the frequency recovered from the received signal (Network Loop), if accurate frequency measurement is required.
 7. Press the **TX LBO** soft key, and then select the level for TX Line Build Out option from the following choices:
 - **0 dB:** Is used in most cases including that the test set is connected to the DSX front panel, to CSU, to NIU or Channel Bank or that the cabling is less than about 130 feet in-between test set and DSX.
 - **-7.5 dB:** Is used in cases that attenuation is needed where the T1 line is series connected to 7.5 dB attenuator.
 - **-15 dB:** Is used in cases that attenuation is needed where the T1 line is series connected to 15 dB attenuator.

To start or stop testing:

1. Press the **MEASURE** hot key.
2. Press the **BERT** soft key, and then select the testing option as needed: **Start**, **Stop**, or **Clear**.

To select the error injection type:

1. Press the **Error Injection** soft key, and then select the error injection type: **None**, **1E-3**, **1E-4**, **1E-5**, or **Single**.

To set the error injection optios:

1. Press the **Alarm Injection** soft key.
2. Toggle the **AIS Alarm** soft key between **On** and **Off** to enable or disable the Alarm Indication Signal.
3. Toggle the **RAI Alarm** soft key between **On** and **Off** to enable or disable the Remote Alarm Indication.

Optional. You can save event records automatically by using the **Save Result as CSV Format** soft key. See “Using save” on page 31 for more information.

Measurement example

Figure 262 T1 BERT testing



Performing RX signal testing

Making a test

Procedure

To select the measurement mode:

1. Press the **MODE** hard key.
2. Press the **E1/T1 Analyzer** soft key.
3. Select **T1 Analyzer > RX Signal**.

To configure measurement parameters:

1. Press the **MEASURE SETUP** hot key.
2. Press the **RX Mode** soft key, and then select the receiver input option from the following choices:
 - **Terminate:** Provides 100-ohm nominal input impedance, according to the framing, line code, and BER pattern settings.
 - **Bridge:** Provides input impedance greater than one kilohm for in-service monitoring, bridging the receiver input across lines that are terminated elsewhere in the network.

- **Monitor:** Provides 100-ohm nominal input impedance for the in-service monitoring of T1 lines.
- 3. Toggle the **Framing** soft key between **SF-D4** and **ESF** and select the framing type for your receiver setting:
 - **SF-D4 (Super Frame-D4):** Group of 12 frames, used to align equipment for framing.
 - **ESF (Extended Super Frame):** Group of 24 frames, used to align equipment for framing. 4K for a maintenance channel (Facilities Data Link), 2K for CRC-6 checksum, and 2K for framing/synchronization.

NOTE
If the framing type does not match with your receiver setting, a framing alarm occurs.

- 4. Toggle the **Line Code** soft key between **AMI** and **B8ZS** and select the line code type to send an T1 signal:
 - **AMI:** It stands for Alternate Mark Inversion. A line code uses one three level signal to convey binary digits in which successive binary ones (“marks” or pulses) are of alternating polarity, either positive or negative, equal in amplitude. A binary zero (“space”) is transmitted as no pulse or zero amplitude.
 - **B8ZS:** It stands for Bipolar with 8-Zero Substitution. A coding scheme in which the transmitter “substitutes” a fixed pattern of ones, zeros, and BPVs in place of 8 consecutive zeros.

To start or stop testing:

1. Press the **MEASURE** hot key.
2. Press the **RX Signal** soft key, and then select the testing option as needed: **Start**, **Stop**, or **Clear**.

Optional. You can save event records automatically by using the **Save Result as CSV Format** soft key. See “Using save” on page 31 for more information.

Measurement example

Figure 263 T1 RX signal testing



Performing loop testing

Making a test

Procedure

To select the measurement mode:

1. Press the **MODE** hard key.
2. Press the **E1/T1 Analyzer** soft key.
3. Select **T1 Analyzer > Loop Test**.

To configure measurement parameters:

1. Press the **MEASURE SETUP** hot key.
2. Press the **RX Mode** soft key, and then select the receiver input option from the following choices:
 - **Terminate**: Provides 100-ohm nominal input impedance, according to the framing, line code, and BER pattern settings.
 - **Bridge**: Provides input impedance greater than one kilohm for in-service monitoring, bridging the receiver input across lines that are terminated elsewhere in the network.
 - **Monitor**: Provides 100-ohm nominal input impedance for the in-service monitoring of T1 lines.
3. Toggle the **Framing** soft key between **SF-D4** and **ESF** and select the framing type for your receiver setting:
 - **SF-D4 (Super Frame-D4)**: Group of 12 frames, used to align equipment for framing.
 - **ESF (Extended Super Frame)**: Group of 24 frames, used to align equipment for framing. 4K for a maintenance channel (Facilities Data Link), 2K for CRC-6 checksum, and 2K for framing/synchronization.

NOTE

If the framing type does not match with your receiver setting, a framing alarm occurs.

4. Toggle the **Line Code** soft key between **AMI** and **B8ZS** and select the line code type to send an T1 signal:
 - **AMI**: It stands for Alternate Mark Inversion. A line code uses one three level signal to convey binary digits in which successive binary ones ("marks" or pulses) are of alternating polarity, either positive or negative, equal in amplitude. A binary zero ("space") is transmitted as no pulse or zero amplitude.
 - **B8ZS**: It stands for Bipolar with 8-Zero Substitution. A coding scheme in which the transmitter "substitutes" a fixed pattern of ones, zeros, and BPVs in place of 8 consecutive zeros.
 5. Press the **Pattern** soft key, and then select the stress pattern option from the following choices:
 - **1-8**: An eight-bit pattern that contains a single one, being used to test clock recovery.
 - **1-16**: A sixteen-bit pattern that contains a single one, being used to test clock recovery.
 - **All 1'S**: A pattern that causes line drivers to consume the maximum power.
 - **All 0'S**: A pattern that is often selected to verify HDB3 provisioning. Circuit will drop if optioned for AMI.
 - **Alternate**: A pattern that alternates between ones and zeroes.
 - **3-24**: A twenty-four bit-pattern containing 3 ones with the longest length of consecutive zeroes constrained to fifteen. It has ones density of 12.5% and is used to check clock recovery.
 - **QRSS**: A pseudorandom pattern that is a common test pattern and simulates live traffic on a circuit.
-

-
- **2e23**: A pseudorandom pattern based on a 23 bit shift register.
 - **2e15**: A pseudorandom pattern based on a 15 bit shift register.
 - **2e23 INV**: Bit inversed pseudorandom pattern based on a 23 bit shift register.
 - **2e15 INV**: Bit inversed pseudorandom pattern based on a 15 bit shift register.
6. Toggle the **TX Clock** soft key between **Internal** and **RX** and select the timing source option to measure frequency and timing:
 - **Internal**: Internal clock uses an internal oscillator in case of external reference is not available and the instrument does not transmit signal to synchronized equipment. The instrument provides the clock to the unit under test and most cases in Loopback test mode.
 - **RX**: Transmit clock uses the frequency recovered from the received signal (Network Loop), if accurate frequency measurement is required.
 7. Press the **TX LBO** soft key, and then select the level for TX Line Build Out option from the following choices:
 - **0 dB**: Is used in most cases including that the test set is connected to the DSX front panel, to CSU, to NIU or Channel Bank or that the cabling is less than about 130 feet in-between test set and DSX.
 - **-7.5 dB**: Is used in cases that attenuation is needed where the T1 line is series connected to 7.5 dB attenuator.
 - **-15 dB**: Is used in cases that attenuation is needed where the T1 line is series connected to 15 dB attenuator.
 8. Press the **Loop Codes** soft key, and then do one of the following option:
 - To select the link option, toggle press the **Link** soft key between **Inband** and **Datalink**. Datalink is used when the framing is set to ESF.
 - To select the Channel Service Unit, press the **CSU** soft key.
 - To select the Network Interface Unit, press the **NIU** soft key.

To start or stop testing:

1. Press the **MEASURE** hot key.
2. Press the **Loop Test** soft key, and then select the testing option as needed: **Start**, **Stop**, or **Clear**.

To activate or deactivate the external loop back:

1. Press the **Remote Loop Up** to activate the external loop back so that the instrument sends the system a request of the loop back mode.
2. Press the **Remote Loop Dn** to deactivate the external loop back so that the instrument sends the system a request to clean the loop back mode.

To activate or deactivate the internal loop back:

1. Press the **Self Loop Up** to activate the internal loop back.
2. Press the **Self Loop Dn** to deactivate the internal loop back, reverting the instrument to a through mode.

To select the error injection type:

1. Press the **Error Injection** soft key, and then select the error injection type: **None**, **1E-3**, **1E-4**, **1E-5**, or **Single**.

To set the error injection options:

1. Press the **Alarm Injection** soft key.
 2. Toggle the **AIS Alarm** soft key between **On** and **Off** to enable or disable the Alarm Indication Signal.
-

3. Toggle the **RAI Alarm** soft key between **On** and **Off** to enable or disable the Remote Alarm Indication.

Optional. You can save event records automatically by using the **Save Result as CSV Format** soft key. See “Using save” on page 31 for more information.

Measurement example

Figure 264 T1 loop testing



Using Channel Scanner

This chapter provides instructions for using the Channel Scanner function (option 012). Topics discussed in this chapter are as follows:

■ Introduction	506
■ Display overview	506
■ Connecting a cable	506
■ Selecting measurement mode	508
■ Configuring test parameters	508
■ Making channel scanner measurements	511
■ Making frequency scanner measurements	512
■ Making custom scanner measurements	513
■ Analyzing measurements	515

Introduction

A Channel Scanner is a radio receiver that can automatically tune or scan two or more discrete frequencies and multi-channels, indicating when it finds a signal on one of them and then continuing scanning when that frequency goes silent.

You can measure up to 20 channels with this channel scanner. Using existing format-based or custom parameters, you will be able to easily verify improper multi-channel power levels.

- Channel Scanner
- Frequency Scanner
- Custom Scanner (Channel or Frequency)

Display overview

Figure 265 provides descriptions for each segment of the measurement screen.

Figure 265 Channel scanner screen



Connecting a cable

Direct connection

Procedure

1. Connect the **Spectrum Analyzer RF In** port of the JD780A series and the Power amplifier output port of BTS.

Figure 266 Direct connection

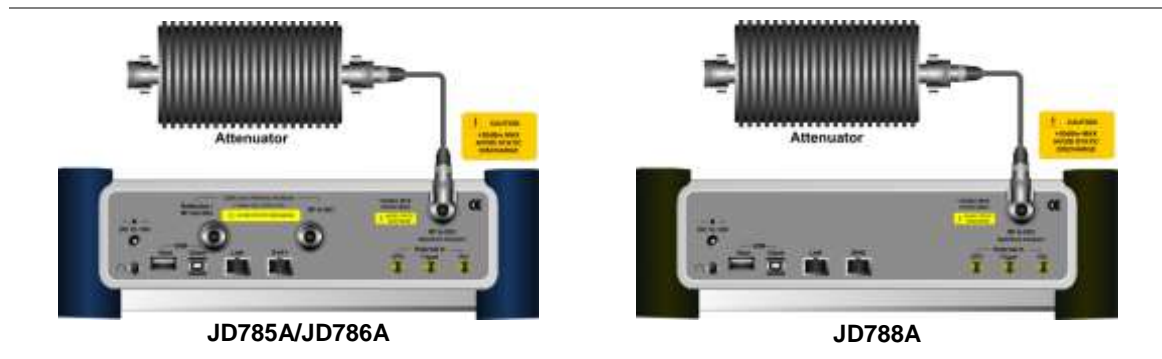

Indirect connection

Procedure

1. Connect the **Spectrum Analyzer RF In** port of the JD780A series and the monitor (test) port of BTS.

Figure 267 Indirect connection

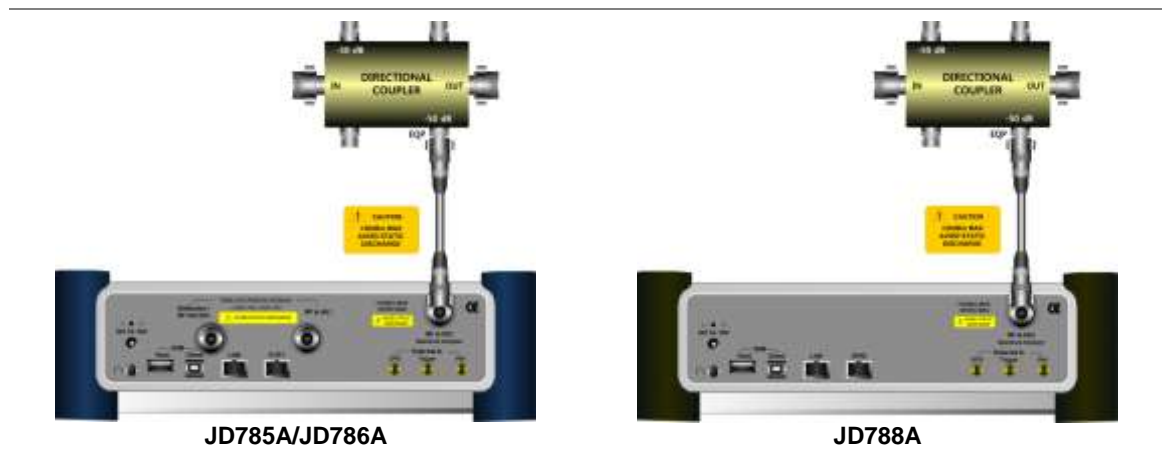

CAUTION

The maximum power for the **Spectrum Analyzer RF In** port is +25 dBm (0.316 W). If the input signal level to be measured is greater than +25 dBm, use a **High Power Attenuator** to prevent damage when you directly connect the signal to the instrument or connect the signal from the coupling port of a directional coupler.

Over the air (OTA)

Procedure

1. Connect an Omni/directional RF antenna to the **Spectrum Analyzer RF In** port of the JD780A series.
2. Connect a GPS antenna to the **GPS** port of the JD780A series.

Figure 268 OTA connection

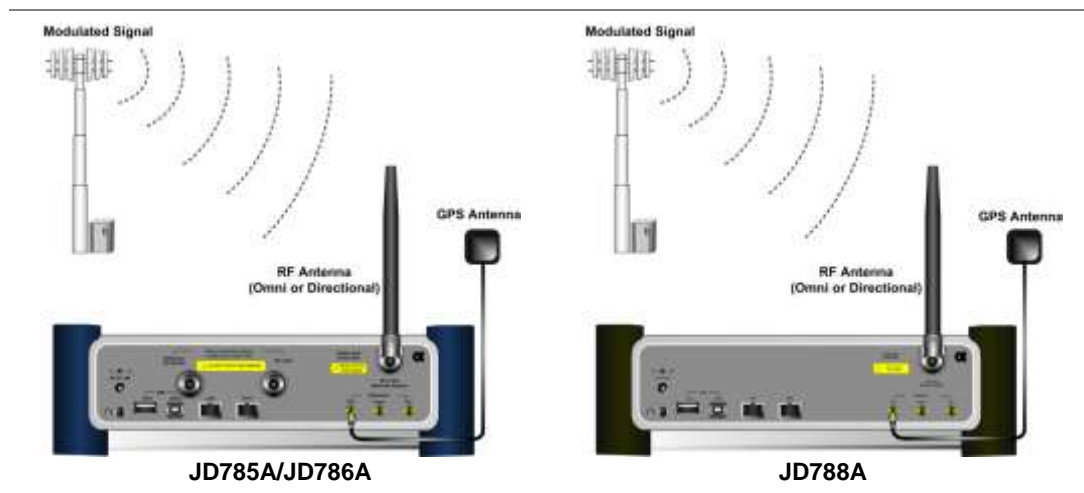

CAUTION

If the input signal level to be measured is less than 0 dBm, set 0 dB attenuation or turn on the preamp to have better dynamic range for the OTA testing.

Selecting measurement mode

Procedure

1. Press the **MODE** hard key.
2. Press the **Channel Scanner** soft key. The Channel Scanner mode is selected by default.
3. To change the measurement mode, press the **MEASURE** hot key and then select the measurement mode:
 - Channel Scanner
 - Frequency Scanner
 - Custom Scanner

Configuring test parameters

Setting frequency

You need to set the channel or frequency to be scanned depending on the scanner mode: channel scanner, frequency scanner, and custom scanner. Refer to each scanner mode for how to set the channel or frequency.

Setting amplitude

Reference level and attenuation

You can set the reference and attenuation levels automatically or manually to optimize the display of the traces measured, as you desire.

Procedure

To automatically set the reference and attenuation level:

1. Press the **AMP/SCALE** hard key.
2. Press the **Auto Scale** soft key.
Each time you press this key, both of the Y-axis scale and input attenuation level change to be optimized with some margin.

To set the reference or attenuation level manually:

1. Press the **AMP/SCALE** hard key.
2. To set the maximum reference value on the Y-axis manually, complete the following steps:
 - a. Press the **Reference Level** soft key.
 - b. Enter a value by using the numeric keys or the rotary knob with 10 dB increments.
 - c. Press the **dBm** soft key or the **ENTER** hard key.
3. To set the attenuation option, select one from the following choices:
 - To set the input attenuator's level automatically, select **Attenuation > Auto**.

NOTE

It is recommended that you set the **Attenuation** to **Auto** in most situations so that the level of the input attenuator can be set automatically according to your input signal level.

- To set the input attenuation manually up to 55 dB to optimize S/N, complete the following steps:
 - a. Select **Attenuation > Manual**.
 - b. Press the **Attenuation Value** soft key to set the level.
 - c. Enter a value between 0 and 55 in fives by using the numeric keys.
 - d. Press the **dB** soft key or the **ENTER** hard key.
- To couple the input attenuator's level with your reference level setting, select **Attenuation > Couple**.
As you increase the reference setting, the attenuation level also increases accordingly.

Optional. To change the scale unit:

1. Select **More (1/2) > Units**.
 2. Select the unit of the display scale: **dBm**, **dBV**, **dBmV**, **dBμV**, **V**, or **W**.
The scale unit on the screen changes accordingly.
-

Pre-amplifier

You can turn the internal pre-amplifier on to correct and compensate for the gain of the preamp so that amplitude readings show the value at the input connector.

Procedure

1. Press the **AMP/SCALE** hard key.
 2. Toggle the **Preamp** soft key and select **On** or **Off** as needed.
-

NOTE

You can turn the Preamp on when the input attenuation range is from 0 dB to 10 dB. If the attenuation value is manually set to greater than 10 dB, the instrument will automatically turn off the pre-amplifier to display low-level signal properly on the chart.

External offset

You can turn the **External Offset** on and manually set the external offset value. An offset consists of a cable loss and a user offset and the measurement result shows the value reflecting both offset values. When the external offset value is set at 40 dB in the Spectrum mode, the measurement result compensates 40 dB at both the Spectrum Analyzer and Signal Analyzer modes

Procedure

To set the external offset:

1. Press the **AMP/SCALE** hard key.
2. Toggle the **External Offset** soft key and select **On**.
3. Enter a value by using the numeric keys.
4. Press the **dB** soft key to complete the entry.

To turn the external offset off:

1. Press the **AMP/SCALE** hard key.
 2. Toggle the **External Offset** soft key and select **Off**.
-

Setting average

You can set the number of measurements to be averaged for the trace presentation. A maximum of 100 times of averaging can be set. When the averaging reaches to your setting, a new measurement value replaces the measurement value in sequence from the earliest.

Procedure

1. Press the **BW/AVG** hard key.
 2. Press the **Average** soft key.
 3. Enter a value between 1 and 100 as needed by using the numeric keys.
 4. Press the **Enter** soft key.
-

Setting sweep mode

The default settings of the sweep mode are **Continue** and **Normal** to sweep continuously at a normal speed for most on-going measurements. If you want to hold the measurement or get a single sweep, you can change the sweep mode.

Procedure

To select the single sweep mode:

1. Press the **SWEEP** hot key.
2. Toggle the **Sweep Mode** soft key and select **Single**. You can also use the **HOLD** hot key. The letter **HOLD** in red appears and the sweeping is paused.
3. *Optional.* Press the **Sweep Once** soft key to get a new measurement.

To return to the continuous sweep mode:

1. Toggle the **Sweep Mode** soft key and select **Continue**. You can also use the **HOLD** hot key. The letter **HOLD** in red disappears and the sweeping resumes.
-

NOTE

Selecting **Sweep Mode > Fast** may reduce the measurement accuracy, but you can use this fast sweep mode to identify the existence of interfering signals.

Making channel scanner measurements

Setting channel

You need to set the channel to be scanned.

Procedure

1. Press the **FREQ/DIST** hard key.
 2. To select the standard channel, complete the following steps:
 - a. Press the **Channel Std** soft key. The standard channel window appears. See "Appendix C – Band, frequency & channel standard" on page 541 for more information.
 - b. Select the band to be measured by using the rotary knob, the arrow keys, or the **Page Up/Page Down** soft keys.
 - c. Press the **Select** soft key or the rotary knob to confirm the selection.
 3. Toggle the **Link** soft key to select the scanning direction and select **Fwd** for forward or **Rev** for reverse.
 4. To set the starting channel, complete the following steps:
 - a. Press the **Start Channel** soft key.
 - b. Enter a value by using the numeric keys. You can also use the rotary knob.
 - c. Press the **Enter** soft key.
 5. To set the amount of channel increment in scanning channels, complete the following steps:
 - a. Press the **Channel Step** soft key.
 - b. Enter a value by using the numeric keys. You can also use the rotary knob.
 - c. Press the **Enter** soft key.
 6. To set the integration bandwidth, complete the following steps:
 - a. Press the **Integration Bandwidth** soft key.
 - b. Enter a value by using the numeric keys. You can also use the rotary knob.
 - c. Select the unit: **GHz**, **MHz**, **kHz**, or **Hz**.
 7. To set the number of channels to be displayed in the measurement table, complete the following steps:
 - a. Press the **# of Channels** soft key.
 - b. Enter a value by using the numeric keys. You can also use the rotary knob.
 - c. Press the **Enter** soft key.
-

Measurement example

Test results can be saved as a *.csv file format so that you can work on it in any spreadsheet software.

Figure 269 Channel scanner measurement



NOTE

You can use the **LIMIT** hot key to analyze your measurements with the display line and channel limit. See “Setting limit for channel scanner” on page 515 for more information.

Making frequency scanner measurements

Setting frequency

You need to set the frequency to be scanned.

Procedure

1. Press the **FREQ/DIST** hard key.
2. To set the starting center frequency, complete the following steps:
 - a. Press the **Start Frequency** soft key.
 - b. Enter a value by using the numeric keys. You can also use the rotary knob.
 - c. Select the unit: **GHz**, **MHz**, **kHz**, or **Hz**.
3. To set the amount of frequency increment in scanning channels, complete the following steps:
 - a. Press the **Frequency Step** soft key.
 - b. Enter a value by using the numeric keys. You can also use the rotary knob.
 - c. Select the unit: **GHz**, **MHz**, **kHz**, or **Hz**.
4. To set the integration bandwidth, complete the following steps:
 - a. Press the **Integration Bandwidth** soft key.
 - b. Enter a value by using the numeric keys. You can also use the rotary knob.
 - c. Select the unit: **GHz**, **MHz**, **kHz**, or **Hz**.
5. To set the number of frequencies to be displayed in the measurement table, complete the following steps:
 - a. Press the **# of Frequency** soft key.
 - b. Enter a value by using the numeric keys. You can also use the rotary knob.

- c. Press the **Enter** soft key.

Measurement example

Figure 270 Frequency scanner measurement



NOTE

You can use the **LIMIT** hot key to analyze your measurements with the display line and channel limit. See "Setting limit for channel scanner" on page 515 for more information.

Making custom scanner measurements

Setting channel/frequency

You can customize channels or frequencies to be scanned as you desire.

Procedure

To set the channels to be scanned:

1. Press the **FREQ/DIST** hard key.
2. Toggle the **Unit** soft key and select **Channel**.
3. To select the standard channel, complete the following steps:
 - a. Press the **Channel Std** soft key. The standard channel window appears. See "Appendix C – Band, frequency & channel standard" on page 541 for more information.
 - b. Select the band to be measured by using the rotary knob, the arrow keys, or the **Page Up/Page Down** soft keys.
 - c. Press the **Select** soft key or the rotary knob to confirm the selection.
4. Toggle the **Link** soft key to select the scanning direction and select **Fwd** for forward or **Rev** for reverse.
5. Press the **Index** soft key, and then enter an index number by turning the rotary knob or using the numeric keys.
6. To set the channel number for the selected index, complete the following steps:

- a. Press the **Channel Number** soft key.
- b. Enter a value by using the numeric keys. You can also use the rotary knob.
- c. Press the **Enter** soft key.

The instrument displays a corresponding center frequency for the channel number.

7. To set the integration bandwidth for the selected index, complete the following steps:
 - a. Press the **Integration Bandwidth** soft key.
 - b. Enter a value by using the numeric keys. You can also use the rotary knob.
 - c. Select the unit: **GHz**, **MHz**, **kHz**, or **Hz**.
8. To add more channels to be scanned, repeat steps **5-7**.
9. Press the **ESC** hard key to dismiss the channel list window and view the scanning result.

To set the frequencies to be scanned:

1. Press the **FREQ/DIST** hard key.
 2. Toggle the **Unit** soft key and select **Freq**.
 3. Press the **Index** soft key, and then enter an index number by turning the rotary knob or using the numeric keys.
 4. To set the center frequency for the selected index, complete the following steps:
 - a. Press the **Center Frequency** soft key.
 - b. Enter a value by using the numeric keys. You can also use the rotary knob.
 - c. Select the unit: **GHz**, **MHz**, **kHz**, or **Hz**.
 5. To set the integration bandwidth for the selected index, complete the following steps:
 - a. Press the **Integration Bandwidth** soft key.
 - b. Enter a value by using the numeric keys. You can also use the rotary knob.
 - c. Select the unit: **GHz**, **MHz**, **kHz**, or **Hz**.
 6. To add more channels to be scanned, repeat steps **3-5**.
 7. Press the **ESC** hard key to dismiss the channel list window and view the scanning result.
-

Measurement example

Figure 271 Custom scanner measurement



NOTE

You can use the **LIMIT** hot key to analyze your measurements with the display line and channel limit. See "Setting limit for channel scanner" on page 515 for more information.

Analyzing measurements

Setting limit for channel scanner

Procedure

To use the display line:

1. Press the **LIMIT** hot key.
2. Press the **Display Line** soft key to set a threshold for the limit line and Pass/Fail indication.
3. Enter a value, and then press the **dBm** unit soft key.
4. Toggle the **Display Line** soft key between **On** and **Off** to display or dismiss the limit line.

To use the channel limit:

1. Press the **LIMIT** hot key.
2. Press the **Channel Limit** soft key to set the limits for each channel index.
3. Press the **Index** soft key, and then select the channel/frequency index number by turning the rotary knob or using the numeric keys.
4. Toggle the **Limit** soft key between **On** and **Off** to enable or disable the Pass/Fail indication.
5. Set the upper threshold:
 - a. Press the **High Limit** soft key.
 - b. Enter a value for the upper limit.
 - c. Press the **dBm** unit soft key.
6. Set the lower threshold:
 - a. Press the **Low Limit** soft key.

- b.** Enter a value for the lower limit.
 - c.** Press the **dBm** unit soft key.
 - 7.** *Optional.* Go to **SAVE/LOAD > Save**, and then select the save option from the choices available for your measurement mode. See “Using save” on page 31 for more information.
-

Using Power Meter

This chapter provides instructions for using the RF Power Meter function and the Optical Power Meter function. Topics discussed in this chapter are as follows:

- Introduction519
- Display overview519
- Performing internal RF power measurements.....519
- Performing external RF power measurements.....524
- Performing optical power measurements527
- Setting limit for power meter530

Introduction

The Power Meter of the JD780A series uses power measurement based on spectrum measurement results to provide an accurate power measurement result unlike a general spectrum analyzer, of which power accuracy may be degraded if the span is set too wide.

The power meter also provides Pass/Fail indication with user-defined lower and upper limits.

The Power Meter function provides following measurements:

- Internal RF Power Measurement
- External RF Power Measurement
- Optical Power Measurement

Display overview

Figure 272 provides descriptions for each segment of the measurement screen.

Figure 272 Power measurement screen



Performing internal RF power measurements

The internal power measurement of the JD780A series collects powers from the raw data of spectrum analyzer in the optimal span and integrates the powers up to the specified user span, which results in an accurate power measurement, independent of the span setting.

Connecting a cable

Direct connection

Procedure

1. Connect the **Spectrum Analyzer RF In** port of the JD780A series and the Power amplifier output port of BTS as shown in Figure 273.

Figure 273 Direct connection



Indirect connection

Procedure

1. Connect the **Spectrum Analyzer RF In** port of the JD780A series and the monitor (test) port of BTS as shown in Figure 274.

Figure 274 Indirect connection

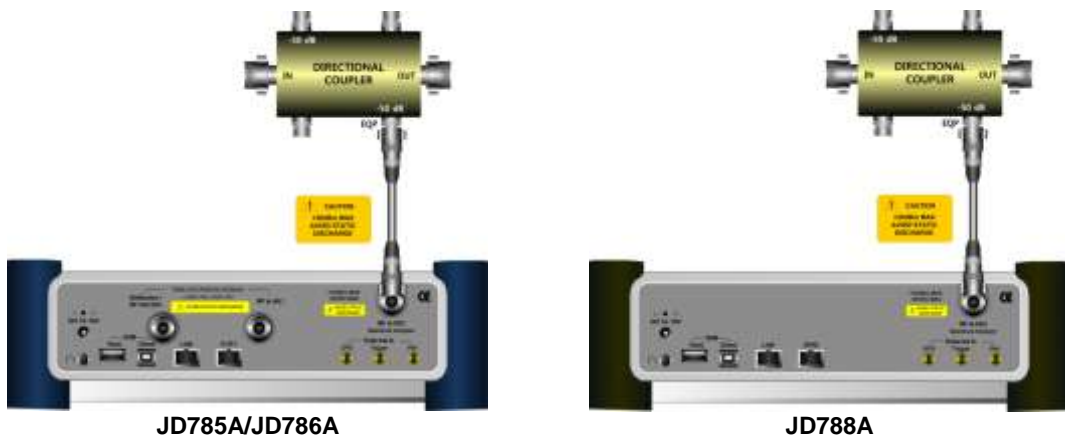

CAUTION

The maximum power for the **Spectrum Analyzer RF In** port is +25 dBm (0.316 W). If the input signal level to be measured is greater than +25 dBm, use a **High Power Attenuator** to prevent damage when you directly connect the signal to the instrument or connect the signal from the coupling port of a directional coupler.

Selecting measurement mode

Procedure

1. Press the **MODE** hard key.
 2. Select **More (1/2) > Power Meter > Internal RF Power Meter**.
-

Setting frequency

You need to set the frequency range to be measured either with the center frequency and span or with the start and stop frequencies. You can also set the frequency with the channel number and span.

Procedure

To set the center frequency and span:

1. Press the **FREQ/DIST** hard key.
2. Toggle the **Unit** soft key and select **Freq**.
3. Press the **Center Frequency** soft key.
4. Enter a value by using the numeric keys. You can also use the rotary knob or the arrow keys.
5. Select the unit: **GHz**, **MHz**, **kHz**, or **Hz**.
6. Press the **Span** soft key, and then do one of the following:
 - To set the span manually, select **Span**, enter a value, and then select the unit.
 - To set the span automatically, select **Full Span**, **Zero Span**, or **Last Span** as needed.

NOTE

The **Zero Span** option is available only in the Spectrum mode. If you have selected **Zero Span**, select **TRIGGER > Free Run**, **External**, **GPS**, **Video**, or **Display Position**.

To set the start and stop frequencies:

1. Press the **FREQ/DIST** hard key.
2. Toggle the **Unit** soft key and select **Freq**.
3. Press the **Start Frequency** soft key.
4. Enter a value by using the numeric keys. You can also use the rotary knob or the arrow keys.
5. Select the unit: **GHz**, **MHz**, **kHz**, or **Hz**.
6. Press the **Stop Frequency** soft key.
7. Enter a value by using the numeric keys. You can also use the rotary knob or the arrow keys.
8. Select the unit: **GHz**, **MHz**, **kHz**, or **Hz**.

To set the channel number and span:

1. Press the **FREQ/DIST** hard key.
 2. Toggle the **Unit** soft key and select **Channel**.
 3. To select the standard channel, complete the following steps:
 - a. Press the **Channel Std** soft key. The standard channel window appears. See "Appendix C – Band, frequency & channel standard" on page 541 for more information.
 - b. Select the band to be measured by using the rotary knob, the arrow keys, or the **Page Up/Page Down** soft keys.
 - c. Press the **Select** soft key or the rotary knob to confirm the selection.
-

4. Toggle the **Link** soft key to select the sweep direction and select **Fwd** for forward or **Rev** for reverse.
5. To set the channel number, complete the following steps:
 - a. Press the **Channel Number** soft key.
 - b. Enter a value by using the numeric keys.
 - c. Press the **Enter** soft key or **ENTER** hard key to complete the entry.
The instrument automatically displays the corresponding center frequency value for the selected channel number.
6. To set the span, complete the following steps:
 - a. Press the **Span** soft key.
 - b. Select the span option, from the following choices:
 - To set the span manually, select **Span**, enter a value, and then select the unit.
 - To set the span automatically, select **Full Span**, **Zero Span**, or **Last Span** as needed.

NOTE

The **Zero Span** option is available only in the Spectrum mode. If you have selected **Zero Span**, select **TRIGGER > Free Run, External, GPS, Video, or Display Position**.

Optional. To define the amount of frequency increment for the rotary knob:

1. Press the **Frequency Step** soft key, if the **Freq** is selected.
2. Enter a value by using the numeric keys.
3. Press the unit: **GHz**, **MHz**, **kHz**, or **Hz**.

Optional. To define the amount of channel increment for the rotary knob:

1. Press the **Channel Step** soft key, if the **Channel** is selected.
2. Enter a value by using the numeric keys.
3. Press the **Enter** soft key.

Setting amplitude

Procedure

1. Press the **AMP/SCALE** hard key.
2. Toggle the **Display** soft key and select the display method: **Relative** or **Absolute**.
3. If the **Relative** is selected, press the **Set Reference** soft key to set the current value as the reference.
4. To specify the display range, complete the following steps:
 - a. Press the **Display Maximum** soft key to set the maximum value for the power meter.
 - b. Enter a value by using the numeric keys. You can also use the rotary knob.
 - c. Press the **dBm** soft key.
 - d. Press the **Display Minimum** soft key to set the minimum value for the power meter.
 - e. Enter a value by using the numeric keys. You can also use the rotary knob.
 - f. Press the **dBm** soft key.
5. *Optional.* To enable the external offset, complete the following steps:
 - a. Toggle the **External Offset** soft key and select **On**.
 - b. Enter a value between 0 and 60 by using the numeric keys.

-
- c. Press the **dB** soft key.
-

Setting sweep mode

The default setting of the sweep mode is **Continue**. If you want to hold the measurement, you can change the sweep mode.

Procedure

To select the single sweep mode:

1. Press the **SWEEP** hot key.
 2. To select the single sweep mode, toggle the **Sweep Mode** soft key and select **Single**. You can also use the **HOLD** hot key.
The letter **HOLD** in red appears and the sweeping is paused.
 3. To return to the continuous sweep mode, toggle the **Sweep Mode** soft key and select **Continue**. You can also use the **HOLD** hot key.
The letter **HOLD** in red disappears and the sweeping resumes.
-

Making a measurement

Procedure

1. Press the **MEASURE SETUP** hot key.
 2. Press the **Resolution** soft key, and then select the resolution option from the following choices:
 - **0** to display the reading with no decimal place
 - **1** to display the reading with one decimal place
 - **2** to display the reading with two decimal places
 3. To set the resolution bandwidth, complete the following steps:
 - a. Press the **RBW** soft key.
 - b. Enter a value by using the numeric keys.
 - c. Press the unit: **MHz**, **kHz**, or **Hz**.
 4. Press the **Accuracy Mode** soft key, and then select the accuracy mode option: **Low**, **Middle**, and **High**.
 5. To specify the number of measurements to be averaged, complete the following steps:
 - a. Press the **Average** soft key.
 - b. Enter a value between 1 and 100 by using the numeric keys.
 - c. Press the **Enter** soft key.
-

Measurement example

Figure 275 Internal power measurement



NOTE

You can use the **LIMIT** hot key to analyze your measurements with the user-definable limit and Pass/Fail indication. See “Setting limit for power meter” on page 530 for more information.

Performing external RF power measurements

This instrument performs radio output power measurement with the use of optional external power sensors including JD730 series power sensors. It serves as the highly accurate RF power meter and gives wider range of power measurement.

Connecting a cable

There are two types of power sensors. Directional power sensors are used in in-service power measurement. Terminating power sensors are used in out-of-service power measurement.

Table 23 External power sensor type

Part No.	Description	Frequency Range	Power Range
JD731B	Directional Power Sensor	300-3800 MHz	Average: +21.76 to +51.76 dBm (0.15 to 150 W) Peak: +36.02 to +56.02 dBm (4 to 400 W)
JD732B	Terminating Power Sensor	20-3800 MHz	Average: -30 to +20 dBm
JD733A	Directional Power Sensor	150-3500 MHz	Average/Peak: +20 to +47 dBm (0.1 to 50 W)
JD734B	Terminating Power Sensor	20-3800 MHz	Peak: -30 to +20 dBm
JD736B	Terminating Power Sensor	20-3800 MHz	Average/Peak: -30 to +20 dBm

Terminating power sensor connection

Procedure

1. Connect an external power sensor to the **USB Host** port of the JD780A series and to the RF output port of BTS.
The JD780A series automatically detects and initializes the power sensor connected to the instrument. Connecting an external power sensor is mandatory.

Table 24 Terminating power sensor connection

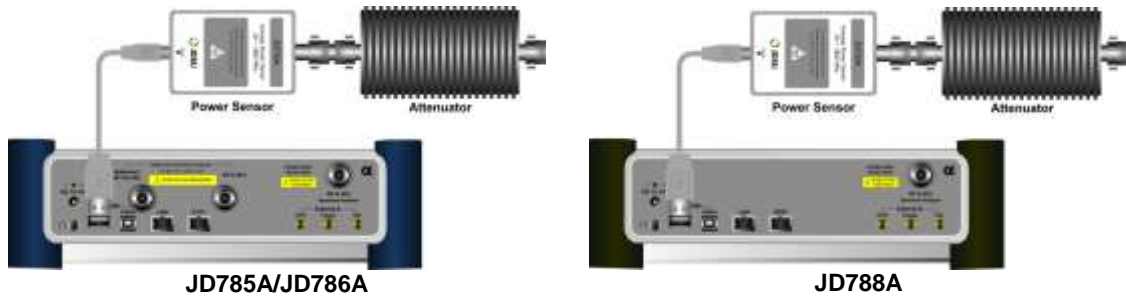

Directional power sensor connection

Procedure

1. Connect an external power sensor to the **USB Host** port of the JD780A series and to the RF output port of BTS as shown in Figure 276.
The JD780A series automatically detects and initializes the power sensor connected to the instrument. Connecting an external power sensor is mandatory.

Figure 276 Directional power sensor connection



Selecting measurement mode

Procedure

1. Press the **MODE** hard key.
2. Select **More (1/2) > Power Meter > External RF Power Meter**.

Setting frequency

You need to set the frequency to be measured depending on your connected external power sensor.

Procedure

1. Press the **FREQ/DIST** hard key.
 2. Press the **Frequency** soft key.
 3. Enter a value by using the numeric keys. You can also use the rotary knob.
 4. Select the unit: **GHz**, **MHz**, **kHz**, or **Hz**.
-

Setting amplitude

Procedure

1. Press the **AMP/SCALE** hard key.
 2. Toggle the **Display** soft key and select the display method: **Relative** or **Absolute**.
 3. If the **Relative** is selected, press the Set Reference soft key to set the current value as the reference.
 4. To specify the display range, complete the following steps:
 - a. Press the **Display Maximum** soft key to set the maximum value for the power meter.
 - b. Enter a value by using the numeric keys. You can also use the rotary knob.
 - c. Press the **dBm** soft key.
 - d. Press the **Display Minimum** soft key to set the minimum value for the power meter.
 - e. Enter a value by using the numeric keys. You can also use the rotary knob.
 - f. Press the **dBm** soft key.
 5. *Optional.* To enable the external offset, complete the following steps:
 - a. Toggle the **External Offset** soft key and select **On**.
 - b. Enter a value between 0 and 60 by using the numeric keys.
 - c. Press the **dB** soft key.
-

Making a measurement

Procedure

1. Press the **MEASURE** hot key.
 2. Depending your connected power sensor, do one of the following:
 - For JD736B, select the power range option: **Average Power**, **Peak Power**, or **Pulse Power**.
 - For JD734B, select **Peak Power**.
 - For JD732B, select **Average Power**.
 - For JD731B, select the power range option: **Forward Avg Power**, **Reverse Avg Power**, **Forward Peak Power**, **Pulse Power**, or **VSWR**.
 - For JD733A, select the power range option: **Forward Avg Power**, **Reverse Avg Power**, **Forward Peak Power**, or **VSWR**.
 3. Press the **MEASURE SETUP** hot key.
-

4. Press the **Resolution** soft key, and then select the resolution option from the following choices:
 - 0 to display the reading with no zero decimal place
 - 1 to display the reading with one decimal place
 - 2 to display the reading with two decimal places

Measurement example

You can measure and understand a trend of a system output in operation where output power constantly varies depending on the amount of calls being processed by the BTS or Repeater. In addition, the Log graph benefits you to easily examine the discontinuance of output power caused by the transmission problems or defective connection.

Figure 277 External power measurement of pulse power



NOTE

You can use the **LIMIT** hot key to analyze your measurements with the user-definable limit and Pass/Fail indication. See “Setting limit for power meter” on page 530 for more information.

Performing optical power measurements

The optical power measurement is available in conjunction with MP-series power sensor, which measures optical power via a USB connection.

Connecting a cable

There are two types of optical power sensors.

Table 25 Optical power sensors

Part No.	Wavelength Range	Dynamic Range
MP-60A	780-1650 nm	1300, 1310, 1490, 1550 nm: -50 to +10 dBm

		850 nm: -45 to +10 dBm
MP-80A	780-1650 nm	1300, 1550 nm: -35 to +23 dBm 980 nm: -30 to +23 dBm

Optical power sensor connection

Procedure

1. Connect a MP-series optical power sensor to the **USB Host** port of the JD780A series as shown in Figure 278.

Figure 278 Optical power sensor connection



Selecting measurement mode

Procedure

1. Press the **MODE** hard key.
2. Select **More (1/2) > Power Meter > Optical Power Meter**.

Setting amplitude

Procedure

1. Press the **AMP/SCALE** hard key.
2. Toggle the **Display** soft key and select the display method: **Relative** or **Absolute**.
3. If the **Relative** is selected, press the Set Reference soft key to set the current value as the reference.
4. To specify the display range, complete the following steps:
 - a. Press the **Display Maximum** soft key to set the maximum value for the power meter.
 - b. Enter a value by using the numeric keys. You can also use the rotary knob.
 - c. Press the **dBm** soft key.
 - d. Press the **Display Minimum** soft key to set the minimum value for the power meter.
 - e. Enter a value by using the numeric keys. You can also use the rotary knob.
 - f. Press the **dBm** soft key.
5. *Optional.* To enable the external offset, complete the following steps:

- a. Toggle the **External Offset** soft key and select **On**.
- b. Enter a value between 0 and 60 by using the numeric keys.
- c. Press the **dB** soft key.

Making a measurement

Procedure

1. Press the **MEASURE SETUP** hot key.
2. Toggle the **Wavelength** soft key and select the wavelength option:
 - To set the wave length automatically, select **Auto**.
 - To select the wave length from the standard wave list, select **StdWave**. The StdWave soft key becomes activated.
3. Press the **StdWave** soft key, and then select the standard wavelength option: **850 nm**, **980 nm**, **1300 nm**, **1310 nm**, **1480 nm**, **1490 nm**, or **1550 nm**.
4. Press the **Resolution** soft key, and then select the resolution option from the following choices:
 - **0** to display the reading with nodedecimal place
 - **1** to display the reading with one decimal place
 - **2** to display the reading with two decimal places

Measurement example

Figure 279 optical power measurement



NOTE

You can use the **LIMIT** hot key to analyze your measurements with the user-definable limit and Pass/Fail indication. See "Setting limit for power meter" on page 530 for more information.

Setting limit for power meter

You can use the **Limit** hot key to set the threshold for the Pass/Fail indication.

Procedure

1. Press the **LIMIT** hot key.
 2. Toggle the **Limit** soft key between **On** and **Off** to enable or disable the Pass/Fail indication.
 3. To set the upper and lower limits, complete the following steps:
 - a. Press the **High Limit** soft key.
 - b. Enter a value for the upper threshold by using the numeric keys.
 - c. Press the **dBm** unit soft key.
 - a. Press the **Low Limit** soft key.
 - b. Enter a value for the lower threshold by using the numeric keys.
 - c. Press the **dBm** unit soft key.
 4. *Optional.* Go to **SAVE/LOAD > Save**, and then select the save option from the choices available for your measurement mode. See "Using save" on page 31 for more information.
-

Performing Fiber Inspection

This chapter provides instructions for using the fiber testing function with a P5000i fiberscope. Topics discussed in this chapter are as follows:

■ Introduction	532
■ Display overview	532
■ Connecting a fiber microscope	532
■ Selecting measurement mode	533
■ Configuring test parameters	533
■ Performing fiber inspection	534

Introduction

Inspection of fiber optic connections is essential for the optimal performance and longevity of fiber optic connectivity. Throughout their lives, fiber connectors must be inspected, analyzed, and cleaned to maintain an acceptable level of functionality. The JD780A series makes it fast and easy to troubleshoot and certify that every connection at a cell site is optimized for a lifetime of performance.

The JD780A series supports the handheld fiber microscope P5000i that can capture video images from the sensor and analyzes the images for fiber end face defects and contamination with reliable PASS/FAIL results to guarantee the performance of your optical connections.

Display overview

Figure 272 provides descriptions for each segment of the measurement screen.

Figure 280 Fiber inspection screen

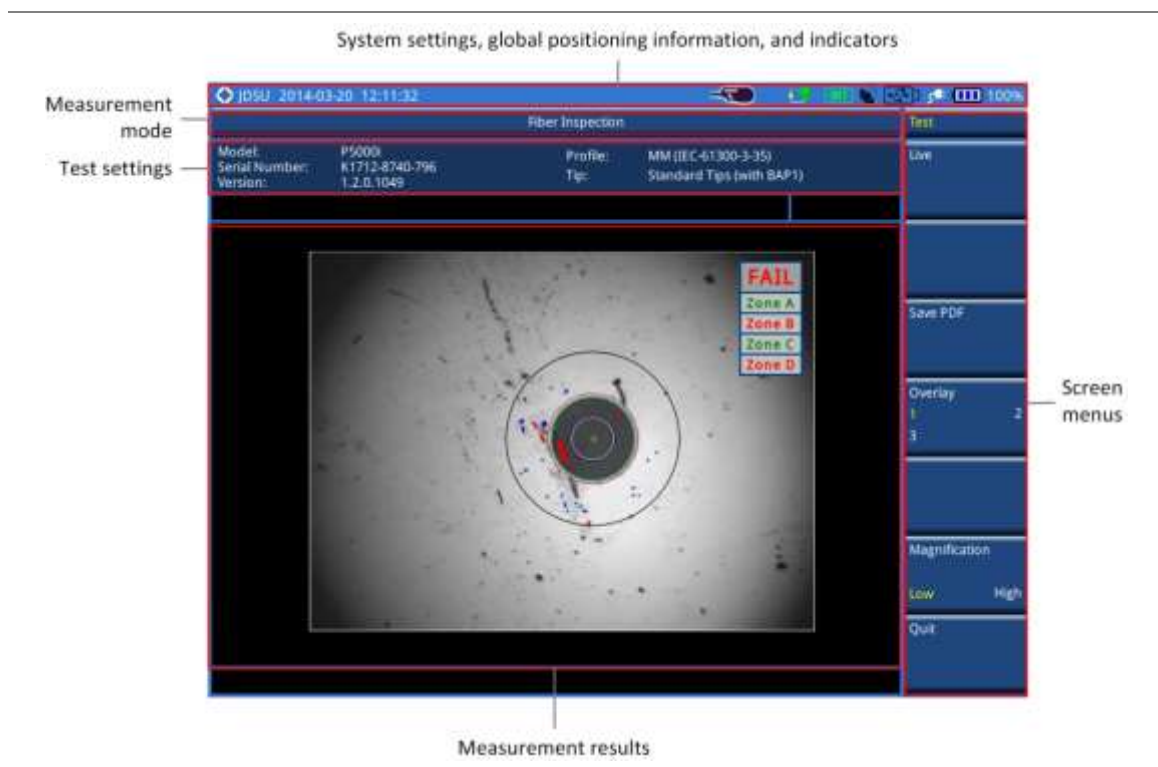

Connecting a fiber microscope

Connecting an optional fiber microscope P5000i is mandatory for fiber inspection and analysis. See “JD780A Series Common Options” on page 555 for available options.

Procedure

1. Connect your fiber microscope P5000i to the **USB Host** port of the JD780A series. The instrument detects the connected microscope automatically and displays the icon.

Selecting measurement mode

Procedure

1. Press the **MODE** hard key.
 2. Select **More (1/2) > Fiber Inspection**.
-

Configuring test parameters

Selecting profile and tip

You can select analysis profiles and inspection tips from the list.

Procedure

1. Press the **MEASURE SETUP** hot key.
2. Press the **Profile & Tip** soft key.
The profile and tip pane appears.
3. To select one of the pre-configured analysis profiles that match the PASS/FAIL criteria in the IEC visual inspection standard, complete the following steps:
 - a. Tap the drop-down list button for the **Profile**.
 - b. Select the profile that you want to use, from the following choices:
 - **MM (IEC-61300-3-35)**
 - **Ribbon, MM (IEC-61300-3-35)**
 - **Ribbon, SM APC (IEC-61300-3-35)**
 - **SM APC (IEC-61300-3-35)**
 - **SM PC (IEC-61300-3-35)**
 - **SM UPC (IEC-61300-3-35)**

NOTE

All of the profiles are factory set and cannot be edited or removed.

4. To select the inspection tip (optical settings) that you want to use, complete the following steps:
 - a. Tap the drop-down list button for the **Tip**.
 - b. Select one of the tips available to your selected profile, from the following choices:
 - **Standard Tips (with BAP1) and Simplex Long Reach (-L) Tips**
 - **Ribbon Tips and Ribbon Tips – Long Reach**

NOTE

This setting allows you to select the best optical settings for the type of inspection tip that is attached to your microscope probe.

5. Tap the **Apply** button or press the **Apply** soft key to save and return to the previous state.
-

Setting preferences

You can set your preferences of auto center and QuickCapture button function. The QuickCapture button is the small grey round button on the side of the microscope.

Procedure

1. To set the function of the QuickCapture button on the side of the P5000i, toggle the **Test Button** soft key and select the option from the following choices:
-

- **Test:** Sets the capture button to function as Test. Pressing the Quickcapture button analyzes fiber image as like the **Test** soft key on your JD780A series.
 - **Freeze:** Sets the capture button to function as Freeze. Pressing the Quickcapture button captures fiber image as like the **Freeze** soft key on your JD780A series.
2. To turn the auto center feature on or off, toggle the **Auto Center** soft key between **On** and **Off** and select the option you want to set. Default setting is **On**. It automatically displays the center of the fiber when viewing at high magnification.
-

Performing fiber inspection

Capturing fiber image

Procedure

1. Connect the fiber to be inspected to the tip of your microscope P5000i.
The live image of the fiber is displayed on the screen.
See the user manual of your fiber microscope for details on using the P5000i.
 2. Focus the image by rotating the **Focus Control** on the P5000i until the image is in focus.
 3. Toggle the **Magnification** soft key between **Low** and **High** and select the option you want to use.
You can also press the **Magnification Control** button on either side of the P5000i.
 4. Press the **Freeze** soft key to capture the properly focused image.
The text “Capturing...” appears.
 5. *Optional.* To save the captured image as a file (.png), complete the following steps:
 - a. Tap the **Save PNG** soft key.
The Save window appears with the on-screen key.
 - b. Type a file name in the **File Name** field.
 - c. Select a folder where you want to save the file, if desired.
 - d. Press the **Save** soft key.
 6. Press the **Live** soft key to return to the live image screen or press the **Quit** soft key to exit.
-

Measurement example

Figure 281 Captured fiber image



Testing a fiber

Procedure

1. Connect the fiber to be inspected to the tip of your microscope P5000i.
The live image of the fiber is displayed on the screen.
See the user manual of your fiber microscope for details on using the P5000i.
2. Focus the image by rotating the **Focus Control** on the P5000i until the image is in focus.
3. Toggle the **Magnification** soft key between **Low** and **High** and select the option you want to use.
You can also press the **Magnification Control** button on either side of the P5000i.
4. Press the **Test** soft key to start fiber analysis.
The text "Analyzing..." appears.
5. Once the test is completed, check the result displayed on the screen with the following information:
 - Image overlay of the zone locations, defects, and scratches
 - PASS or FAIL result
 - Specific test result for each zone
6. To show or hide image overlays, press the **Overlay** soft key.
Each time this key is pressed, the selection changes.
7. *Optional.* To save the fiber inspection result with specific details as a report (.pdf), complete the following steps:
 - a. Tap the **Save PDF** soft key.
The Save window appears with the on-screen key.
 - b. Type a file name in the **File Name** field.
 - c. Select a folder where you want to save the file, if desired.
 - d. Press the **Save** soft key.
The information input window appears.
 - e. Type in information as required.

- f. Tap the **Apply** button or press the **Apply** soft key to save and return to the previous state.
- 8. Press the **Live** soft key to return to the live image screen or press the **Quit** soft key to exit the fiber inspection.

Measurement example

Figure 282 Analyzed fiber image and fiber inspection result



Figure 283 Fiber inspection report

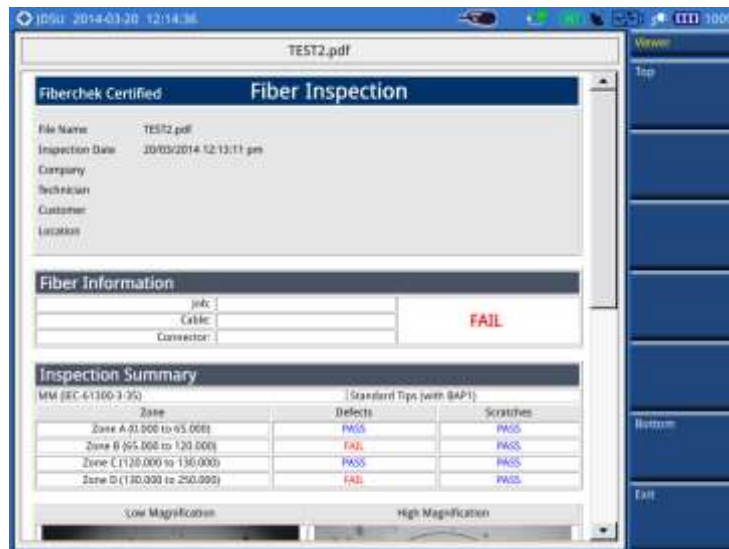



Appendix

Topics discussed in this chapter are as follows:

■ Appendix A – Product general information	538
■ Appendix B – Cable list	540
■ Appendix C – Band, frequency & channel standard.....	541
■ Appendix D – VSWR-Return loss conversion table	544
■ Appendix E – Cyclic prefix table	545
■ Appendix F – Motorola CDMA/EV-DO LMF	546
■ Appendix G – Bluetooth connection	548
■ Appendix H – Device driver installation	551
■ Appendix I – Ordering information.....	552
■ Appendix J – RoHS information	557
■ Appendix K – On-screen keyboard.....	558

Appendix A - Product general information

	JD785A/JD786A	JD788A	Supplemental Information
Inputs and Outputs			
RF In			Spectrum Analyzer
Connector	Type-N female	Type-N female	
Impedance	50 Ω	50 Ω	Nominal
Damage Level	>+33 dBm, >±50 V DC	>+33 dBm, >±50 V DC	Nominal
Reflection/RF Out			Cable and Antenna Analyzer
Connector	Type-N female	Type-N female	
Impedance	50 Ω	50 Ω	Nominal
Damage Level	>+40 dBm, >±50 V DC	>+40 dBm, >±50 V DC	Nominal
RF In			Cable and Antenna Analyzer
Connector	Type-N female	N/A	
Impedance	50 Ω	N/A	Nominal
Damage Level	>+25 dBm, >±50 V DC	N/A	Nominal
External Trigger, GPS			
Connector	SMA female	SMA female	
Impedance	50 Ω	50 Ω	Nominal
External Ref			
Connector	SMA female	SMA female	
Impedance	50 Ω	50 Ω	Nominal
Input Frequency	10, 13, 15 MHz	10, 13, 15 MHz	
Input Range	-5 to +5 dBm	-5 to +5 dBm	
USB			
USB Host	Type A, 1 port	Type A, 1 port	
USB Client	Type B, 1 port	Type B, 1 port	
LAN	RJ45, 10/100 Base-T	RJ45, 10/100 Base-T	
E1/T1	RJ45	N/A	Available in JD785A
GPIO	N/A	RJ45	Available in JD786A and JD788A
Audio Jack	3.5 mm headphone jack	3.5 mm headphone jack	
External Power	5.5 mm barrel connector	5.5 mm barrel connector	
Speaker	Built-in speaker	Built-in speaker	
Display			
Type	Resistive touch screen	Resistive touch screen	
Size	8"	8"	LCD backlight, transfective LCD with anti-glare coating
Resolution	800 x 600	800 x 600	

	JD785A/JD786A	JD788A	Supplemental Information
Power			
External DC Input	18 V DC	18 V DC	
Power Consumption	37 W	37 W	49 W maximum when charging battery
Battery			
Operating Time	10.8 V, 7800 mA-h > 3 hours (Typical)	10.8 V, 7800 mA-h > 3 hours (Typical)	Lithium Ion In balance mode
Charge Time	2.5 hours (80 %) 5 hours (100 %)	2.5 hours (80 %) 5 hours (100 %)	In case of a fully discharged battery
Storage Temperature	0 to 25°C (32 to 77°F)	0 to 25°C (32 to 77°F)	The battery pack should be stored in an environment with low humidity. Extended exposure to temperature above 45°C could degrade battery performance and life.
Data Storage			
Internal	Maximum 100 MB	Maximum 100 MB	Up to 3800 traces
External	Limited to the size of USB flash drive	Limited to the size of USB flash drive	Supports USB 2.0 compatible memory devices
Environmental			
Operating Temperature			
AC Power	0 to 40°C (32 to 104°F)	0 to 40°C (32 to 104°F)	With no derating
Battery	0 to 40°C (32 to 104°F) -10 to 55 °C (14 to 131 °F)	0 to 40°C (32 to 104°F) -10 to 55 °C (14 to 131 °F)	At charging At discharging
Maximum Humidity	95% RH	95% RH	Non-condensing
Shock and Vibration	MIL-PRF-28800F Class 2	MIL-PRF-28800F Class 2	
Storage Temperature	-30 to 71°C (-22 to 160°F)	-30 to 71°C (-22 to 160°F)	With the battery pack removed
EMC			
	IEC/EN 61326-1:2006 CISPR11:2009+A1:2010	IEC/EN 61326-1:2006 CISPR11:2009+A1:2010	Complies with European EMC
ESD			
	IEC/EN 61000-4-2	IEC/EN 61000-4-2	
Size and Weight (Standard Configuration)			
Weight	<4.3 kg (9.5 lb.)	<3.9 kg (8.6 lb.)	With battery
Size	295 x 195 x 82 (mm) 11.6 x 7.7 x 3.2 (Inch)	295 x 195 x 82 (mm) 11.6 x 7.7 x 3.2 (Inch)	Approximately (W x H x D)
Warranty			
	2 years	2 years	
Calibration Cycle			
	1 year	1 year	

Appendix B - Cable list

Cable Type	Relative Propagation Velocity (V _i)	Nominal Attenuation dB/m @ 1000 MHz
F SJ1-50A	0.84	0.197
F SJ250	0.83	0.134
F SJ4-50B	0.81	0.119
HCC 12-50J	0.915	0.092
HCC 158-50J	0.95	0.023
HCC 300-50J	0.96	0.014
HCC 312-50J	0.96	0.013
HCC 78-50J	0.915	0.042
HF 4-1/8" Cu2Y	0.97	0.01
HF 5" Cu2Y	0.96	0.007
HF 6-1/8" Cu2Y	0.97	0.006
HJ4.5-50	0.92	0.054
HJ4-50	0.914	0.087
HJ5-50	0.916	0.042
HJ7-50A	0.921	0.023
LDF12-50	0.88	0.022
LDF4-50A	0.88	0.077
LDF5-50A	0.89	0.043
LDF6-50	0.89	0.032
LDFF7-50A	0.88	0.027
LMR100	0.8	0.792
LMR1200	0.88	0.044
LMR1700	0.89	0.033
LMR200	0.83	0.344
LMR240	0.84	0.262
LMR400	0.85	0.135
LMR500	0.86	0.109
LMR600	0.87	0.087
LMR900	0.87	0.056
RG142	0.69	0.443
RG17, 17A	0.659	0.18
RG174	0.66	0.984
RG178B	0.69	1.509
RG187, 188	0.69	1.017
RG213/U	0.66	0.292
RG214	0.659	0.292
RG223	0.659	0.165
RG55, 55A, 55B	0.659	0.541
RG58, 58B	0.659	1.574
RG58A, 58C	0.659	0.787
RG8, 8A, 10, 10A	0.659	0.262
RG9, 9A	0.659	0.289
HFSC-12D(1/2")	0.81	0.112
HFC-12D(1/2")	0.88	0.072
HFC-22D(7/8")	0.88	0.041
HFC-33D(1_1/4")	0.88	0.0294
HFC-42D(1_5/8")	0.87	0.0243
RFCX-12D(1/2")	0.88	0.088
RFCX-22D(7/8")	0.88	0.049
RFCX-33D(1_1/4")	0.88	0.038
RFCX-42D(1_5/8")	0.87	0.028
RFCL-22D(7/8")	0.88	0.044
RFCL-33D(1_1/4")	0.88	0.034
RFCL-42D(1_5/8")	0.87	0.0315

Appendix C - Band, frequency & channel standard

Standard	Uplink			Downlink		
	Start Freq (MHz)	Stop Freq (MHz)	Valid Channels	Start Freq (MHz)	Stop Freq (MHz)	Valid Channels
GSM						
GSM 450	450.40	457.60	259≤n≤293	460.40	467.60	259≤n≤293
GSM 480	478.80	486.00	306≤n≤340	488.80	496.00	306≤n≤340
GSM 850	824.00	849.00	128≤n≤251	869.00	894.00	128≤n≤251
P-GSM 900	890.00	915.00	1≤n≤124	935.00	960.00	1≤n≤124
E-GSM 900	880.00	915.00	0≤n≤124	925.00	960.00	0≤n≤124
			975≤n≤1023			975≤n≤1023
R-GSM 900	876.00	915.00	0≤n≤124	921.00	960.00	0≤n≤124
			955≤n≤1023			955≤n≤1023
R-GSM 900 (China)	885.00	889.00	999≤n≤1019	930.00	934.00	999≤n≤1019
DCS 1800	1710.00	1785.00	512≤n≤885	1805.00	1880.00	512≤n≤885
PCS 1900	1850.00	1910.00	512≤n≤810	1930.00	1990.00	512≤n≤810
CDMA						
Band 0 (800)	824.00	849.00	1≤n≤799	869.00	894.00	1≤n≤799
			991≤n≤1023			991≤n≤1023
Band 1 (NA PCS)	1850.00	1910.00	0≤n≤1199	1930.00	1990.00	0≤n≤1199
Band 2 (TACS)	872.0125	914.9875	0≤n≤1000	917.0125	959.9875	0≤n≤1000
			1329≤n≤2047			1329≤n≤2047
Band 3 (JTACS)	887.0125	924.9875	1≤n≤799	832.0125	869.9875	1≤n≤799
			801≤n≤1039			801≤n≤1039
			1041≤n≤1199			1041≤n≤1199
			1201≤n≤1600			1201≤n≤1600
Band 4 (KR PCS)	1750.00	1780.00	0≤n≤599	1840.00	1870.00	0≤n≤599
Band 5 (450)	411.675	483.480	1≤n≤300	421.6750	493.4800	1≤n≤300
			539≤n≤871			539≤n≤871
			1039≤n≤1473			1039≤n≤1473
			1792≤n≤2016			1792≤n≤2016
Band 6 (2100)	1920.00	1980.00	0≤n≤1199	2100.00	2170.00	0≤n≤1199
Band 7 (700)	776.00	794.00	0≤n≤359	746.00	764.00	0≤n≤359
Band 8 (1800)	1710.00	1784.95	0≤n≤1499	1805.00	1879.95	0≤n≤1499
Band 9 (900)	880.00	914.95	0≤n≤699	925.00	959.95	0≤n≤699
Band 10 (2nd 800)	806.000	900.975	0≤n≤719	851.000	939.975	0≤n≤719
			720≤n≤919			720≤n≤919
WCDMA						
Band Global						
Band 1 (2100-General)	1920.0	1980.0	9612≤n≤9888	2110.0	2170.0	10562≤n≤10838
Band 2 (1900-General)	1850.0	1910.0	9262≤n≤9538	1930.0	1990.0	9662≤n≤9938
Band 2 (1900-Additional)			12≤n≤287			412≤n≤687
Band 3 (1800-General)	1710.0	1780.0	937≤n≤1288	1805.0	1880.0	1162≤n≤1513
Band 4 (1700-General)	1710.0	1775.0	1312≤n≤1513	2110.0	2155.0	1537≤n≤1738
Band 4 (1700-Additional)			1662≤n≤1862			1887≤n≤2087
Band 5 (850-General)	824.0	849.0	4132≤n≤4233	869.0	894.0	4357≤n≤4458
Band 5 (850-Additional)			782≤n≤862			1007≤n≤1087
Band 6 (800-General)	830.0	840.0	4162≤n≤4188	875.0	885.0	4387≤n≤4413
Band 6 (800-Additional)			812≤n≤837			1037≤n≤1062
Band 7 (2600-General)	2500.0	2570.0	2012≤n≤2338	2620.0	2690.0	2237≤n≤2563
Band 7 (2600-Additional)			2362≤n≤2687			2587≤n≤2912
Band 8 (900-General)	880.0	915.0	2712≤n≤2863	925.0	960.0	2937≤n≤3088
Band 9 (1700-General)	1749.9	1784.9	8762≤n≤8912	1844.9	1879.9	9237≤n≤9387
Band 10 (1700-General)	1710.0	1770.0	2887≤n≤3163	2110.0	2170.0	3112≤n≤3388
Band 10 (1700-Additional)			3187≤n≤3462			3412≤n≤3687
Band 11 (1500-General)	1427.9	1447.9	3487≤n≤3562	1475.9	1495.9	3712≤n≤3787
Band 12 (700-General)	699.0	716.0	3617≤n≤3678	729.0	746.0	3842≤n≤3903
Band 12 (700-Additional)			3707≤n≤3767			3932≤n≤3992
Band 13 (700-General)	777.0	787.0	3792≤n≤3818	746.0	756.0	4017≤n≤4043
Band 13 (700-Additional)			3842≤n≤3867			4067≤n≤4092
Band 14 (700-General)	788.0	798.0	3892≤n≤3918	758.0	768.0	4117≤n≤4143
Band 14 (700-Additional)			3942≤n≤3967			4167≤n≤4192
Band 19 (800-General)	830.0	845.0	312≤n≤363	875.0	890.0	712≤n≤763
Band 19 (800-Additional)			387≤n≤437			787≤n≤837
Band 20 (800-General)	832.0	862.0	4287≤n≤4413	791.0	821.0	4512≤n≤4638

JD780A Series Analyzers

Band 21 (1500-General)	1447.9	1462.9	462≤n≤512	1495.9	1510.9	862≤n≤912
Band 22 (3500-General)	3410.0	3490.0	4437≤n≤4813	3510.0	3590.0	4662≤n≤5038
Band 25 (1900-General)	1850.0	1915.0	4887≤n≤5188	1930.0	1995.0	5112≤n≤5413
Band 25 (1900-Additional)			5212≤n≤5512			5437≤n≤5737
Band 26 (800-General)	814.0	849.0	5537≤n≤5688	859.0	894.0	5762≤n≤5913
Band 26 (800-Additional)			5712≤n≤5862			5937≤n≤6087

LTE - FDD

Band Global						
Band 1 (2100)	1920.0	1980.0	18000≤n≤18599	2110.0	2170.0	0≤n≤599
Band 2 (1900)	1850.0	1910.0	18600≤n≤19199	1930.0	1990.0	600≤n≤1199
Band 3 (1800)	1710.0	1785.0	19200≤n≤19949	1805.0	1880.0	1200≤n≤1949
Band 4 (1700)	1710.0	1755.0	19950≤n≤20399	2110.0	2155.0	1950≤n≤2399
Band 5 (850)	824.0	849.0	20400≤n≤20649	869.0	894.0	2400≤n≤2649
Band 7 (2600)	2500.0	2570.0	20750≤n≤21449	2620.0	2690.0	2750≤n≤3449
Band 8 (900)	880.0	915.0	21450≤n≤21799	925.0	960.0	3450≤n≤3799
Band 9 (1700)	1749.9	1784.9	21800≤n≤22149	1844.9	1879.9	3800≤n≤4149
Band 10 (1700)	1710.0	1770.0	22150≤n≤22749	2110.0	2170.0	4150≤n≤4749
Band 11 (1500)	1427.9	1447.9	22750≤n≤22949	1475.9	1495.9	4750≤n≤4949
Band 12 (700)	699.0	716.0	23010≤n≤23179	729.0	746.0	5010≤n≤5179
Band 13 (700)	777.0	787.0	23180≤n≤23279	746.0	756.0	5180≤n≤5279
Band 14 (700)	788.0	798.0	23280≤n≤23379	758.0	768.0	5280≤n≤5379
Band 17 (700)	704.0	716.0	23730≤n≤23849	734.0	746.0	5730≤n≤5849
Band 18 (800)	815.0	830.0	23850≤n≤23999	860.0	875.0	5850≤n≤5999
Band 19 (800)	830.0	845.0	24000≤n≤24149	875.0	890.0	6000≤n≤6149
Band 20 (800)	832.0	862.0	24150≤n≤24449	791.0	821.0	6150≤n≤6449
Band 21 (1500)	1447.9	1462.9	24450≤n≤24599	1495.9	1510.9	6450≤n≤6599
Band 22 (3500)	3410.0	3490.0	24600≤n≤25399	3510.0	3590.0	6600≤n≤7399
Band 23 (2100)	2000.0	2020.0	25500≤n≤25699	2180.0	2200.0	7500≤n≤7699
Band 24 (1500)	1626.5	1660.5	25700≤n≤26039	1525.0	1559.0	7700≤n≤8039
Band 25 (1900)	1850.0	1915.0	26040≤n≤26689	1930.0	1995.0	8040≤n≤8689
Band 26 (800)	814.0	849.0	26690≤n≤27039	859.0	894.0	8690≤n≤9039

LTE - TDD

Band Global						
Band 33 (1900)	1900.0	1920.0	36000≤n≤36199			
Band 34 (2100)	2010.0	2025.0	36200≤n≤36349			
Band 35 (1850)	1850.0	1910.0	36350≤n≤36949			
Band 36 (1930)	1930.0	1990.0	36950≤n≤37549			
Band 37 (1910)	1910.0	1930.0	37550≤n≤37749			
Band 38 (2570)	2570.0	2620.0	37750≤n≤38249			
Band 39 (1880)	1880.0	1920.0	38250≤n≤38649			
Band 40 (2300)	2300.0	2400.0	38650≤n≤39649			
Band 41 (2496)	2496.0	2690.0	39650≤n≤41589			
Band 42 (3400)	3400.0	3600.0	41590≤n≤43589			
Band 43 (3600)	3600.0	3800.0	43590≤n≤45589			

TD-SCDMA

FBN 0	1785.0	1805.0	0≤n≤92			
FBN 1	1900.0	1920.0	0≤n≤92			
FBN 2	1920.0	1980.0	0≤n≤255			
FBN 3	1920.0	1980.0	0≤n≤36			
FBN 4	1980.0	2010.0	0≤n≤142			
FBN 5	2010.0	2025.0	0≤n≤67			
FBN 6	2100.0	2170.0	0≤n≤255			
FBN 7	2100.0	2170.0	0≤n≤36			
FBN 8	2170.0	2220.0	0≤n≤242			

WiMAX

ProfR1 (1.25 2150)	2150.625	2159.375	0≤n≤7			
ProfR2 (1.25 2305)	2305.625	2320.625	0≤n≤12			
ProfR3 (1.25 2361)	2361.875	2375.625	13≤n≤24			
ProfR4 (1.25 2500)	2500.625	2688.125	0≤n≤150			
ProfR5 (1.25 3400)	3400.625	3700.625	0≤n≤240			
ProfR6 (3.5 2598)	2524.750	2591.250	0≤n≤38	2598.750	2665.250	0≤n≤38
ProfR7 (3.5 3461)	3411.750	3443.250	0≤n≤18	3461.750	3493.250	0≤n≤18
ProfR8 (3.5 3551)	3501.750	3598.000	0≤n≤55	3551.750	3648.000	0≤n≤55
ProfR9 (3.5 3651)	3601.750	3698.000	0≤n≤55	3651.750	3748.000	0≤n≤55
ProfR10 (3.5 3751)	3701.750	3798.000	0≤n≤55	3751.750	3848.000	0≤n≤55
ProfR11 (7 2600)	2526.500	2589.500	0≤n≤36	2600.500	2663.500	0≤n≤36
ProfR12 (7 3463)	2413.500	3441.500	0≤n≤16	3463.500	3491.500	0≤n≤16
ProfR13 (7 3553)	3503.500	3596.250	0≤n≤53	3553.500	3646.250	0≤n≤53

JD780A Series Analyzers

ProfR14 (7 3653)	3603.500	3696.250	0≤n≤53	3653.50	3746.25	0≤n≤53
ProfR15 (7 3753)	3703.500	3796.250	0≤n≤53	3753.50	3846.25	0≤n≤53
ProfR26 (10 5275)	5275.000	5335.000	55≤n≤67			
ProfR27 (10 5740)	5740.000	5830.000	148≤n≤166			
ProfR28 (10 5735)	5735.000	5845.000	147≤n≤169			
ProfR29 (8.75 2304)	2304.375	2395.625	0≤n≤730			

Appendix D - VSWR-Return loss conversion table

This information is for the Cable and Antenna Analyzer mode of the JD785A Base Station Analyzer and the JD786A RF Analyzer.

- $\text{Return Loss} = 20 \log_{10}(\text{VSWR} + 1 / \text{VSWR} - 1)$ (dB)
- $\text{VSWR} = (10^{\text{R.L./20}} + 1) / (10^{\text{R.L./20}} - 1)$

VSWR	Return Loss (dB)	Trans. Loss (dB)	Volt. Refl Coeff	Power Trans (%)	Power Refl (%)	VSWR	Return Loss (dB)	Trans. Loss (dB)	Volt. Refl Coeff	Power Trans (%)	Power Refl (%)
1.00	--	0.000	0.00	100.0	0.0	1.64	12.3	0.263	0.24	94.1	5.9
1.01	46.1	0.000	0.00	100.0	0.0	1.66	12.1	0.276	0.25	93.8	6.2
1.02	40.1	0.000	0.01	100.0	0.0	1.68	11.9	0.289	0.25	93.6	6.4
1.03	36.6	0.001	0.01	100.0	0.0	1.70	11.7	0.302	0.26	93.3	6.7
1.04	34.2	0.002	0.02	100.0	0.0	1.72	11.5	0.315	0.26	93.0	7.0
1.05	32.3	0.003	0.02	99.9	0.1	1.74	11.4	0.329	0.27	92.7	7.3
1.06	30.7	0.004	0.03	99.9	0.1	1.76	11.2	0.342	0.28	92.4	7.6
1.07	29.4	0.005	0.03	99.9	0.1	1.78	11.0	0.356	0.28	92.1	7.9
1.08	28.3	0.006	0.04	99.9	0.1	1.80	10.9	0.370	0.29	91.8	8.2
1.09	27.3	0.008	0.04	99.8	0.2	1.82	10.7	0.384	0.29	91.5	8.5
1.10	26.4	0.010	0.05	99.8	0.2	1.84	10.6	0.398	0.30	91.3	8.7
1.11	25.7	0.012	0.05	99.7	0.3	1.86	10.4	0.412	0.30	91.0	9.0
1.12	24.9	0.014	0.06	99.7	0.3	1.88	10.3	0.426	0.31	90.7	9.3
1.13	24.3	0.016	0.06	99.6	0.4	1.90	10.2	0.440	0.31	90.4	9.6
1.14	23.7	0.019	0.07	99.6	0.4	1.92	10.0	0.454	0.32	90.1	9.9
1.15	23.1	0.021	0.07	99.5	0.5	1.94	9.9	0.468	0.32	89.8	10.2
1.16	22.6	0.024	0.07	99.5	0.5	1.96	9.8	0.483	0.32	89.5	10.5
1.17	22.1	0.027	0.08	99.4	0.6	1.98	9.7	0.497	0.33	89.2	10.8
1.18	21.7	0.030	0.08	99.3	0.7	2.00	9.5	0.512	0.33	88.9	11.1
1.19	21.2	0.033	0.09	99.2	0.8	2.50	7.4	0.881	0.43	81.6	18.4
1.20	20.8	0.036	0.09	99.2	0.8	3.00	6.0	1.249	0.50	75.0	25.0
1.21	20.4	0.039	0.10	99.1	0.9	3.50	5.1	1.603	0.56	69.1	30.9
1.22	20.1	0.043	0.10	99.0	1.0	4.00	4.4	1.938	0.60	64.0	36.0
1.23	19.7	0.046	0.10	98.9	1.1	4.50	3.9	2.255	0.64	59.5	40.5
1.24	19.4	0.050	0.11	98.9	1.1	5.00	3.5	2.553	0.67	55.6	44.4
1.25	19.1	0.054	0.11	98.8	1.2	5.50	3.2	2.834	0.69	52.1	47.9
1.26	18.8	0.058	0.12	98.7	1.3	6.00	2.9	3.100	0.71	49.0	51.0
1.27	18.5	0.062	0.12	98.6	1.4	6.50	2.7	3.351	0.73	46.2	53.8
1.28	18.2	0.066	0.12	98.5	1.5	7.00	2.5	3.590	0.75	43.7	56.3
1.29	17.9	0.070	0.13	98.4	1.6	7.50	2.3	3.817	0.76	41.5	58.5
1.30	17.7	0.075	0.13	98.3	1.7	8.00	2.2	4.033	0.78	39.5	60.5
1.32	17.2	0.083	0.14	98.1	1.9	8.50	2.1	4.240	0.79	37.7	62.3
1.34	16.8	0.093	0.15	97.9	2.1	9.00	1.9	4.437	0.80	36.0	64.0
1.36	16.3	0.102	0.15	97.7	2.3	9.50	1.8	4.626	0.81	34.5	65.5
1.38	15.9	0.112	0.16	97.5	2.5	10.00	1.7	4.807	0.82	33.1	66.9
1.40	15.8	0.122	0.17	97.2	2.8	11.00	1.6	5.149	0.83	30.6	69.4
1.42	15.2	0.133	0.17	97.0	3.0	12.00	1.5	5.466	0.85	28.4	71.6
1.44	14.9	0.144	0.18	96.7	3.3	13.00	1.3	5.762	0.86	26.5	73.5
1.46	14.6	0.155	0.19	96.5	3.5	14.00	1.2	6.040	0.87	24.9	75.1
1.48	14.3	0.166	0.19	96.3	3.7	15.00	1.2	6.301	0.88	23.4	76.6
1.50	14.0	0.177	0.20	96.0	4.0	16.00	1.1	6.547	0.88	22.1	77.9
1.52	13.7	0.189	0.21	95.7	4.3	17.00	1.0	6.780	0.89	21.0	79.0
1.54	13.4	0.201	0.21	95.5	4.5	18.00	1.0	7.002	0.89	19.9	80.1
1.56	13.2	0.213	0.22	95.2	4.8	19.00	0.9	7.212	0.90	19.0	81.0
1.58	13.0	0.225	0.22	94.9	5.1	20.00	0.9	7.413	0.90	18.1	81.9
1.60	12.7	0.238	0.23	94.7	5.3	25.00	0.7	8.299	0.92	14.8	85.2
1.62	12.5	0.250	0.24	94.4	5.6	30.00	0.6	9.035	0.94	12.5	87.5

Appendix E - Cyclic prefix table

This information is for the LTE – FDD Signal Analyzer mode and the LTE – TDD Signal Analyzer mode of the JD785A Base Station Analyzer and the JD788A Signal Analyzer. Following table shows OFDM parameter details by different bandwidth.

Bandwidth	Configuration (Downlink)		Cyclic Prefix Length	
			TS	μs
20 MHz	Normal CP	Δf=15 kHz	160 for $l=0$	5.208
			144 for $l=1,2,..,6$	4.6875
	Extended CP	Δf=15 kHz	512 for $l=0,1,..,5$	16.667
Δf=7.5 kHz			1024 for $l=0,1,2$	33.333
15 MHz	Normal CP	Δf=15 kHz	120 for $l=0$	5.208
			108 for $l=1,2,..,6$	4.6875
	Extended CP	Δf=15 kHz	384 for $l=0,1,..,5$	16.667
Δf=7.5 kHz			768 for $l=0,1,2$	33.333
10 MHz	Normal CP	Δf=15 kHz	80 for $l=0$	5.208
			72 for $l=1,2,..,6$	4.6875
	Extended CP	Δf=15 kHz	256 for $l=0,1,..,5$	16.667
Δf=7.5 kHz			512 for $l=0,1,2$	33.333
5 MHz	Normal CP	Δf=15 kHz	40 for $l=0$	5.208
			36 for $l=1,2,..,6$	4.6875
	Extended CP	Δf=15 kHz	128 for $l=0,1,..,5$	16.667
Δf=7.5 kHz			248 for $l=0,1,2$	33.333
3 MHz	Normal CP	Δf=15 kHz	20 for $l=0$	5.208
			18 for $l=1,2,..,6$	4.6875
	Extended CP	Δf=15 kHz	64 for $l=0,1,..,5$	16.667
Δf=7.5 kHz			128 for $l=0,1,2$	33.333
1.4 MHz	Normal CP	Δf=15 kHz	10 for $l=0$	5.208
			9 for $l=1,2,..,6$	4.6875
	Extended CP	Δf=15 kHz	32 for $l=0,1,..,5$	16.667
Δf=7.5 kHz			64 for $l=0,1,2$	33.333

Appendix F - Motorola CDMA/EV-DO LMF

Motorola's CDMA/EV-DO base stations (BTS) are optimized with the assistance of Local Maintenance Facility (LMF), a Motorola's software tool that interfaces with the cell site and the instrument. The optimization process identifies the accumulated loss (or gain) for all receiving and transmitting paths at the cell site and stores that value in the system's database.

Using JD780A series LMF interface

An emulation interface to LMF has been implemented in JDSU's base station analyzer (JD785A) in order to perform BTS optimization procedures. The scope of this emulation is to do maintenance tests of TX Calibration and TX Audit required in routine maintenance practices with or without the use of an external power sensor. Using the external power sensor, you can get highly accurate measurement results.

Setting up for a LMF test

Procedure

1. To connect your instrument both with BTS and PC, do one of the following:
 - Internal power sensor: Connect the Motorola CDMA/EV-DO BTS with the Spectrum Analyzer RF In 50 Ω port of JD785A and connect the WinLMF running PC with JD785A via a hub as illustrated in the Figure 284.
 - External power sensor: Connect an external power sensor to the USB Host port of JD785A and to the BTS and connect the WinLMF running PC with JD785A via a hub as illustrated in the Figure 285.
-

Figure 284 Using internal power sensor

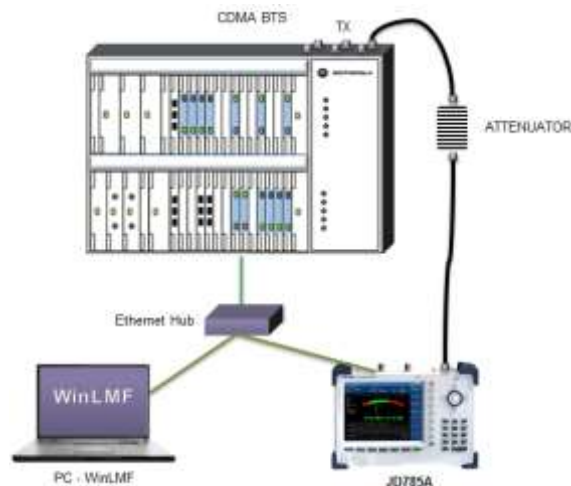
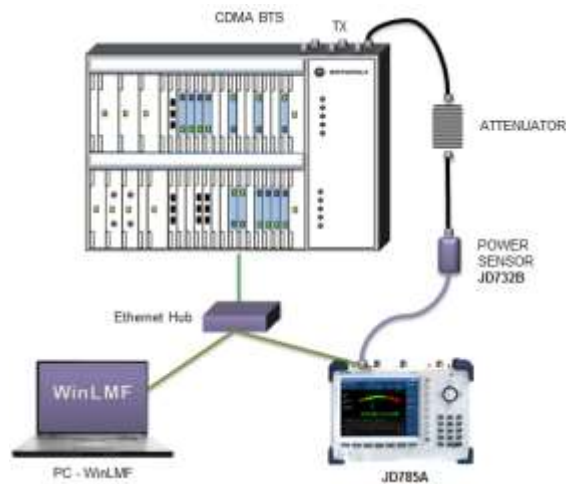

Figure 285 Using external power sensor



Performing a LMF test

Procedure

1. Press the **SYSTEM** hot key.
2. To set the IP address, complete the following steps:
 - a. Select **System Configuration > Ethernet Config**.
 - b. Toggle the **Mode** soft key and select **Static**.
 - c. Press the **Field > IP Address** soft key.
 - d. Set the IP address as "192.167.10.1".
3. Select **Remote Interface > LAN > LMF**.
4. To set up the LMF settings, complete the following steps:
 - a. Press the **LMF Settings** soft key.
 - b. Select the power measurement and BTS option from the following choices:
 - **External PM 800 MHz Band** for external measurement on cellular basestation
 - **External PM 1900 MHz Band** for external measurement on PCS basestation
 - **Internal PM 800 MHz Band** for internal measurement on cellular basestation
 - **Internal PM 1900 MHz Band** for internal measurement on PCS basestation
5. To select the measurement mode, complete the following steps:
 - a. Press the **MODE** hard key.
 - b. Press the **Power Meter** soft key.
 - c. Select **Internal RF Power Meter** or **External RF Power Meter** depending on your LMF settings. The measurement result is displayed on the screen.

Appendix G - Bluetooth connection

JD780A series' Bluetooth mode is used for communication between the instrument and your computer with JDRemote or a storage device in order to use the following services if needed.

- Bluetooth Personal Area Network (PAN) profile service for JDRemote.
- Bluetooth File Transfer Profile (FTP) or Object Push Profile (OPP) service for file transfer from the instrument to a Bluetooth storage device.

The Bluetooth Connectivity option includes a pair of Bluetooth USB Parani-UD100 Adapters and 5 dBi Dipole Antennas as well as the BlueSoleil application software.

Installing and Setting up Bluetooth software

The BlueSoleil application must be installed in your computer prior to making a Bluetooth connection. After installing the software, you must disable DHCP Server option in order to use the PAN service properly.

Procedure

1. Insert the provided CD-ROM into your computer and install the software as instructed. The BlueSoleil Space shortcut icon appears on the desktop.

NOTE

For more information on installation, refer to the Quick Start Guide or the User Guide provided with the adapter.

2. Double-click the **BlueSoleil Space** shortcut icon on your computer desktop to launch the application. The BlueSoleil program window appears.
3. Right-click the **My Device** icon (the orange ball) in the center of the window, and then click **Properties > Services** tab. The My Device Properties window appears.
4. Select the **Bluetooth Personal Area Network** from the list, and then click the **Properties** button. The Bluetooth Personal Area Network Properties window appears.
5. Click the **Options** tab, and then uncheck the **Enable DHCP Server** option.

NOTE

As the Enable DHCP Server option is checked by default, you must disable this option.

6. Click the **OK** button. The Bluetooth Personal Area Network Properties window dismisses.
 7. Click the **OK** button. The My Device Properties window dismisses.
-

Making Bluetooth connection

The JD780A series detects a connected Parani-UD100 USB Bluetooth Adapter automatically.

Procedure

1. Connect the 5 dBi Dipole Antenna to the Parani-UD100 Bluetooth USB Adapter: one for the computer and the other for JD780A series.
-

2. Plug in the Bluetooth adapters to the USB port of the computer and the instrument. The instrument detects the connected adapter and turns the Bluetooth mode on automatically. The Bluetooth icon appears in the status bar at the top of the instrument screen.
3. Double-click the **BlueSoleil Space** icon on the computer desktop to launch the application if not opened already. The BlueSoleil program window appears.
4. Double-click the **My Device** icon (orange ball) in the center of the application window to search the JD780A series. You can view an added icon around the orange ball labeled with the detected JD780A series' BD address or model and serial numbers.
5. Right-click the device icon for the JD780A series, and then click the **Pair**. The Bluetooth Passkey window appears.
6. Enter **0000** in the Passkey box, and then click the **OK** button. The word "Paired" appears on the window. The instrument also turns the Bluetooth Mode on automatically and displays the paired device and service information on the screen.
7. Double-click the device icon for the JD780A series to search services.
8. Right-click the icon for the JD780A series, and then select either the **Connect Bluetooth Personal Area Network** or the **Connect Bluetooth File Transfer**.

NOTE

Select one of these services as needed. If the Connect Bluetooth Personal Area Network is selected, a fixed IP address (192.168.10.10) is assigned for JD780A series and this address must be typed into the TCP/IP setting on JDViewer or JDRemote. See "Setting up communication in application" on page 549 for more information.

Setting up communication in application

If the Connect Bluetooth Personal Area Network service is selected on BlueSoleil, you need to configure communication setting on the application JDViewer or JDRemote by entering the fixed IP address for the instrument.

JDViewer setup

Procedure

1. Launch the JDViewer application.
 2. Go to **Settings > Communication**. The Settings dialog box appears.
 3. Click the drop-down list in the Instrument pane, and then select the instrument series to be communicated.
 4. In the Connection Method pane, select the **TCP/IP**, and then enter **192.168.10.10** without dots.
 5. Click **OK** to finish the communication setup.
 6. Go to **Load > Connect** to make a connection between the instrument and JDViewer. JD780A series and JDViewer become ready for communication.
-

JDRemote setup

Procedure

1. Launch the JDRemote application. The Select Model dialog box appears.
-

2. Select the **740A, 780A Series**, and then click the **OK** button.
 3. Right-click on the JDRemote window, and then click the **Communication**.
The Communication dialog box appears.
 4. Select the **TCP/IP**, and then enter **192.168.10.10** without dots.
 5. Click **OK** to finish the communication setup.
 6. Right-click on the JDRemote window, and then click the **Connect**.
This enables communication between the instrument and JDRemote.
 7. Right-click on the JDRemote window, and then click the **Start**.
JD780A series and JDRemote become ready for communication.
 8. *Optional.* To adjust the image quality, complete the following steps:
 - a. Right-click on the JDRemote.
 - b. Click the **Quality**.
 - c. Select the image quality option among **High, Medium, or Low**.
You can improve refresh rate, if experiencing low-quality signal, by adjusting the image quality in JDRemote.
-

Turning Bluetooth mode on/off manually

JD780A series turns the Bluetooth Mode on automatically if connected. You can also turn it on and off manually.

Procedure

1. Press the **SYSTEM** hot key.
 2. Press the **System Configuration > Remote Interface > Bluetooth** soft key.
The Bluetooth screen appears with the device information.
 3. Toggle the **Bluetooth** soft key between **On** and **Off** to turn it on and off.
Connecting or disconnecting the adapter also turns the mode on or off automatically.
-

Appendix H - Device driver installation

JD780A series can be controlled from the application software JDViewer or JDRemote installed on your computer. You must install driver software for the instrument on to the computer if USB Client connection is used for communication.

Procedure

1. Go to **Control Panel > System > Device Manager**.
The Device Manager window appears.
2. Right-click the **Unknown Device** under the **Other Devices**, and then click the **Update Driver Software**.
The Update Driver Software – Unknown Device window appears as shown in the **Figure 286** below.
3. Select the **Browse my computer for driver software**, and then click the **Browse** button to search for the location where the driver software is.
The Browse For Folder window appears.
4. Search for the **JDRemote** folder, and then select the driver folder for the installed OS.
For example, OSDisk (C:) > Program Files (x86) > JDRemote > Driver > Win7 > 64bit.
5. Click the **OK** button.
The Browse For Folder window dismisses.
6. Click the **Next** button to start installation.
If the Windows Security window appears, select the **Install this driver software anyway**.
Installing driver software starts.
7. Click the **Close** button at the end of the installation.

Figure 286 Device manager screen

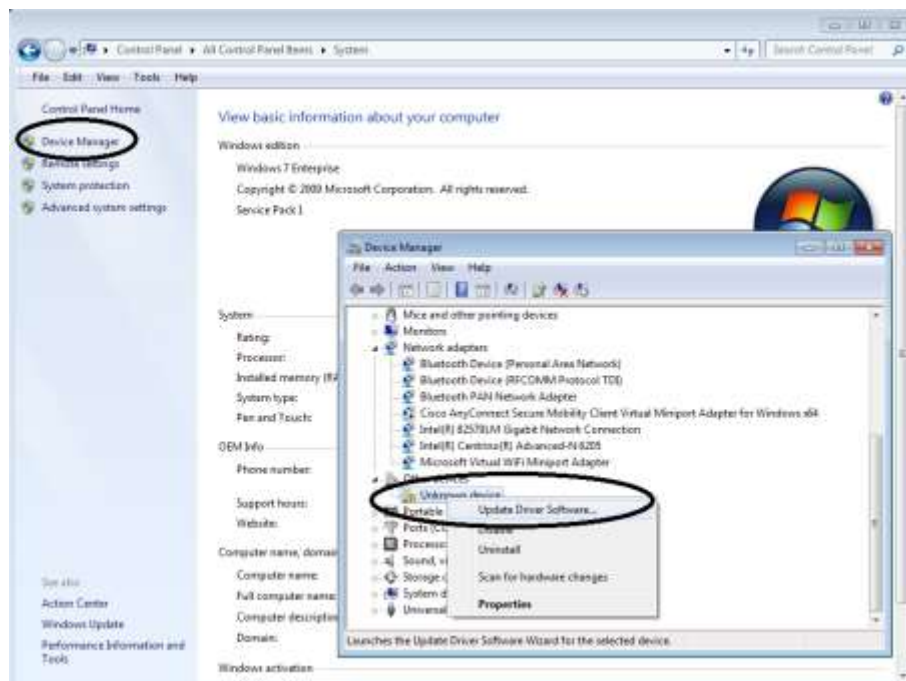

Appendix I - Ordering information

JD785A Base Station Analyzer

JD785A

9 kHz to 8 GHz	Spectrum Analyzer	
5 MHz to 6 GHz	Cable and Antenna Analyzer ¹	
10 MHz to 8 GHz	RF Power Meter	Internal mode

Options

NOTE: Upgrade options for the JD785A use the designation JD785AU before the respective last three-digit option number.

JD785A001	2-Port Transmission Measurements ²	
JD785A002	Bias Tee	(Requires option 01)
JD785A003	CW Signal Generator	
JD785A004	E1 Analyzer ³	
JD785A005	T1 Analyzer ³	
JD785A006	Bluetooth Connectivity	
JD785A010	GPS Receiver and Antenna	
JD785A011	Interference Analyzer ^{4,5}	
JD785A012	Channel Scanner	
JD785A020	cdmaOne/cdma2000 Signal Analyzer	
JD785A021	EV-DO Signal Analyzer	(Requires option 20)
JD785A022	GSM/GPRS/EDGE Signal Analyzer	
JD785A023	WCDMA/HSPA+ Signal Analyzer	
JD785A025	TD-SCDMA Signal Analyzer	
JD785A026	Mobile WiMAX Signal Analyzer	
JD785A028	LTE-FDD Signal Analyzer	
JD785A029	LTE-TDD Signal Analyzer	
JD785A030	LTE Advanced-FDD Signal Analyzer	(Requires option 28)
JD785A031	LTE Advanced-TDD Signal Analyzer	(Requires option 29)
JD785A040	cdmaOne/cdma2000 OTA Analyzer ⁵	(Requires option 10)
JD785A041	EV-DO OTA Analyzer ⁵	(Requires option 10)
JD785A042	GSM/GPRS/EDGE OTA Analyzer ⁵	(Requires option 10)
JD785A043	WCDMA/HSPA+ OTA Analyzer ⁵	(Requires option 10)
JD785A045	TD-SCDMA OTA Analyzer ⁵	(Requires option 10)
JD785A046	Mobile WiMAX OTA Analyzer ⁵	(Requires option 10)
JD785A048	LTE-FDD OTA Analyzer ⁵	(Requires option 10)
JD785A049	LTE-TDD OTA Analyzer ⁵	(Requires option 10)

Standard Accessories

G710550326	AC/DC Power Adapter ⁶
G710550335	Cross LAN Cable (1.5 m) ⁶
GC73050515	USB A to B Cable (1.8 m) ⁶
GC72450518	> 1 G Byte USB Memory ⁶
G710550325	Rechargeable Lithium Ion Battery ⁶
G710550323	Automotive Cigarette Lighter 12 V DC Adapter ⁶
G710550316	Stylus Pen ⁶
JD780A361	JD780A Series User's Manual and Application Software – CD

¹Requires Calibration Kit

²Requires Dual Port Calibration Kit

³Requires Test Cable

⁴Highly recommended adding JD785A010

⁵Highly recommended adding G70005035x and/or G70005036x

⁶Standard accessories can be purchased separately.

JD786A RF Analyzer

JD786A

9 kHz to 8 GHz	Spectrum Analyzer	
5 MHz to 6 GHz	Cable and Antenna Analyzer ¹	
10 MHz to 8 GHz	RF Power Meter	Internal mode

Options

NOTE: Upgrade options for the JD786A use the designation JD786AU before the respective last three-digit option number.

JD786A001	2-Port Transmission Measurements ²	
JD786A002	Bias Tee	(Requires option 01)
JD786A003	CW Signal Generator	
JD786A010	GPS Receiver and Antenna	
JD786A011	Interference Analyzer ^{3,4}	
JD786A012	Channel Scanner	

Standard Accessories

G710550326	AC/DC Power Adapter ⁵
G710550335	Cross LAN Cable (1.5 m) ⁵
GC73050515	USB A to B Cable (1.8 m) ⁵
GC72450518	> 1 G Byte USB Memory ⁵
G710550325	Rechargeable Lithium Ion Battery ⁵
G710550323	Automotive Cigarette Lighter 12 V DC Adapter ⁵
G710550316	Stylus Pen ⁵
JD780A361	JD780A Series User's Manual and Application Software – CD

¹Requires Calibration Kit

²Requires Dual port Calibration Kit

³Highly recommended adding JD786A010

⁴Highly recommended adding G70005035x and/or G70005036x

⁵Standard accessories can be purchased separately.

JD788A Signal Analyzer

JD788A

9 kHz to 8 GHz	Spectrum Analyzer	
10 MHz to 8 GHz	RF Power Meter	Internal mode

Options

NOTE: Upgrade options for the JD788A use the designation JD788AU before the respective last three-digit option number.

JD785A001	2-Port Transmission Measurements ¹	
JD785A003	CW Signal Generator	
JD788A006	Bluetooth Connectivity	
JD788A009	20 MHz Demodulation Hardware	
JD788A010	GPS Receiver and Antenna	
JD788A011	Interference Analyzer ^{2,3}	
JD788A012	Channel Scanner	
JD788A020	cdmaOne/cdma2000 Signal Analyzer	(Requires option 9)
JD788A021	EV-DO Signal Analyzer	(Requires option 9 and 20)
JD788A022	GSM/GPRS/EDGE Signal Analyzer	(Requires option 9)
JD788A023	WCDMA/HSPA+ Signal Analyzer	(Requires option 9)
JD788A025	TD-SCDMA Signal Analyzer	(Requires option 9)
JD788A026	Mobile WiMAX Signal Analyzer	(Requires option 9)
JD788A028	LTE-FDD Signal Analyzer	(Requires option 9)
JD788A029	LTE-TDD Signal Analyzer	(Requires option 9)
JD788A030	LTE Advanced-FDD Signal Analyzer	(Requires options 9 and 28)
JD788A031	LTE Advanced-TDD Signal Analyzer	(Requires options 9 and 29)
JD788A040	cdmaOne/cdma2000 OTA Analyzer ³	(Requires options 9 and 10)
JD788A041	EV-DO OTA Analyzer ³	(Requires options 9 and 10)
JD788A042	GSM/GPRS/EDGE OTA Analyzer ³	(Requires options 9 and 10)
JD788A043	WCDMA/HSPA+ OTA Analyzer ³	(Requires options 9 and 10)
JD788A045	TD-SCDMA OTA Analyzer ³	(Requires options 9 and 10)
JD788A046	Mobile WiMAX OTA Analyzer ³	(Requires options 9 and 10)
JD788A048	LTE-FDD OTA Analyzer ³	(Requires options 9 and 10)
JD788A049	LTE-TDD OTA Analyzer ³	(Requires options 9 and 10)

Standard Accessories

G710550326	AC/DC Power Adapter ⁴
G710550335	Cross LAN Cable (1.5 m) ⁴
GC73050515	USB A to B Cable (1.8 m) ⁴
GC72450518	> 1 G Byte USB Memory ⁴
G710550325	Rechargeable Lithium Ion Battery ⁴
G710550323	Automotive Cigarette Lighter 12 V DC Adapter ⁴
G710550316	Stylus Pen ⁴
JD780A361	JD780A Series User's Manual and Application Software – CD

¹Requires Dual Port Calibration Kit

²Highly recommended adding JD788A010

³Highly recommended adding G70005035x and/or G70005036x

⁴Standard accessories can be purchased separately.

JD780A Series Common Options

Optional RF Power Sensors

JD731B	Directional Power Sensor (peak and average power) Frequency: 300 MHz to 3.8 GHz Power: Average 0.15 to 150 W, Peak 4 to 400 W
JD733A	Directional Power Sensor (peak and average power) Frequency: 150 MHz to 3.5 GHz Power: Average/Peak 0.1 to 50 W
JD732B	Terminating Power Sensor (average power) Frequency: 20 MHz to 3.8 GHz Power: -30 to +20 dBm
JD734B	Terminating Power Sensor (peak power) Frequency: 20 MHz to 3.8 GHz Power: -30 to +20 dBm
JD736B	Terminating Power Sensor (peak and average power) Frequency: 20 MHz to 3.8 GHz Power: -30 to +20 dBm

Optional Optical Power Sensors

MP-60A	USB Optical Power Meter, with software, 2.5 mm and 1.25 mm interfaces, 30" USB extender, carrying pouch
MP-80A	USB Optical Power Meter-High Power, with software, 2.5 mm and 1.25 mm interfaces, 30" USB extender, carrying pouch

Optional Calibration Kits

JD72450509	Y - Calibration Kit, Type-N(m), DC to 6 GHz, 50 Ω
JD71050507	Dual Port Type-N Calibration Kit, 50 Ω <ul style="list-style-type: none"> - Y - Calibration Kit, Type-N(m), DC to 6 GHz, 50 Ω - Two Adapters Type-N(f) to Type-N(f), DC to 6 GHz, 50 Ω - Two 1 m RF Test Cables, Type-N(m) to Type-N(m), DC to 18 GHz, 50 Ω

Optional Fiber Microscope Kits

FBP-SD101	FBP-P5000i Digital Probe, FiberChekPRO SW, Case, and Tips (FBPT-SC, FBPT-LC, FBPT-U25M, FBPT-U12M)
FBP-MTS-101	FBP-P5000i Digital Probe, FiberChekPRO SW, Case, and Tips (FBPT-SC, FBPT-SC/APC, FBPT-FC, FBPT-LC, FBPT-U25M, FBPT-U25MA, FBPT-U12M)
FIT-SD103	FBP-P5000i Digital Probe, MP-60 USB Power Meter, FiberChekPRO SW, Case, Tips and Adapters (FBPT-SC, FBPT-LC, FBPT-U25M, FBPT-U12M)
FIT-SD103-C	FBP-P5000i Digital Probe, MP-60 USB Power Meter, FiberChekPRO SW, Case, Tips and Adapters (FBPT-SC, FBPT-LC, FBPT-U25M, FBPT-U12M), Cleaning Materials
FIT-SD113	FBP-P5000i Digital Probe, MP-60 USB Power Meter, FiberChekPRO SW, Case, Tips and Adapters (FBPT-SC, FBPT-LC, FBPT-U25M, FBPT-U12M)

Optional RF Cables

G710050530	1.0 m (3.28 ft) RF Cable, DC to 18 GHz, Type-N(m) to Type-N(m), 50 Ω
G710050531	1.5 m (4.92 ft) RF Cable, DC to 18 GHz, Type-N(m) to Type-N(f), 50 Ω
G710050532	3.0 m (9.84 ft) RF Cable, DC to 18 GHz, Type-N(m) to Type-N(f), 50 Ω
G710050533	1.5 m (4.92 ft) RF Cable, DC to 18 GHz, Type-N(m) to SMA(m), 50 Ω
G710050534	1.5 m (4.92 ft) RF Cable, DC to 18 GHz, Type-N(m) to QMA(m), 50 Ω
G710050535	1.5 m (4.92 ft) RF Cable, DC to 18 GHz, Type-N(m) to SMB(m), 50 Ω

Optional Omni Antennas

G700050353	RF Omni Antenna	Type-N(m), 806 MHz to 896 MHz
G700050354	RF Omni Antenna	Type-N(m), 870 MHz to 960 MHz
G700050355	RF Omni Antenna	Type-N(m), 1.71 GHz to 2.17 GHz
G700050356	RF Omni Antenna	Type-N(m), 720 MHz to 800 MHz
G700050357	RF Omni Antenna	Type-N(m), 2.3 GHz to 2.7 GHz

Optional Yagi Antennas

G700050364	RF Yagi Antenna	Type-N(f), 806 MHz to 896 MHz, 10.2 dBd
G700050365	RF Yagi Antenna	Type-N(f), 866 MHz to 960 MHz, 10.2 dBd
G700050363	RF Yagi Antenna	Type-N(f), 1.75 GHz to 2.39 GHz, 9.8 dBd
G700050366	RF Yagi Antenna	SMA(f), 700 MHz to 4 GHz, 1.85 dBd

Optional RF Adapters

G710050570	Adapter Type-N(f) to Type-N(f), DC to 6 GHz, 50 Ω
G710050571	Adapter Type-N(m) to DIN(f), DC to 4 GHz, 50 Ω
G710050572	Adapter DIN(m) to DIN(m), DC to 4 GHz, 50 Ω
G710050573	Adapter Type-N(m) to SMA(f), DC to 18 GHz, 50 Ω
G710050574	Adapter Type-N(m) to BNC(f), DC to 1.5 GHz, 50 Ω
G710050575	Adapter Type-N(f) to Type-N(f), DC to 4 GHz, 50 Ω
G710050576	Adapter Type-N(m) to DIN(m), DC to 4 GHz, 50 Ω
G710050577	Adapter Type-N(f) to DIN(f), DC to 4 GHz, 50 Ω
G710050578	Adapter Type-N(f) to DIN(m), DC to 4 GHz, 50 Ω
G710050579	Adapter DIN(f) to DIN(f), DC to 4 GHz, 50 Ω

Optional E1/T1 Test Cables

G710050317	RJ45 to Y Bantam Cable
G710050318	RJ45 to Y BNC Cable
G710050319	RJ45 to 4 Alligator Clips

StrataSync Subscription

STRATASYNC-AM-CA-SA-1Yr	StrataSync Asset Management Annual Subscription
STRATASYNC-TDM-CA-SA-1Yr	StrataSync Test Data Management Annual Subscription ¹

¹ Requires STRATASYNC-AM-CA-SA-1Yr

Optional Miscellaneous

G710050581	Attenuator 40 dB, 100 W, DC to 4 GHz (Unidirectional)
JD74050341	Soft Carrying Case
JD71050342	Hard Carrying Case
JD70050342	Hard Carrying Case with wheels
JD70050343	CellAdvisor Backpack Carrying Case
JD70050006	USB Bluetooth Dongle and 5 dBi Dipole Antenna
G710050585	RF Directional Coupler, 700 MHz to 4 GHz, 30 dB, Input/Output; Type-N(m) to Type-N(f), Tap Off; Type-N(f) ²
G710050586	RF Combiner, 700 MHz to 4 GHz, Type-N(f) to Type-N(m) ²
G710050587	4x1 RF Combiner, 700 MHz to 4 GHz, Type-N(f) to Type-N(m) ³
G710550324	External Battery Charger
JD780A362	JD785A Series User’s Manual – Printed Version

²Highly recommended for LTE Testing

³Highly recommended for LTE Advanced Testing

Appendix J - RoHS information

This appendix describes the RoHS (Restriction of Hazardous Substances) information, which is a mandatory requirement from China. The RoHS directive consists in the restriction on the use of certain hazardous substances in electrical or electronic equipment sold or used in the European Union, after July 1, 2006. These substances are: lead, mercury, cadmium, hexavalent chromium, polybrominated biphenyls, and polybrominated diphenyl ethers.

Concerned Products: JD785A, JD786A, JD788A

“中国 RoHS”

《电子信息产品污染控制管理办法》（信息产业部，第 39 号）

附录 (Additional Information required for the Chinese Market only)

本附录按照“中国 RoHS”的要求说明了有关电子信息产品环保使用期限的情况，并列出了产品中含有的有毒、有害物质的种类和所在部件。本附录适用于产品主体和所有配件。

产品系列: JD780A

(Product Family)

环保使用期限:



本标识标注于产品主体之上，表明该产品或其配件含有有毒、有害物质（详情见下表）。

其中的数字代表在正常操作条件下至少在产品生产日期之后数年内该产品或其配件内含有的有毒、有害物质不会变异或泄漏。该期限不适用于诸如电池等易耗品。

有关正常操作条件，请参见产品用户手册。

产品生产日期请参见产品的原始校准证书。

有毒、有害物质的类型和所在部件

元器件 (Component)	有毒、有害物质和元素					
	铅(Pb)	汞(Hg)	镉(Cd)	六价铬(CR ⁶⁺)	多溴联苯(PBB)	多溴二苯醚(PBDE)
产品主体 (Main Product)						
印刷电路板组件 (PCB Assemblies)	X	O	O	O	O	O
内部配线 (Internal wiring)	O	O	O	O	O	O
显示器 (Display)	O	O	O	O	O	O
键盘 (Keypad)	O	O	O	O	O	O
电池 (Batteries)	O	O	O	O	O	O
电工零件 (Electro-mechanical parts)	O	O	O	O	O	O
金属外壳零件和紧固件 (Metal case parts and fixings)	O	O	O	O	O	O
塑料外壳零件 (Plastic case parts)	O	O	O	O	O	O
标签和胶带 (Labels and tapes)	O	O	O	O	O	O
配件 (Accessories)						
外接电缆和适配器 (External cables and adapters)	X	O	O	O	X	X
USB 记忆 (USB Memory)	X	O	O	O	O	O
手册和其它印刷材料 (Handbooks and other printed material)	O	O	O	O	O	O
包装箱和绑带 (Carrying case and strap)	O	O	O	O	O	O
其它配件 (Other accessories)	X	O	O	O	X	X
AC/DC 电源适配器 (AC/DC Power Adapters)	O	O	O	O	O	O

O: 代表该部分中所有均质材料含有的该有毒、有害物质含量低于 SJ/T11363-2006 标准的限值。
X: 代表该部分中所有均质材料含有的该有毒、有害物质含量高于 SJ/T11363-2006 标准的限值。

Appendix K - On-screen keyboard

You can use the on-screen keyboard to type in texts, file names, and folder names.

Adding or deleting letters

Procedure

1. Tap keys on the on-screen keyboard. As you type, each letter is displayed in the name field. If you want to change the letter case between uppercase and lowercase, tap the **Caps** key.
2. To delete a letter, tap the **Back** key on the keyboard or press the backspace key on the keypad.
3. To move the cursor along the name field, tap the < or > key, turn the rotary knob, or touch in between letters in the name field.
4. To delete all the letters displayed in the name field, tap the **Clear** key on the on-screen keyboard.

Figure 287 On-screen keyboard



Editing or adding a custom keyword

You can edit and delete a keyword or add a new one, as you desire.

Procedure

1. Tap the **Edit Keywords** bar on the on-screen keyboard. The edit keywords keyboard appears.
2. To edit a keyword, select the keyword box and then change the letters.
3. To delete a keyword, select the keyword box and then tap the **Clear** key.
4. To add a keyword, select a blank keyword box and then type in a keyword.
5. Tap the **Save** key on the keyboard to save and continue saving.

Figure 288 Edit keywords keyboard

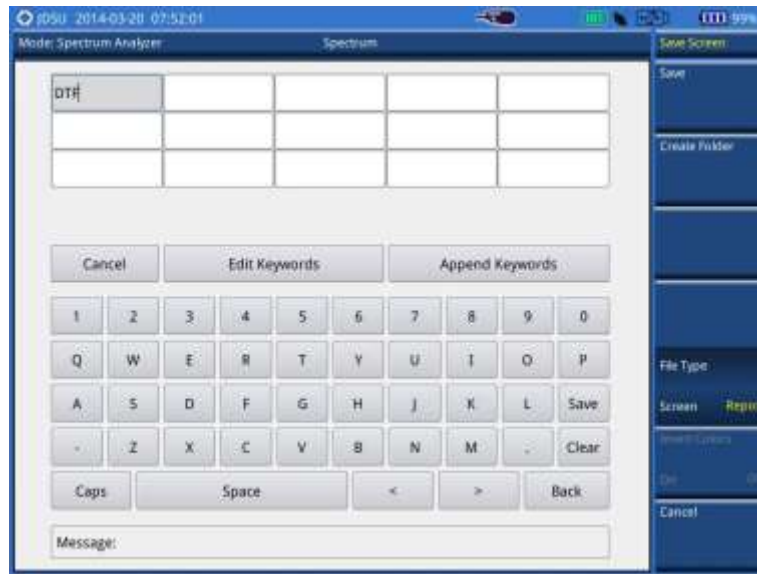

Appending a keyword

You can append a factory-stored or custom-defined keyword, as you want.

Procedure

1. Tap the **Append Keywords** bar on the on-screen keyboard. The append keywords window appears.
2. To append a keyword, complete the following steps:
 - a. Select the keyword tag button to view available keywords for the tag.
 - b. Select one keyword, from the following choices for each keyword tag:

Keyword tag	Keyword (tag value)
Site-ID*	SiteA, SiteB, and SiteC
Sector*	Alpha, Beta, and Gamma
Technology*	GSM900, WCDMA850, and LTE180
Test Type*	RL, VSWR, DTF-RL, DTF-VSWR, and CL
Termination*	Open, Load, and Antenna
Custom	Any keywords you have added

- c. To delete the keyword you have added to the keyword field, tap the **Delete** button.
 - d. To clear the keyword field, tap the **Clear** button.
3. *Optional.* You can edit any of the custom keyword tags or tag values by tapping the **Edit Tags Values** or **Edit Tags** button, but not the factory keyword tags marked with the asterisk (*).

NOTE

You must keep the keywords marked with the asterisk (*) intact as the StrataSync server uses them when transferring data.

4. Select the **Separator** option from the choices: hyphen [-], underscore [_], or **None**.
5. Select the **As a filename** option between **On** and **Off**. If you select **Off**, the keyword will not be placed in a file name, but in the trace/PNG file information.
6. Tap the **Save and Exit** button to save and exit or the **Keyboard** button to return to the keyboard.

Figure 289 Append keywords window

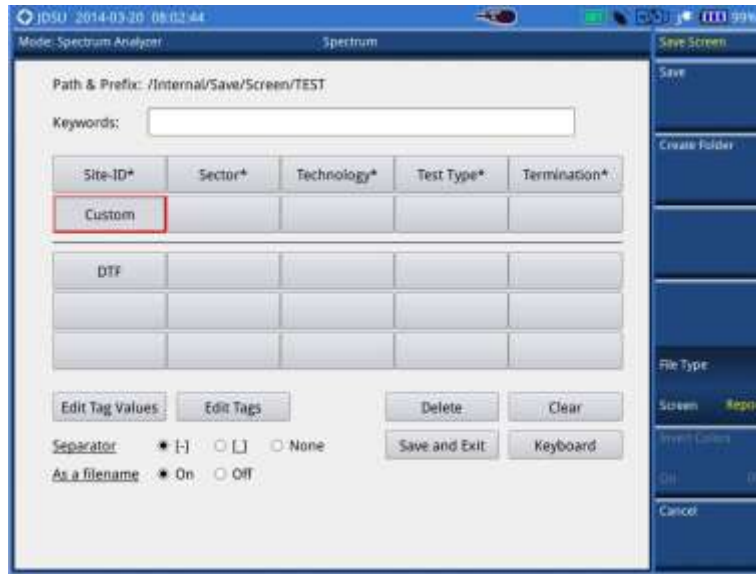



Network and Service Enablement Regional Sales

North America
Toll Free: 1 855 ASK JDSU
Tel: +1 240 404 2999
Fax: +1 240 404 2195

Latin America
Tel: +55 11 5503 3800
Fax: +55 11 5505 1598

Asia Pacific
Tel: +852 2892 0990
Fax: +852 2892 0770

EMEA
Tel: +49 7121 86 2222
Fax: +49 7121 86 1222

www.jdsu.com

Rev. 3.1, April 2014
<English>