

July 2021



VIAMI Solutions

OneExpert CATV 630

Extended Quick Start Guide v 5.5

Table of Contents

- OneExpert CATV Overview
 - Battery Replacement
 - RF Barrel and Collar Replacement
 - Remote Access
 - Engineering Mode
 - Home Screen
 - Utility Menu
 - System Settings
 - CATV Settings
- Software and Firmware Upgrades
 - USB Firmware Upgrades
 - StrataSync Firmware Upgrade
 - Firmware Recovery
- Synchronization with StrataSync
 - Ethernet
 - WIFI
 - RF Sync
- Mobile Tech App
- Ethernet Testing
 - Speedcheck
 - TrueSpeed
- Wiring Tools
 - Port Discovery
 - Hub Flash
 - Ping Tool

Table of Contents

- Fiber Optics Tools
 - P5000i Inspection Scope
- MP60/80A USB Power MeterFiber Optics Tools
 - P5000i Inspection Scope
 - MP60/80A USB Power Meter
- CATV Measurements
 - Quick Check
 - Spectrum
 - TDR
 - HL Leakage Option and Transmitter
 - Ingress Scan
 - Channel Check
 - DOCSIS Check
 - One CHECK
- DOCSIS EXPERT
- Ingress EXPERT
- OneCheck EXPERT
- Return Signal Generator (RSG) w/ Loopback
- Field View with RSG
- Forward Sweep
- Return Sweep
- Sweepless Sweep
- Return Sweepless Sweep
- Qam Video Option
- Sweep Errors

Support Links

Viavi Customer Care:

For questions about warranty information, repair and calibration, Return Material Authorization (RMA) request, services quotation, order status.

T: 1-844 GO VIAVI (+1-844-468-4284)

E: NAM.CustomerCare@viavisolutions.com

<https://www.viavisolutions.com/en-us/services-and-support/support-center/customer-care>

Customer Care Portal Login

<https://www.viavisolutions.com/en-us/services-and-support/support-center/customer-care/customer-portal-login>

RMA Request Form:

<http://www.viavisolutions.com/en-us/services-and-support/return-material-authorization-rma-request>

Viavi Technical Support:

Will assist you in using/configuring products or address issues regarding product performance.

T: +1-844 GO VIAVI (+1-844-468-4284)

E: catvsupport@viavisolutions.com

For access to online technical and product support:

<http://support.viavisolutions.com>

Quick Tip Videos:

<https://www.viavisolutions.com/en-us/support/quick-references/quick-tip-videos>

Product Focused YouTube Channel:

[ViaviSolutions CIVT](#)

Interactive ONX Videos

<https://xpertinstruction.com>

OneExpert CATV Overview

Table of Contents

- Fiber Optics Tools
 - P5000i Inspection Scope
 - MP60/80A USB Power Meter
- CATV Measurements
 - Quick Check
 - Spectrum
 - TDR
 - HL Leakage Option and Transmitter
 - Ingress Scan
 - Channel Check
 - DOCSIS Check
 - One CHECK

Support Links

Viavi Customer Care:

For questions about warranty information, repair and calibration, Return Material Authorization (RMA) request, services quotation, order status.

T: 1-844 GO VIAVI (+1-844-468-4284)

E: NAM.CustomerCare@viavisolutions.com

<https://www.viavisolutions.com/en-us/services-and-support/support-center/customer-care>

Customer Care Portal Login

<https://www.viavisolutions.com/en-us/services-and-support/support-center/customer-care/customer-portal-login>

RMA Request Form:

<http://www.viavisolutions.com/en-us/services-and-support/return-material-authorization-rma-request>

Viavi Technical Support:

Will assist you in using/configuring products or address issues regarding product performance.

T: +1-844 GO VIAVI (+1-844-468-4284)

E: catvsupport@viavisolutions.com

For access to online technical and product support:

<http://support.viavisolutions.com>

Quick Tip Videos:

<https://www.viavisolutions.com/en-us/support/quick-references/quick-tip-videos>

Product Focused YouTube Channel:

[ViaviSolutions CIVT](#)

OneExpert CATV Overview

OneExpert CATV Interfaces

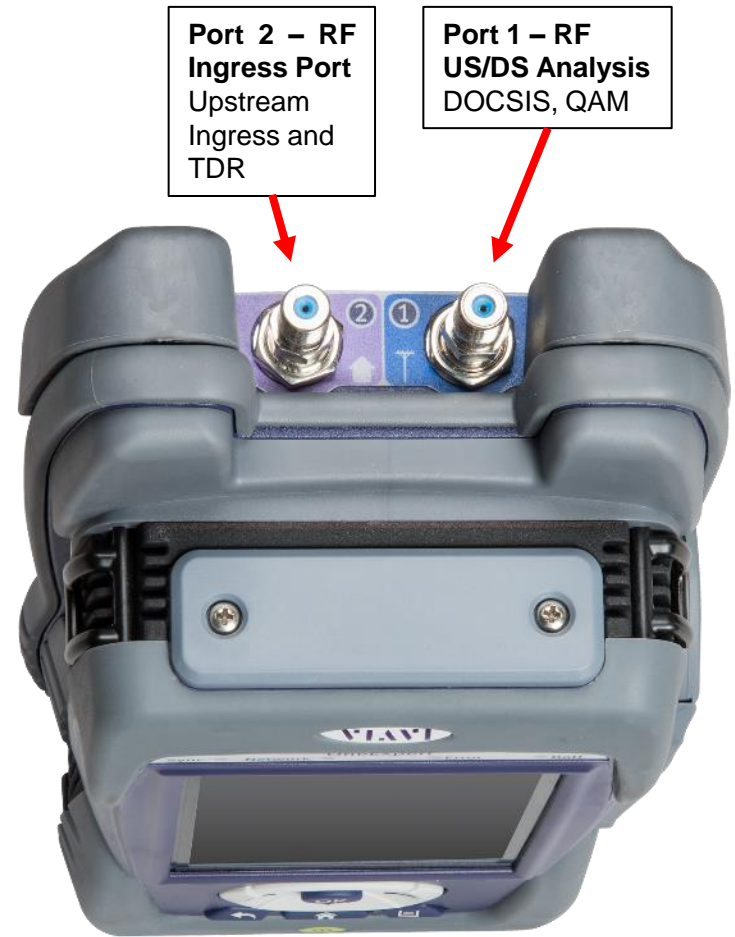
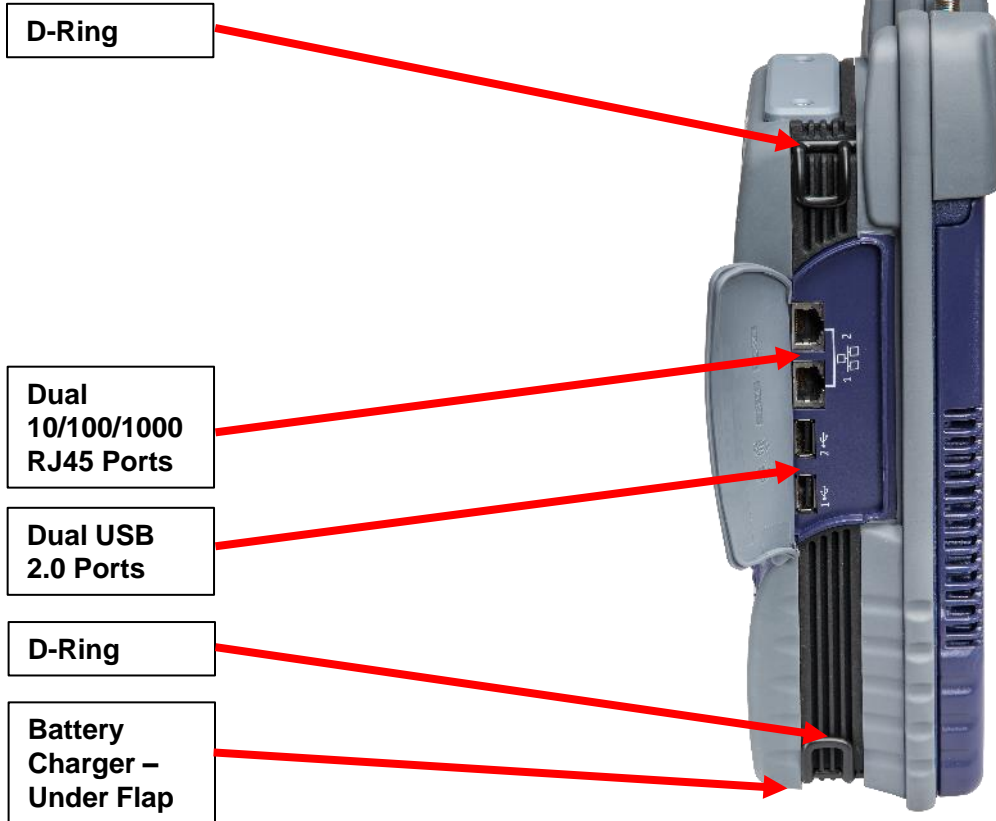

OneExpert CATV Controls



AC CHARGER PORT

- **SOLID GREEN** indicates that charging is complete.
- **SLOW FLASHING RED** indicates that the battery charge is critically low, and less than 10%
- **FAST FLASHING RED** indicates that the charging was suspended due to a fault and user intervention is necessary (for example, an incorrect charger is attached)
- **SOLID RED** indicates that the charging was suspended due to overheating
- **SOLID AMBER** indicates that the battery is charging



NETWORK INDICATOR and BATTERY LEDs

LCD Screen

SHORTCUT/SOFT KEYS

DIRECTIONAL Pad

BACK, HOME and UTILITY Buttons

POWER O/I Button

Battery Replacement

Removing and Replacing Battery

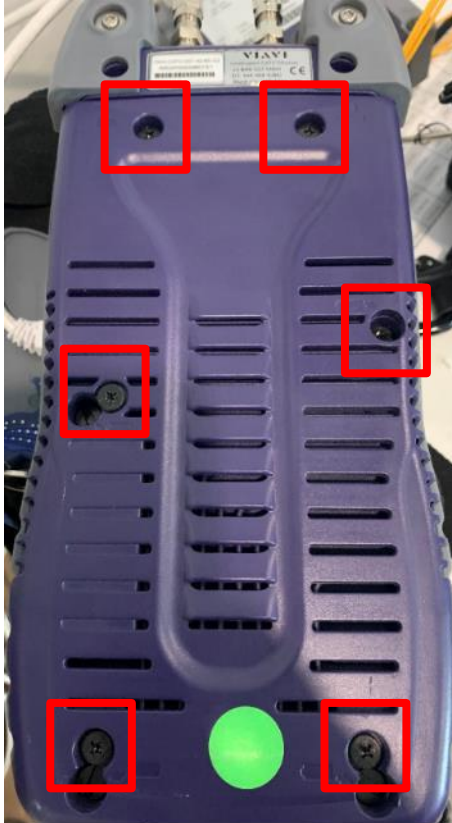

Remove OneExpert CATV cloth case and locate the 6 flat-head screws marked with the battery icon

Loosen each screw with a standard slotted screwdriver until they disengage from the MAINFRAME portion of the unit

Note that these 6 screws are designed to remain captive with the MODULE.

Removing the Module will expose a backplane connector that extends from the Mainframe. There is risk of damaging this backplane connector if the unit is pulled apart without exercising the proper caution.

A single screw hold the battery compartment lid in place

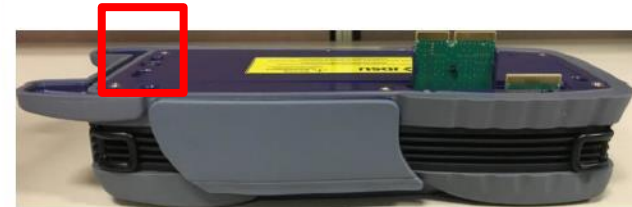

Removing and Replacing Battery



RF Barrel and Collar Replacement

OneExpert CATV RF Ports F-81 Adapter Barrel Style Connector



The ONX-CATV has two RF ports with field replaceable barrel style connectors. The ONX ships with two F- 81 splice style adapters rated to 3 GHz. These F-81 adapters are 1.2 in (307mm) long with a 0.5 in (132mm) distance between either end and the tightening nut. They are shipped installed into the RF ports to the recommended torque specification of 20 in-lbs. (1.6 ft-lbs.).

After some use these F-81 adapters may need to be replaced. When replacing these adapters, an F-81 adapter with similar dimensions and specifications is recommended.

Reason for RF Port Aluminum Collars and F-81 Considerations

Since early 2017 all ONX models are built with aluminum collars around the RF port F-81 barrel-connectors. These collars were added to provide additional mechanical protection from lateral forces which could break the F connector and/or the RF port on the ONX. These collars work by reinforcing the base of the connector and help distribute forces over a bigger area. The height of the collar accommodates the F-81 barrel-connector that was originally shipped with the ONX, but has some margin to accommodate other, similarly sized and rated, F-81 barrel-connectors.

It is important to ensure that ONX RF port F-81 barrel-connector replacements have enough length to pass through the aluminum collar and screw in far enough to close any gaps. Seating the connector properly into the ONX RF port prevents off-air signals from leaking around the F-81 barrel-connector. Also, the F-81 barrel-connector used should not be so long that when tightened it leaves a loose collar. The reinforcing strength provided by the collar requires the collar to be firmly held in place by the F-81 barrel-connector inserted into the ONX's RF ports. A loose collar will not properly strengthen the F-81 barrel-connector, making it more susceptible to breaking when stressed.



ONX-CATV's RF port aluminum collars



RF ports with collars between the F-81 barrel-connectors and ONX body

Replacing the F Connector



F-81 barrel-connectors come in many different forms based on their intended application. The ONX uses an F-81 splice style F connector, like the one shown here on the far-left. It is recommended that replacement F connectors be of similar length to minimize any negative impacts.



Start by removing the current F-81 adapter and collar (if present). If needed use a 7/16 wrench, turn the F connector counterclockwise until the adapter is completely out of the ONX RF port. Retain the collars if not replacing them with new ones.

Place the new F-81 adapter through the collar and screw the adapter into the ONX RF Port by turning clockwise. Make sure the collar is between the ONX and the F connector nut, as shown in the picture below. Tightening the F-81 adapter into the RF port to the torque specification of 20 in-lbs. (1.6 ft-lbs.) is recommended, which is about hand tight plus another quarter turn.

WARNING: Do NOT overtighten the F-81 adapter into the ONX's RF port, this can lead to permanently broken RF ports. Also, it is not recommended to use power tools when removing or replacing the F-81 adapters.

Remote Access

Remote Access

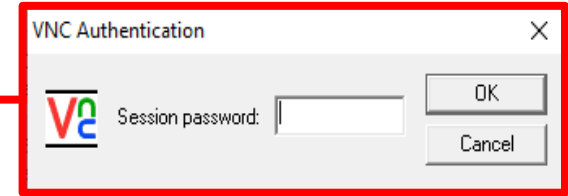
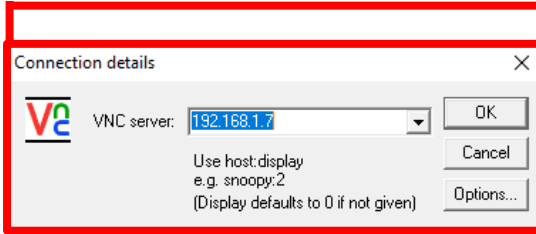
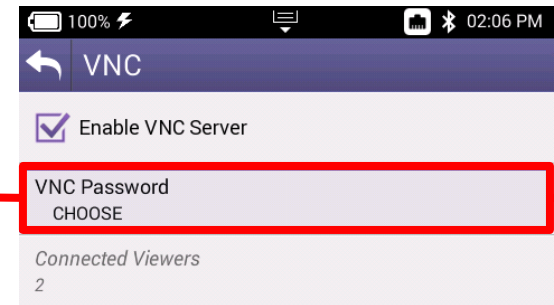
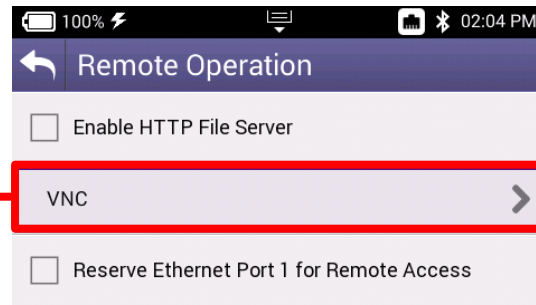
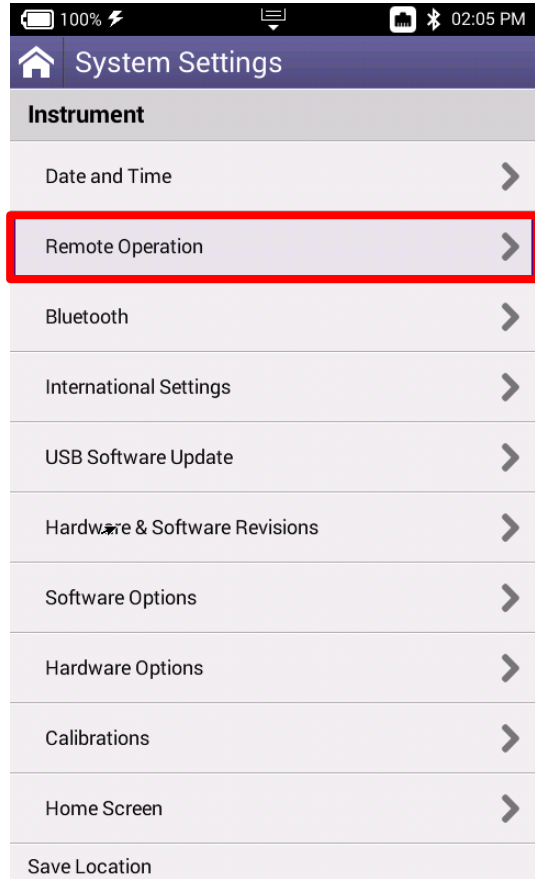

Engineering Mode

Engineering Mode



Hold UTILITY KEY simultaneously during POWER button press. Continue to hold UTILITY KEY until LEDs flash ORANGE, then release UTILITY KEY

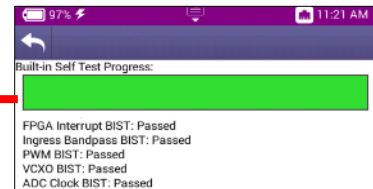
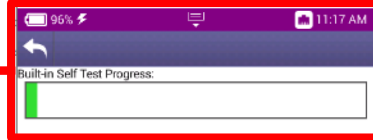
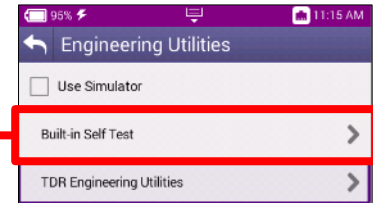
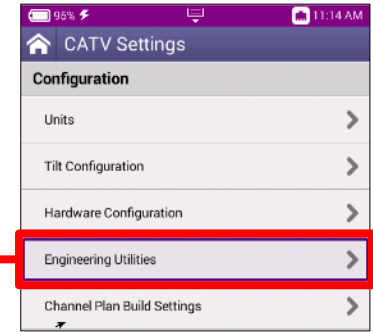
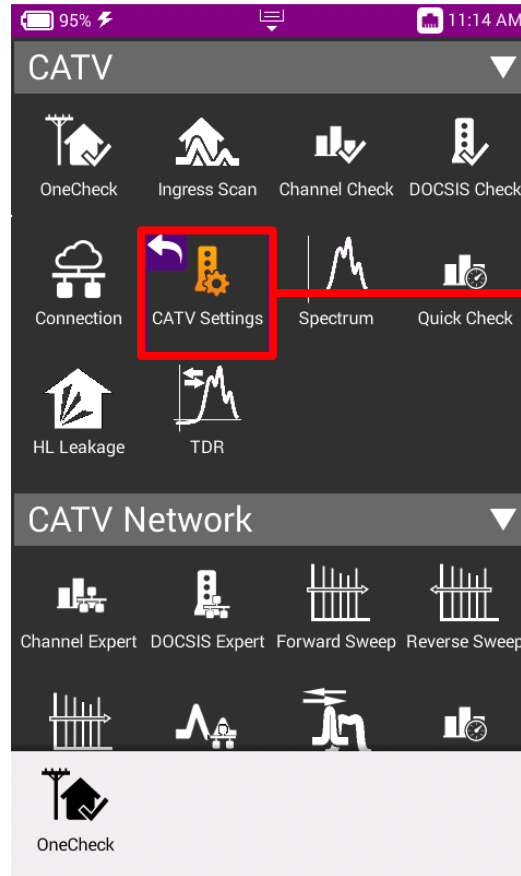

Home Screen

Home Screen



HOME is the default screen when OneExpert CATV is powered on

- It can be reached by selecting the **HOME** screen button above the On/Off Button
- Back Button from any test also returns the user to the **HOME** screen

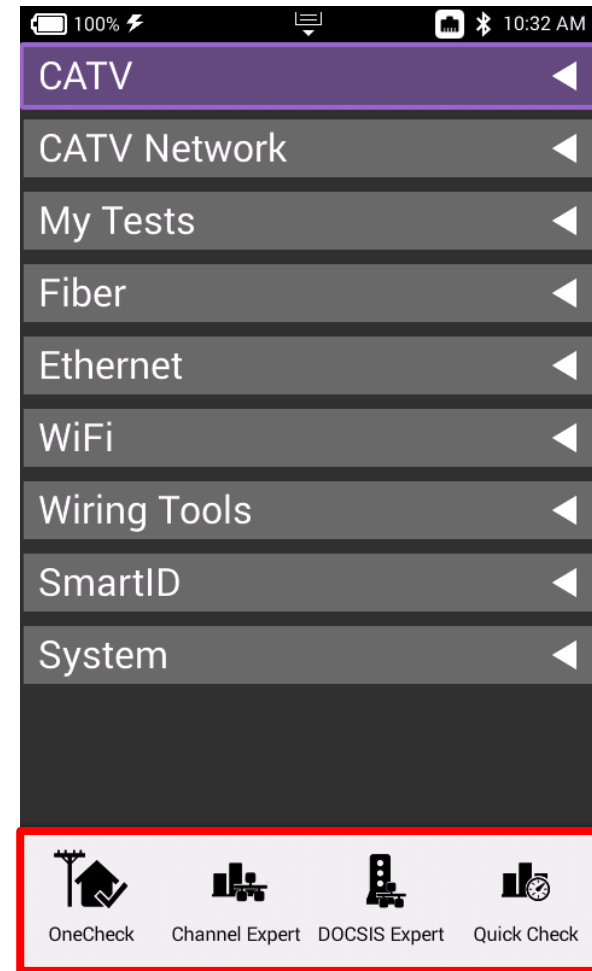

Home Screen

SHORTCUTS can be created by touching and holding a desired function icon and then dragging it to the bottom of the screen

TEST FUNCTION ICONS can also be rearranged like a mobile device

Each **MENU** option is labeled and can be opened or collapsed by the triangle buttons to the right

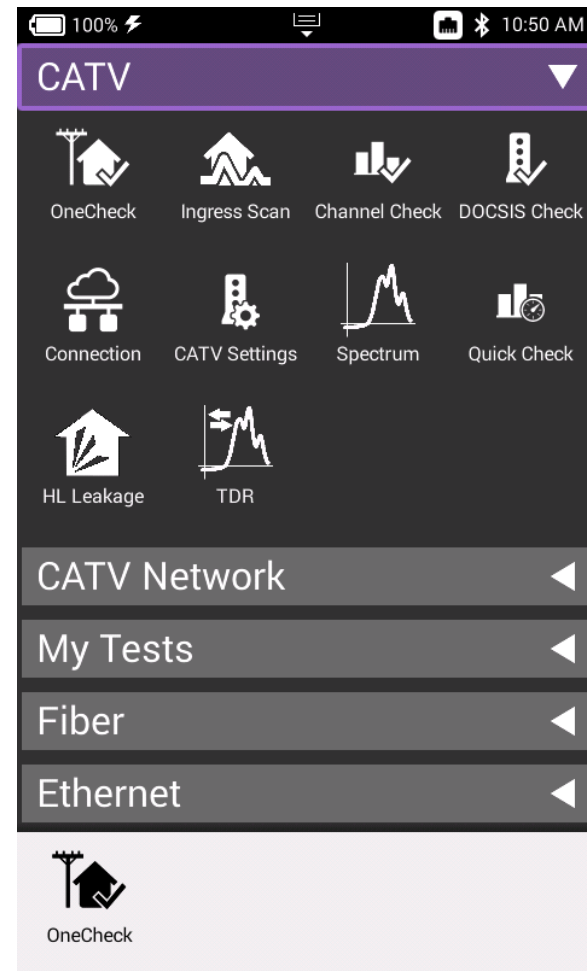
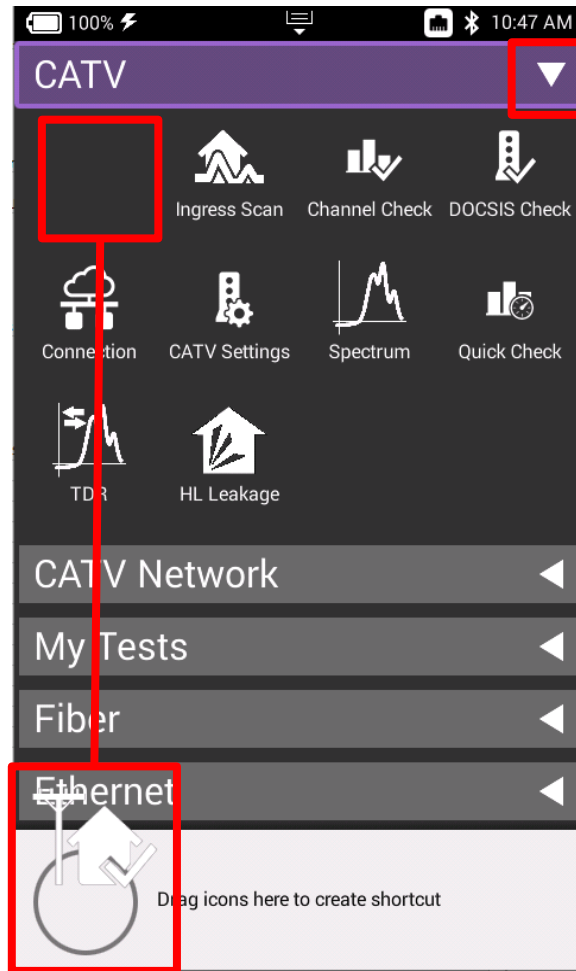

Utility Menu

Utility Menu

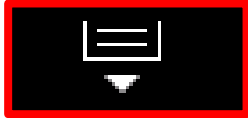

SAVE REPORT – Saves the results to a report. Formats available: XML, PDF, or HTML

VIEW REPORTS – Views a saved report

SCREENSHOT – Takes a screen capture of the current screen

NETWORK – Enables or disables the Ethernet network functions

BLUETOOTH – Enables or disables Bluetooth

VOLUME – Control the device volume

HELP – Provides TAC phone numbers

TUTORIAL – Future enhancement to delivery video tutorials to the OneExpert CATV

WORKFLOW MANAGER - Future enhancement

TEMPLATES – Use to switch between multiple templates and configurations

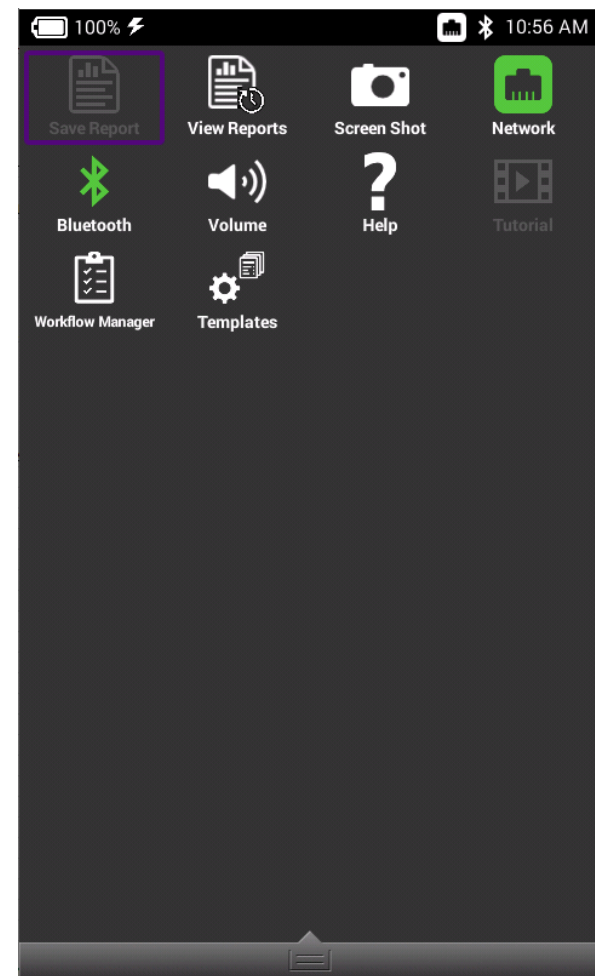

Utility Menu – Screenshot Creation

Select SCREENSHOT from the UTILITY menu, a prompt to save the screenshot will appear

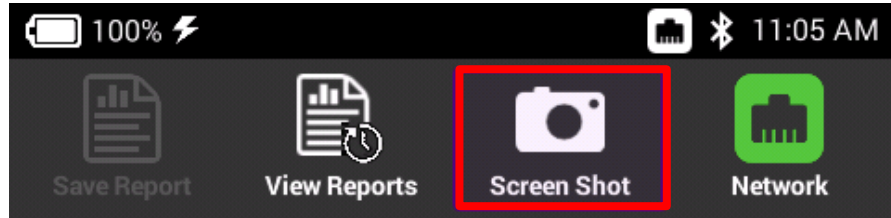

A long push on UTILITY menu key will also automatically start a screen capture

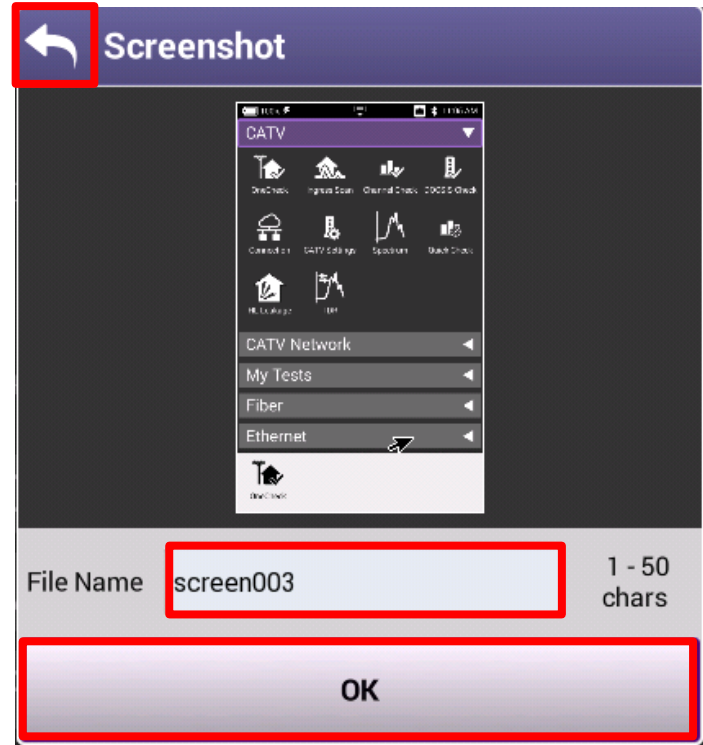

System Settings

System Settings

Navigate from the HOME Screen down to the bottom, using the D PAD or swiping with a finger

Select SYSTEM SETTINGS

From SYSTEM SETTINGS, the user can set up the meter a variety of ways

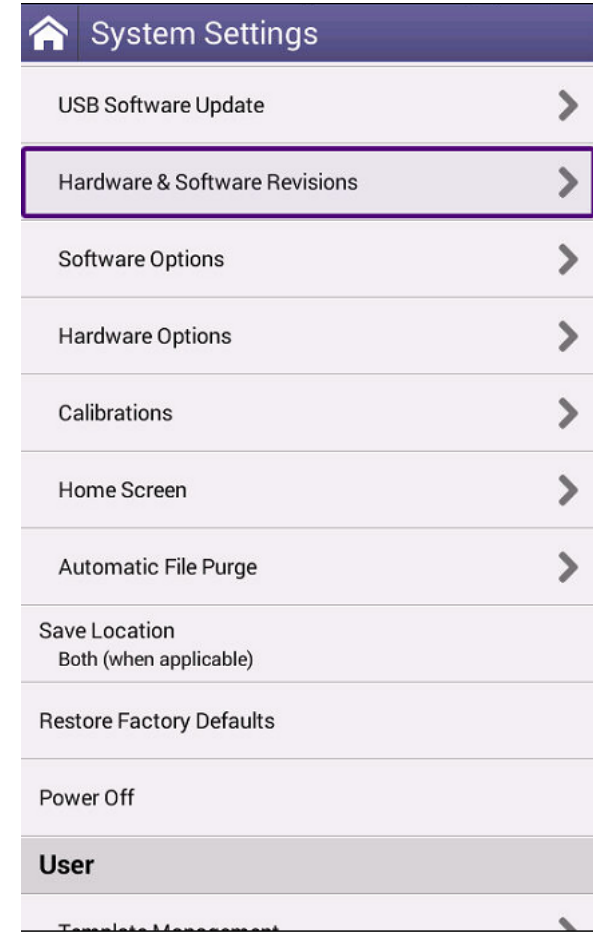
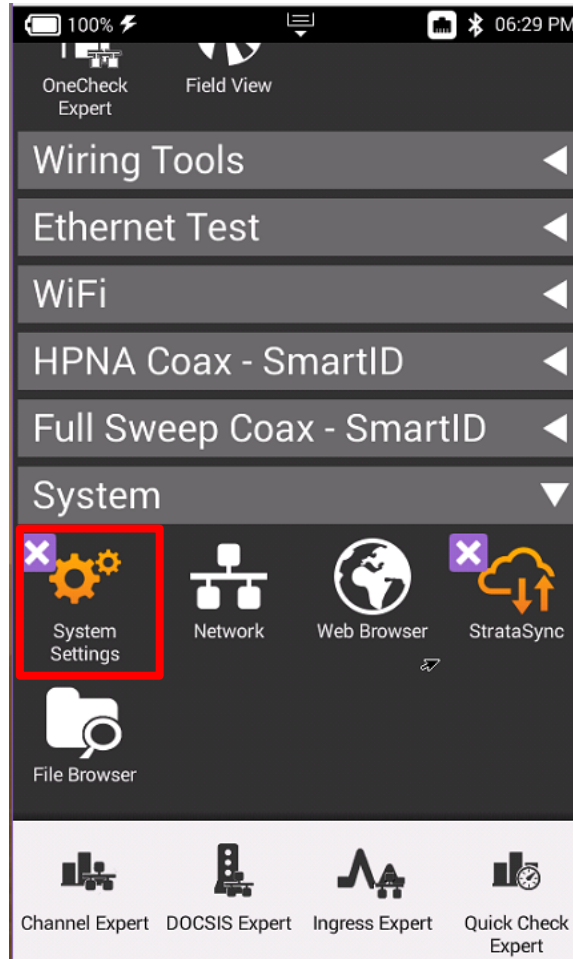

Date and Time

Select DATE AND TIME and make sure that TIME SYNCHRONIZATION is set to STRATASYNC

This is important because test data will be time stamped

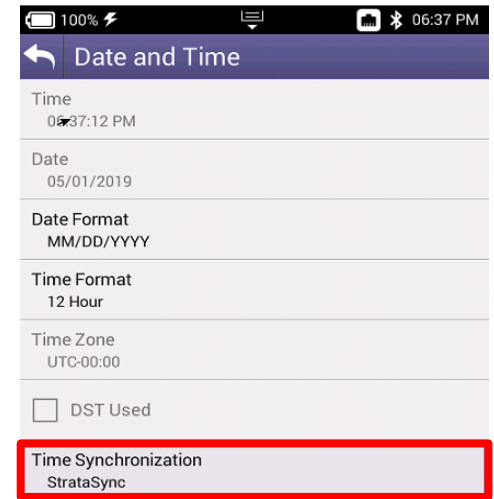
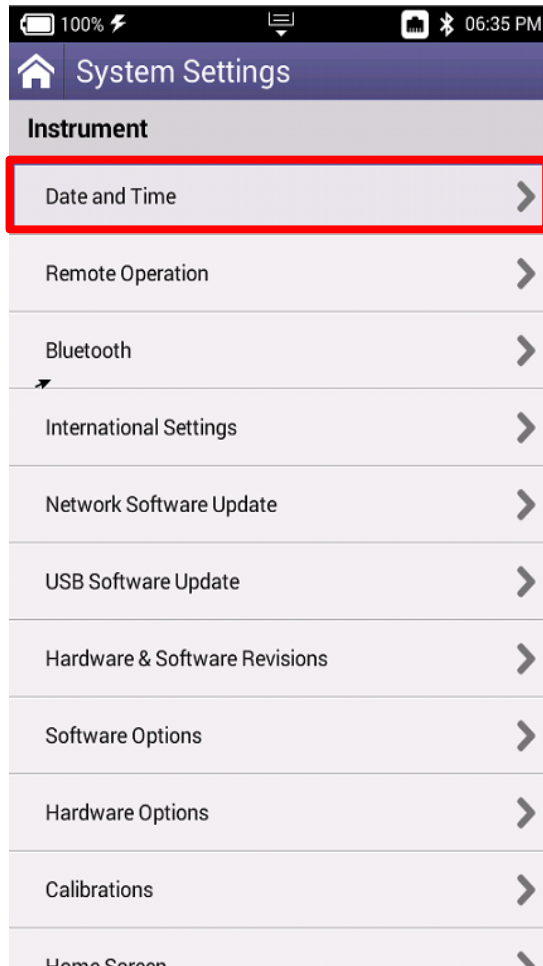

Screen and Power Management

Select SCREEN AND POWER MANAGEMENT to better conserve the ONX battery life

Recommended values are shown to the right. However, if POWER OFF DELAY needs to be set higher in order to accommodate technician's pace, select appropriate time

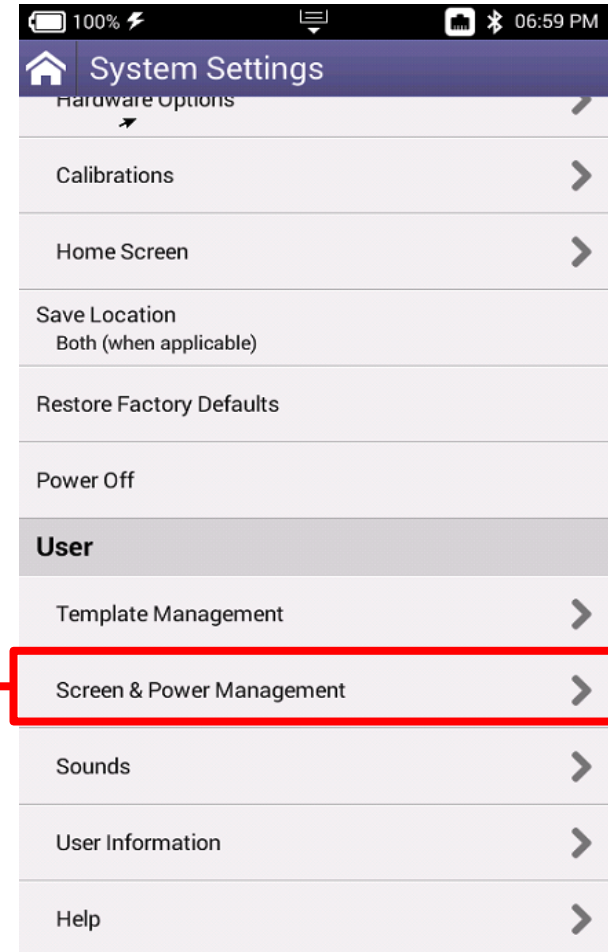
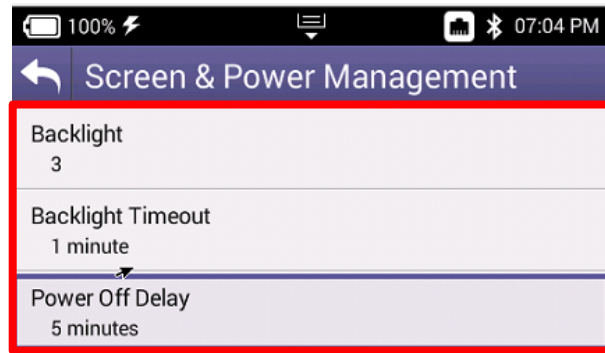

Customizing the Home Screen

Select HOME SCREEN to customize which measurement bundles are available on the HOME screen of the OneExpert CATV

Technicians are invited to customize as needed

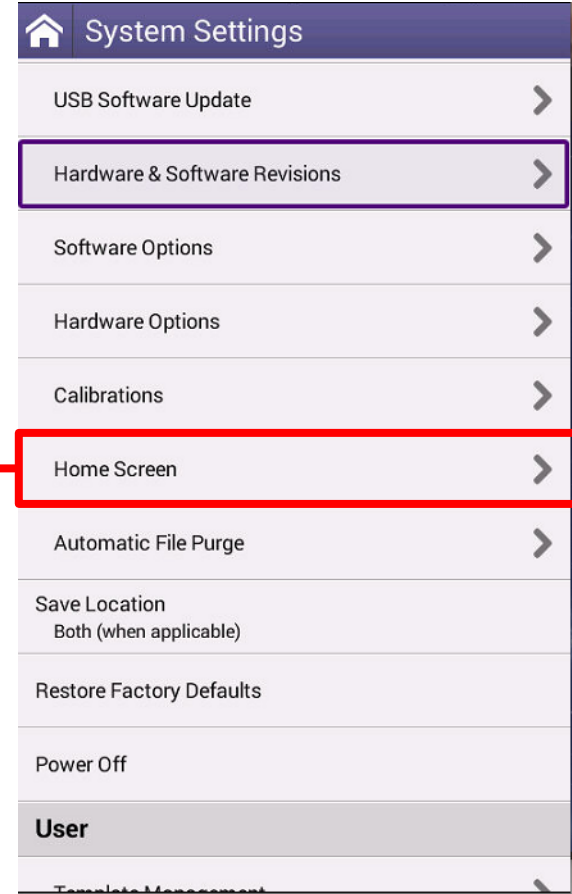
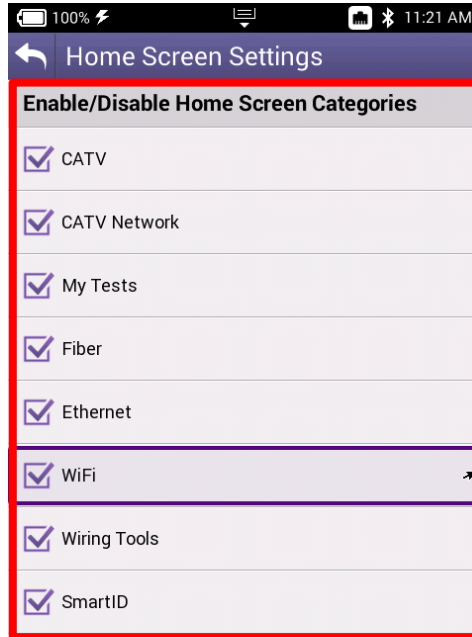

Hardware and Software Revisions

Select HARDWARE & SOFTWARE REVISIONS to verify the most up to date FIRMWARE is installed

Additionally, OneExpert CATV Serial Number (listed as Unit ID) and CM MAC Addresses (used in provisioning of the onboard Cable Modem)

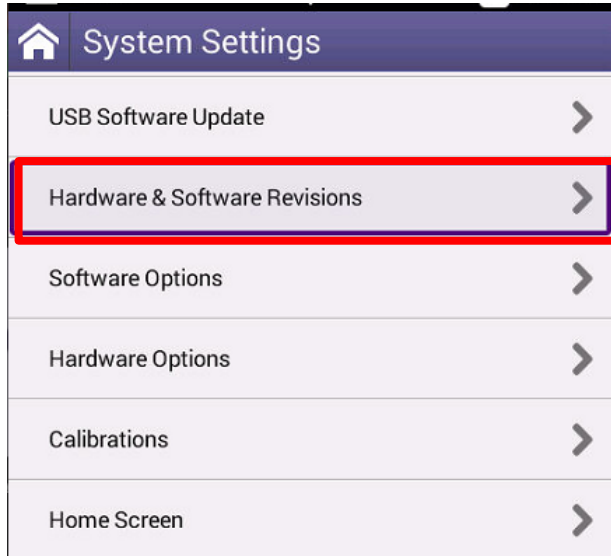

Purge Files

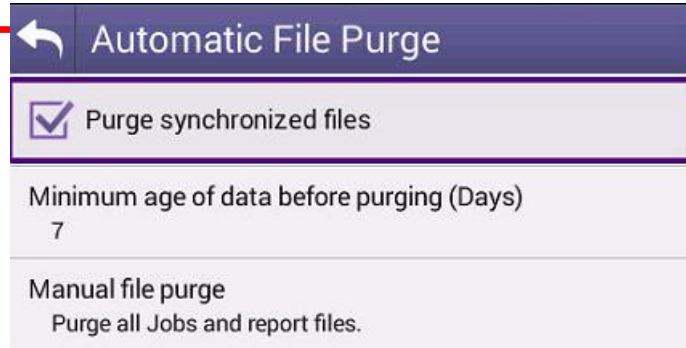
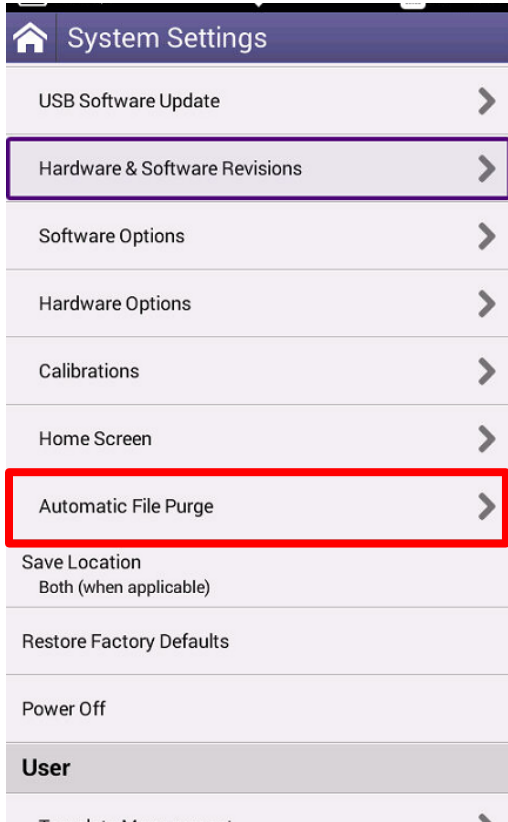

CATV Settings

CATV Settings

Navigate from the HOME screen to
CATV SETTINGS

- Units of Measure
- Tilt
- Hardware Configuration
- Channel Plan Build Settings
- Digital Measurement Settings
- One Check Expert Settings
- Ingress Measurement Settings
- Debug Utilities
- Cable Type
- Automatic File Purge
- DOCSIS Setting

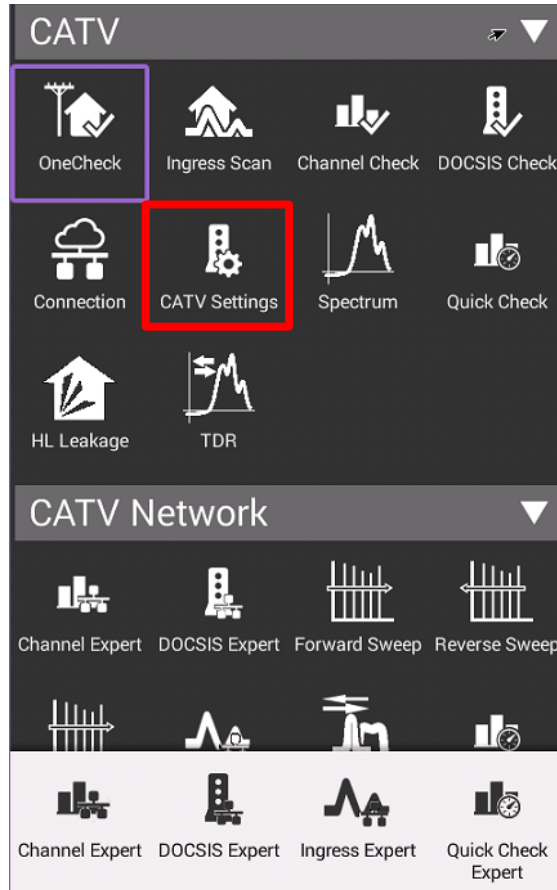

CATV Settings

CATV Settings

Configuration

- Units
- Tilt Configuration
- Hardware Configuration
- Channel Plan Build Settings
- Digital Measurement Settings
- OneCheck Expert Settings
- Ingress Measurement Settings
- Debug Utilities
- Cable Type
- Automatic File Purge
- DOCSIS Settings

Units

Signal Level Units
dBmV

Leakage Level Units
µV/m

Hum Level Units
Percent (%)

Tilt Configuration

Low Tilt Channel (MHz)
54.000

High Tilt Channel (MHz)
860.000

Hardware Configuration

Diplexer Options
AUTO

Select Diplexer Options

AUTO

42 - 1000 MHz

85 - 1200 MHz

Ingress Measurement Settings

Allow scanning to 204 MHz

Ingress High Frequency
42.000 MHz - Real Time

Select Span High Frequency

42.000 MHz
Real Time

65.000 MHz
Real Time

85.000 MHz
Real Time

110.000 MHz
Real Time

CATV Setting

CATV Settings

- Configuration
- Units
- Tilt Configuration
- Hardware Configuration
- Channel Plan Build Settings**
- Digital Measurement Settings**
- OneCheck Expert Settings
- Ingress Measurement Settings
- Debug Utilities**
- Cable Type
- Automatic File Purge**
- DOCSIS Settings

Channel Plan Build Settings

- Enable Channel Plan Rebuild on New Work Order
- Add Quick Check Channels to Channel Plan

Debug Utilities

- Enable CM log

Only check if
troubleshooting DOCSIS

Digital Measurement Settings

- OneCheck (Expert)**
- Measure BER 1.0e-9 (will slow OneCheck)
- BER Dwell Multiplier
1
- OneCheck (Expert) BER Channel Extension**
- Extend BER Testing within Uncertainty Band
- Lower Uncertainty Threshold
1.0e-7
- Extended Test Dwell Multiplier**
3
- Channel Check**
- Measure BER 1.0e-9 (will slow Channel Check)

>20 seconds
per QAM

Automatic File Purge

- Purge synchronized files
- Minimum age of data before purging (Days)
7
- Manual file purge
Purge all Work Orders and report files.

CATV Settings

Home CATV Settings

Configuration

- Units
- Tilt Configuration
- Hardware Configuration
- Channel Plan Build Settings
- Digital Measurement Settings
- OneCheck Expert Settings**
- Ingress Measurement Settings
- Debug Utilities
- Cable Type
- Automatic File Purge
- DOCSIS Settings

← OneCheck Expert Settings

- Ingress Scan**
- Downstream**
- DOCSIS**

← OneCheck Expert DOCSIS Settings

- DOCSIS Test Enabled

DOCSIS

- DOCSIS Range Only
- DOCSIS Range and Register

Service Tests

- DOCSIS Throughput
- DOCSIS Packet Quality

← OneCheck Expert Ingress Scan Settings

- Ingress Scan Test Enabled

← OneCheck Expert Downstream Settings

Downstream

- Downstream Test Enabled
- Off-Air Ingress

Digital

- MER / Echo / GD / ICFR / Hum
- BER

Analog

- Carrier To Noise

Video Analysis

- Video Analysis
- Out Of Band (OOB) Carrier Activity

CATV Settings

CATV Settings

- Units
- Tilt Configuration
- Hardware Configuration
- Channel Plan Build Settings
- Digital Measurement Settings
- OneCheck Expert Settings
- Ingress Measurement Settings
- Debug Utilities
- Cable Type**
- Automatic File Purge
- DOCSIS Settings**

Cable Type Selection

Cable Loss specified at 55.000 MHz

- Custom
VOP: 1.00 Loss: 0.00 dB / 100 ft
- RG6**
VOP: 0.83 Loss: 1.50 dB / 100 ft
- RG6 PVC**
VOP: 0.78 Loss: 1.50 dB / 100 ft
- RG11**
VOP: 0.83 Loss: 0.95 dB / 100 ft
- RG59 Home**
VOP: 0.78 Loss: 1.88 dB / 100 ft
- RG59 HE Mini**
VOP: 0.83 Loss: 2.60 dB / 100 ft
- RG59 HE Std**
VOP: 0.85 Loss: 1.84 dB / 100 ft
- RG59 Poly**
VOP: 0.67 Loss: 2.60 dB / 100 ft

DOCSIS Settings

- Upstream Reference Bandwidth**
Modem Default
- CM DHCP Additional Wait Time Per Request
0 s
- RG DHCP Additional Wait Time
0 s

Select Upstream Reference Bandwidth

- 1.6 MHz
- 6.4 MHz
- Modem Default**

CATV Settings

CATV Settings

Navigate from the HOME screen to CATV SETTINGS

- IPv4 or IPv6
- Tilt
- Sweep
- Diplex
- Digital Measurement
- Channel Plan Build Settings

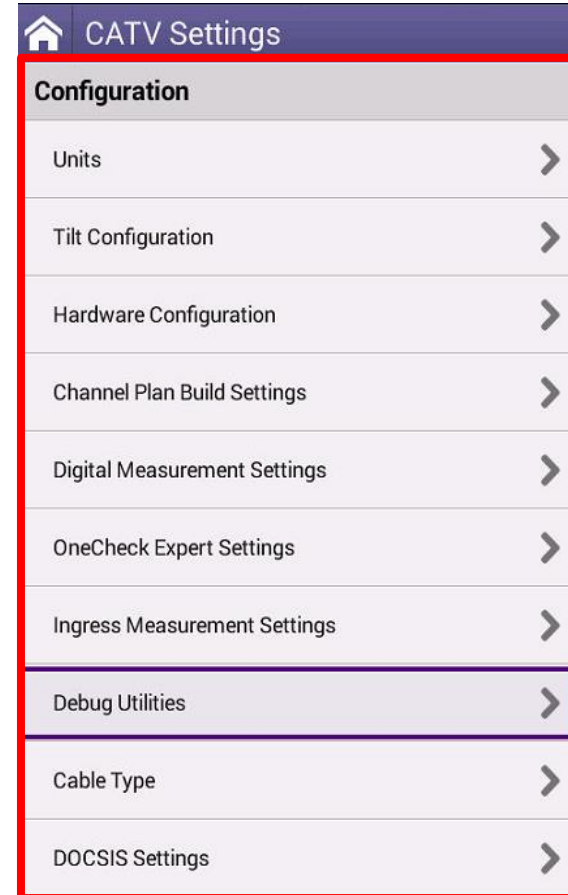
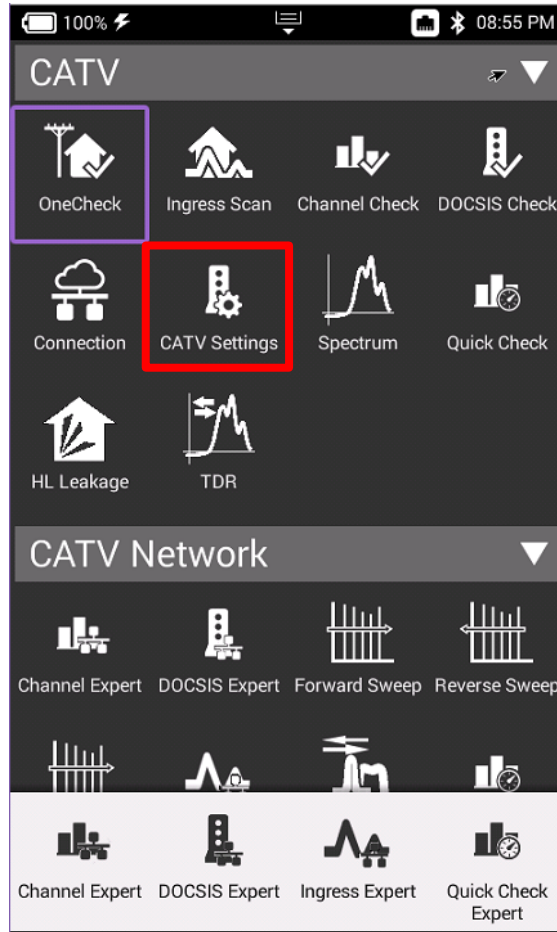

Advanced CATV Settings

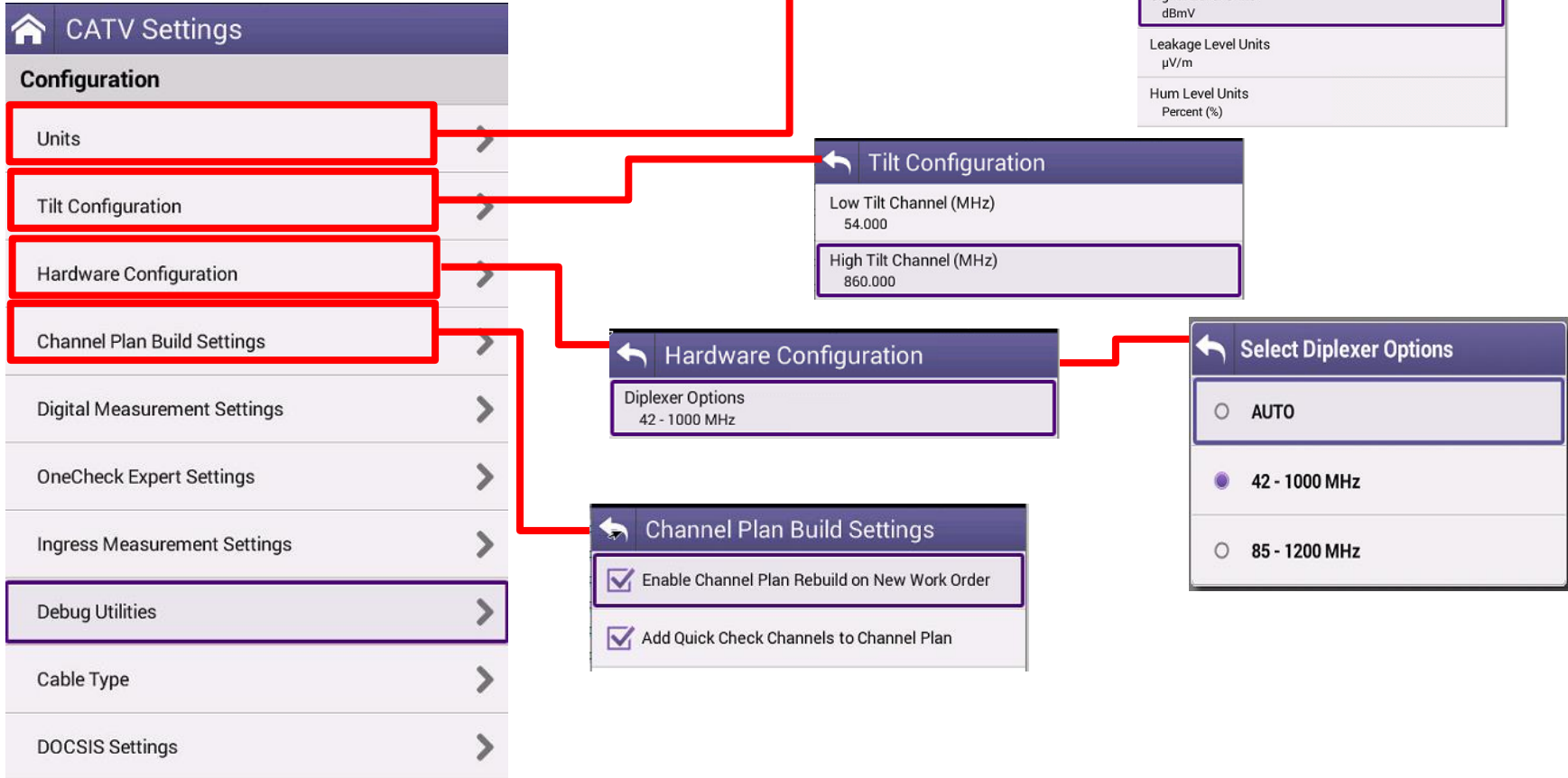

Advanced CATV Settings

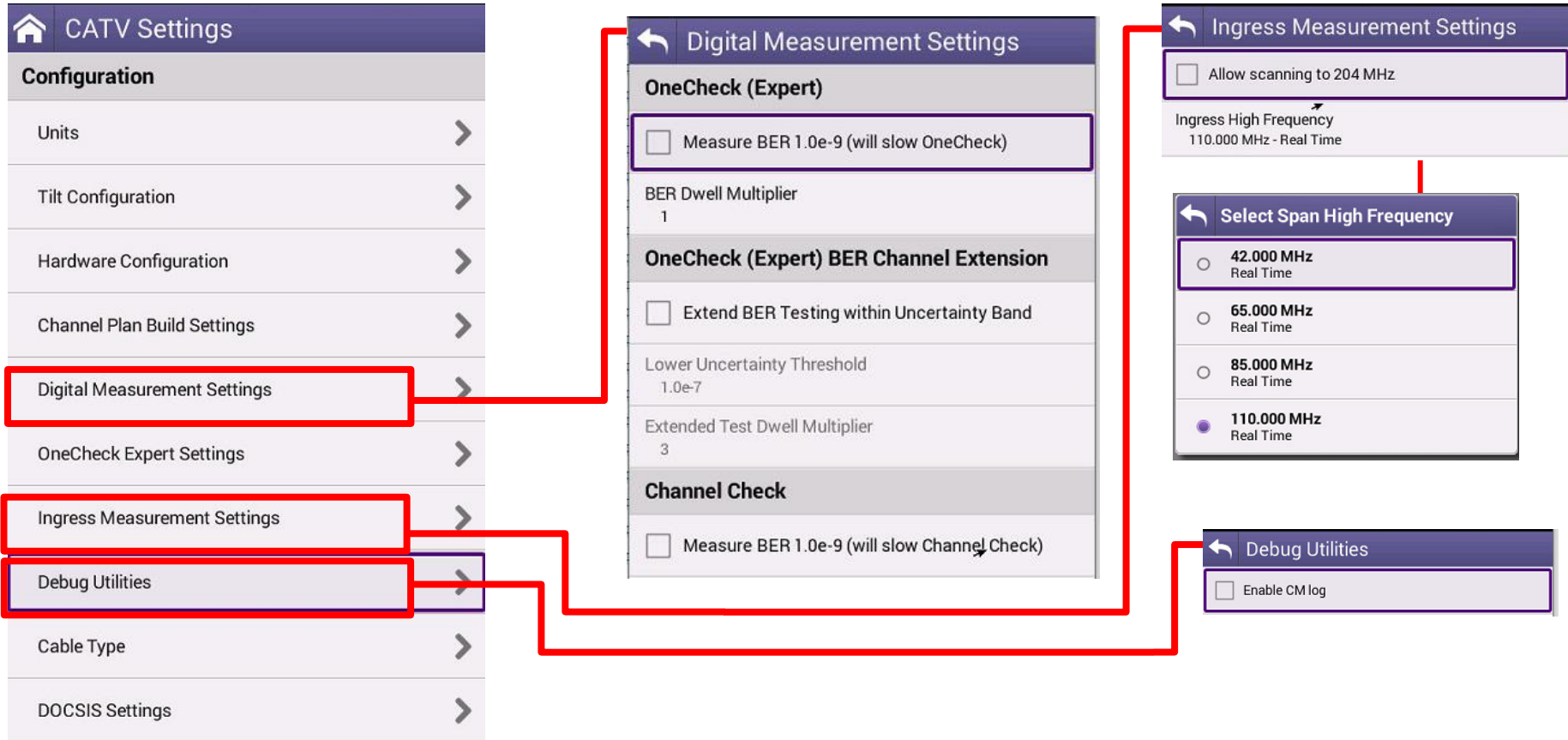

Advanced CATV Settings

CATV Settings

Configuration

- Units >
- Tilt Configuration >
- Hardware Configuration >
- Channel Plan Build Settings >
- Digital Measurement Settings >
- OneCheck Expert Settings >**
- Ingress Measurement Settings >
- Debug Utilities >**
- Cable Type >
- DOCSIS Settings >

OneCheck Expert Settings

- Ingress Scan >**
- Downstream >**
- DOCSIS >**

OneCheck Expert DOCSIS Settings

- DOCSIS Test Enabled

DOCSIS

- DOCSIS Range Only
- DOCSIS Range and Register

Service Tests

- DOCSIS Throughput
- DOCSIS Packet Quality

OneCheck Expert Ingress Scan Settings

- Ingress Scan Test Enabled

OneCheck Expert Downstream Settings

Downstream

- Downstream Test Enabled
- Off-Air Ingress

Digital

- MER / Echo / GD / ICFR / Hum
- BER

Analog

- Carrier To Noise

Video Analysis

- Video Analysis
- Out Of Band (OOB) Carrier Activity

Advanced CATV Settings

CATV Settings

Configuration

- Units >
- Tilt Configuration >
- Hardware Configuration >
- Channel Plan Build Settings >
- Digital Measurement Settings >
- OneCheck Expert Settings >
- Ingress Measurement Settings >
- Debug Utilities >**
- Cable Type >**
- DOCSIS Settings >**

Cable Type Selection

Cable Loss specified at 55.000 MHz

- Custom
VOP: 1.00 Loss: 0.00 dB / 100 ft
- RG6**
VOP: 0.83 Loss: 1.50 dB / 100 ft
- RG6 PVC**
VOP: 0.78 Loss: 1.50 dB / 100 ft
- RG11**
VOP: 0.83 Loss: 0.95 dB / 100 ft
- RG59 Home**
VOP: 0.78 Loss: 1.88 dB / 100 ft
- RG59 HE Mini**
VOP: 0.83 Loss: 2.60 dB / 100 ft
- RG59 HE Std**
VOP: 0.85 Loss: 1.84 dB / 100 ft
- RG59 Poly**
VOP: 0.67 Loss: 2.60 dB / 100 ft

DOCSIS Settings

- Upstream Reference Bandwidth**
Modem Default
- CM DHCP Additional Wait Time Per Request
0 s
- RG DHCP Additional Wait Time
0 s

Select Upstream Reference Bandwidth

- 1.6 MHz
- 6.4 MHz
- Modem Default**

Software and Firmware Updates

Software and Firmware Upgrades

- Software (SW) and Firmware (FW) releases are the best way to ensure your VIAVI OneExpert is functioning at its best
- VIAVI delivers SW and FW easily via **StrataSync** and **USB Stick**
- All OneExpert units should be upgraded to the latest production software release – available through StrataSync (or your Viavi representative)
- New SW Version offer substantial operational improvements and enhancements over earlier software releases including the version that shipped with the units initially
- The software will be deployed to the units by the StrataSync Administrator, but each unit needs to be configured to connect with StrataSync
- Follow these steps to ensure your meter is configured correctly and you can connect to StrataSync to receive the latest updates.

USB Software Upgrade

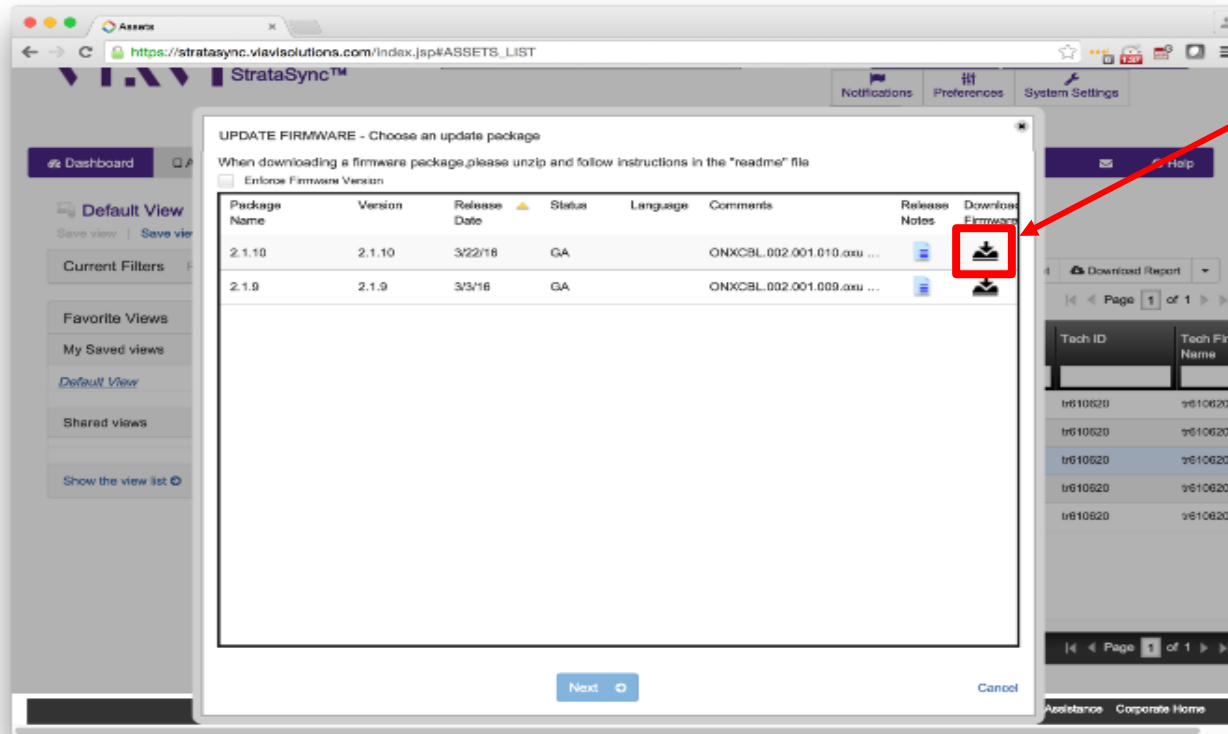

- Click here to download the newest firmware

- Copy the downloaded file ONXCBL.xxx.xxx.xxx.oxu to the root directory of a USB thumb drive.

- Press Cancel once the download has completed and you have placed the file on the USB thumb drive.

Note: Firmware must be downloaded from StrataSync first

USB Software Upgrade

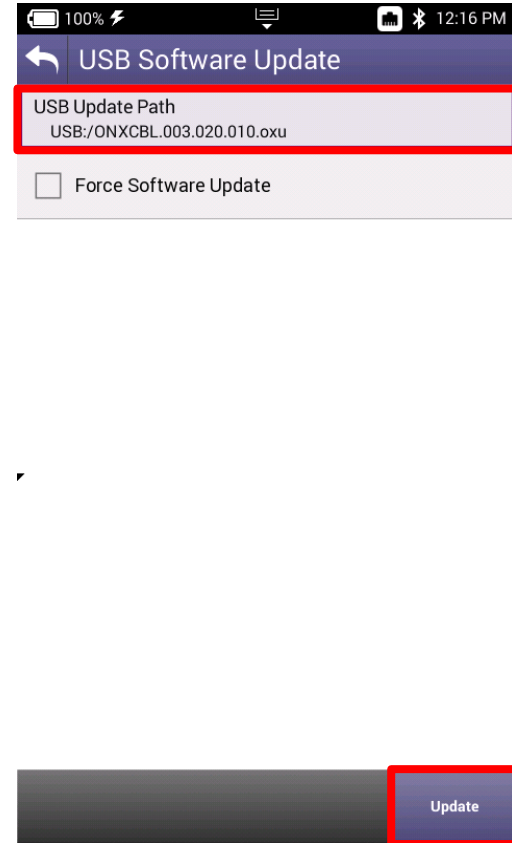
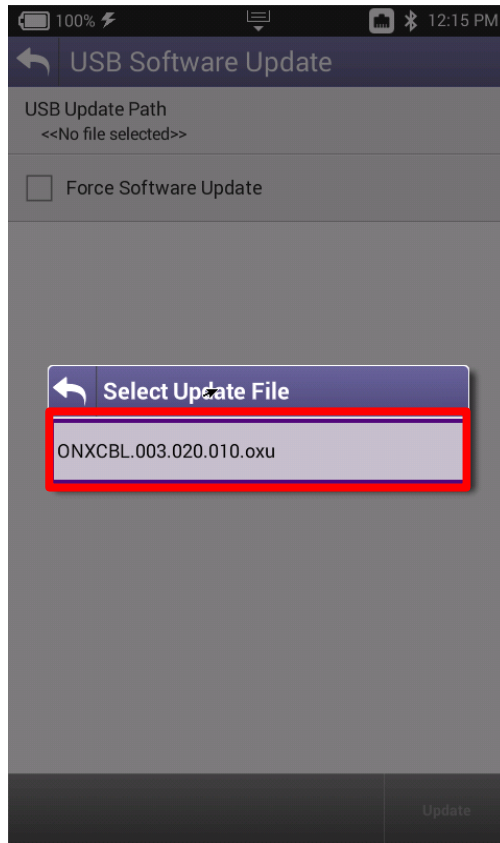
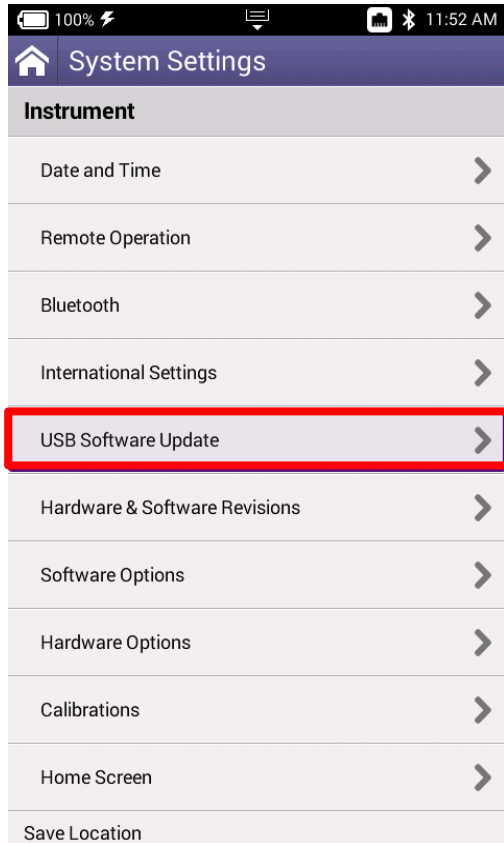

Ethernet Software Upgrade via StrataSync

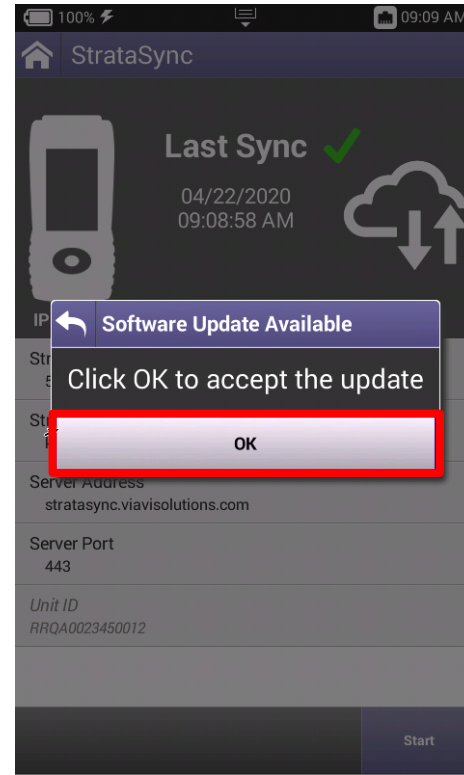
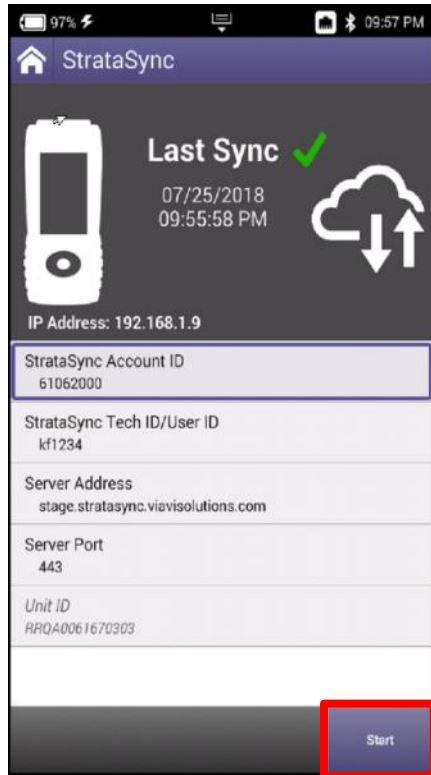

Firmware Recovery Procedure

Place the update image on a USB drive in the root directory (not in any folder on the USB drive). Ensure that it is the only ONX update image on the drive.

Download the latest ONX firmware via StrataSync to get the latest link from Viavi TAC

Power off the unit.(If the unit is frozen, press and hold the power key until the ONX powers off ~10-15 seconds)

Attach power charger to the ONX.

Plug the USB drive with the “.oxu” firmware file into one of the ONX USB ports.

Hold down the left softkey+ right softkey+ up arrow. (softkeys are the 4 buttons just below the display)

Press and release power key as normal while continuing to hold down on the left softkey+ right softkey+ up arrow until you see the



StrataSync Synchronization

StrataSync Synchronization - ETHERNET

Note - You can synchronize to StrataSync via RF or WiFi, but this is ONLY for sending test files, receiving configuration information like limit plans, etc. - not for SW/FW upgrades

Connect an Ethernet cable from an active internet connection (Cable Modem or router/gateway) to Port 1 on the ONX

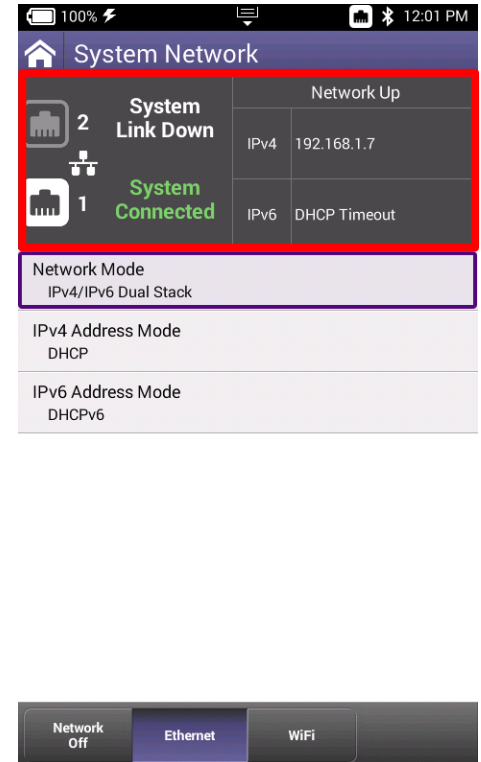
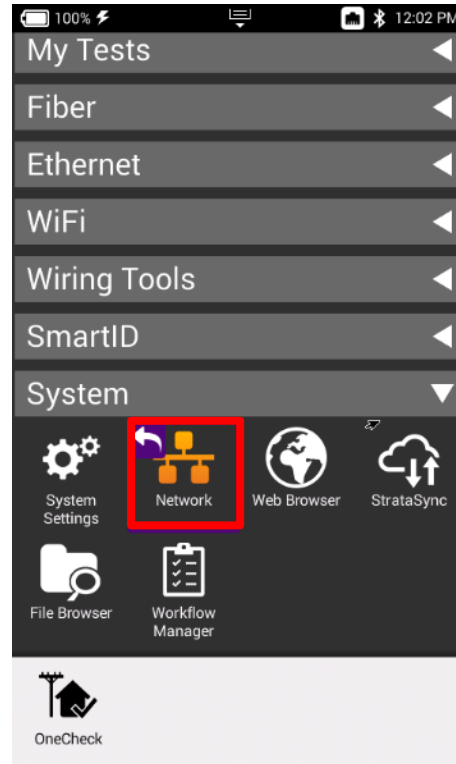

StrataSync Synchronization - WIFI

Note - **Sync via WiFi** is now supported. Use Network Settings app to configure and join a WiFi network prior to performing sync. You can synchronize to StrataSync via WiFi, but this is **ONLY** for sending test files, receiving configuration information like limit plans, etc.

Connect with WiFi from an active internet connection
(Cable Modem or router/gateway)



From the ONX home screen navigate to **SYSTEM NETWORK / WIFI** - Verify the ONX has a valid IP address

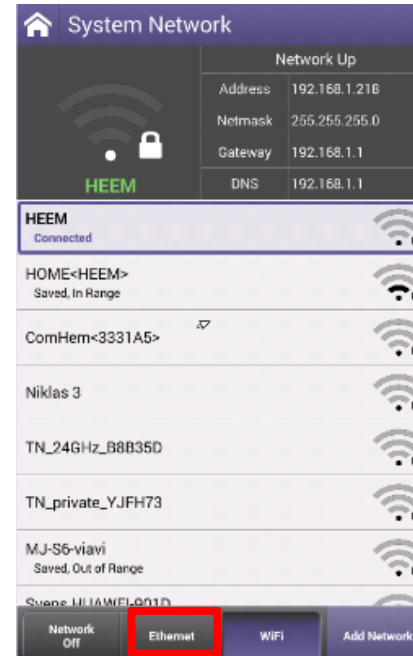

StrataSync Synchronization - RF

Make sure that CM MAC 1 is provisioned in the billing system
Select the CONNECTION APP from CATV

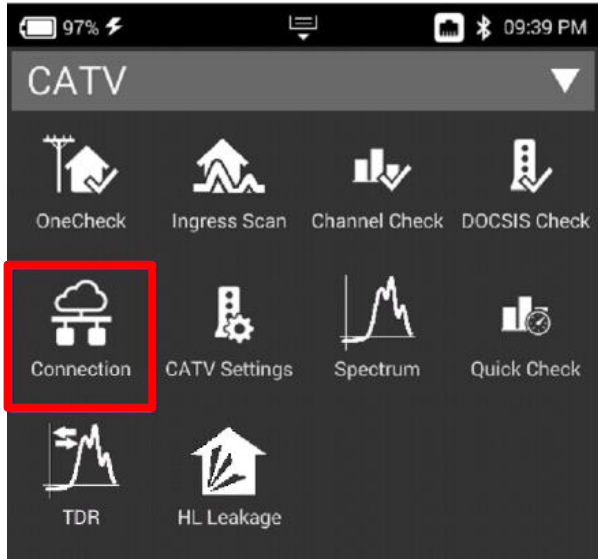

Once CONNECTION STATUS reports a GREEN Check mark and
INTERFACE: RF; IP ADDRESS is shown

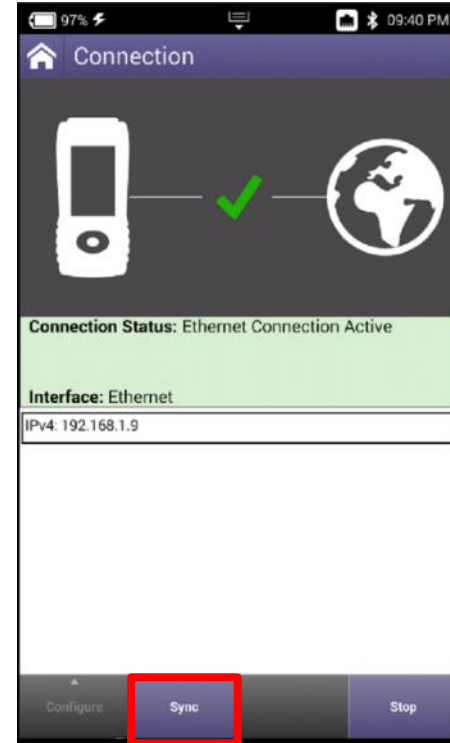

StrataSync Synchronization – ETHERNET, WIFI and RF

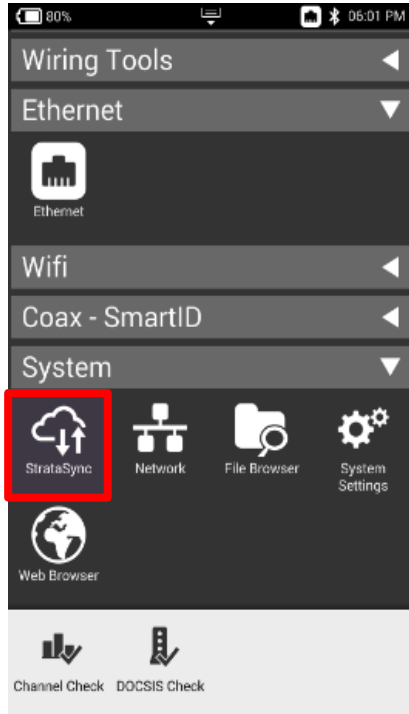

After IP Address verification, navigate to the **SYSTEM** Menu and select **STRATASYNC**

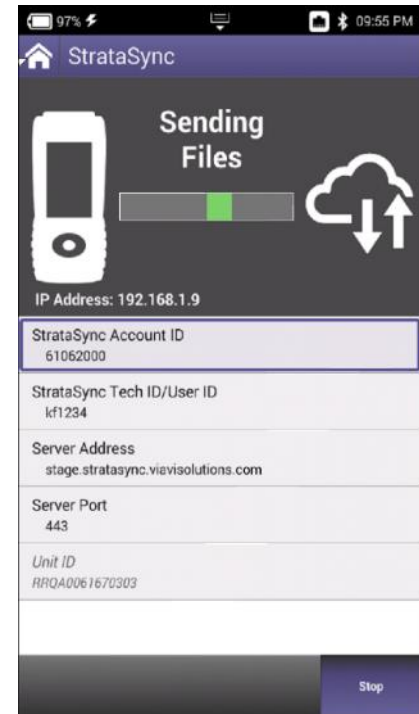
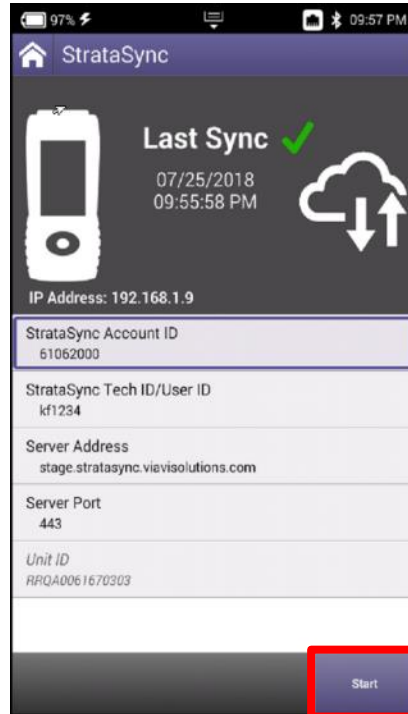

STRATASYNC ACCOUNT ID = xxxxxxxx
SERVER ADDRESS = stratasync.jdsu.com
(stratasync.viavisolutions.com also works)
SERVER PORT = 443

Mobile Tech App

MOBILE TECH APP

Search for VIAVI and download VIAVI MOBILE TECH v3.1 app

* Screenshots shown on iPhone, but MOBILE TECH APP on ANDROID is consistent

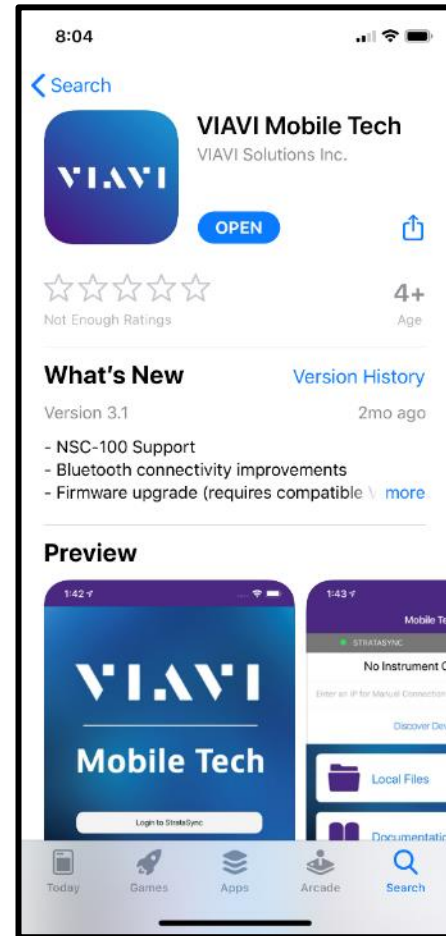

MOBILE TECH APP – Set Up

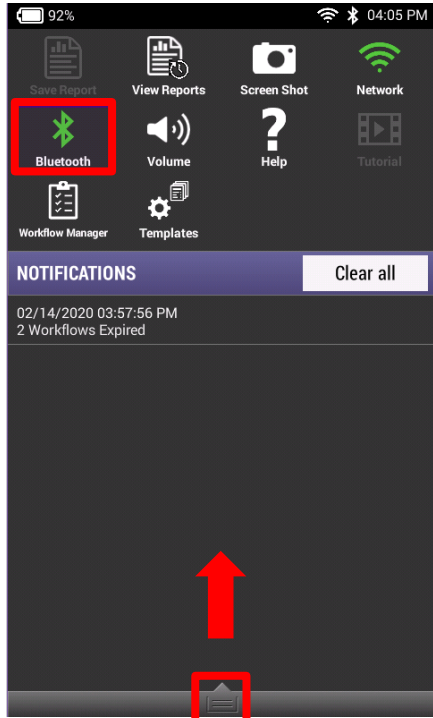

On ONX620 or 630, enable BLUETOOTH by going to SYSTEM SETTINGS->BLUETOOTH SETTINGS or by dragging down the TRAY and selecting BLUETOOTH and GREEN

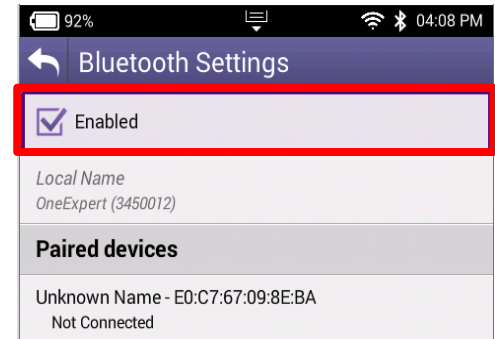
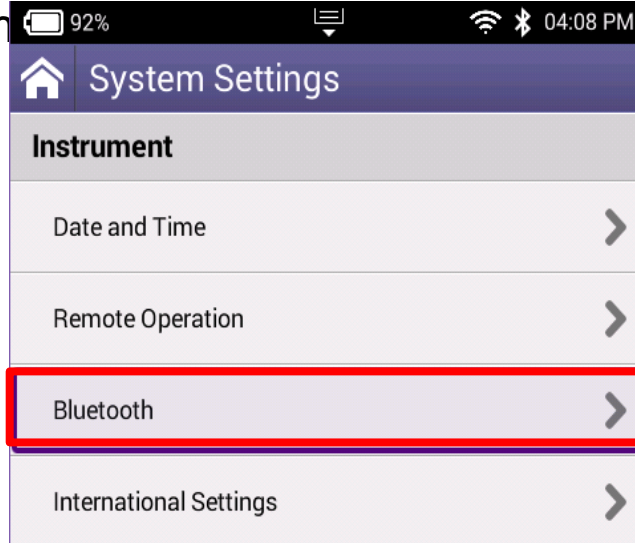

MOBILE TECH APP – Set Up

Select the appropriate OneExpert CATV serial number from the list of BLUETOOTH CONNECTIONS and pair

OneExpert CATV will flash a request message

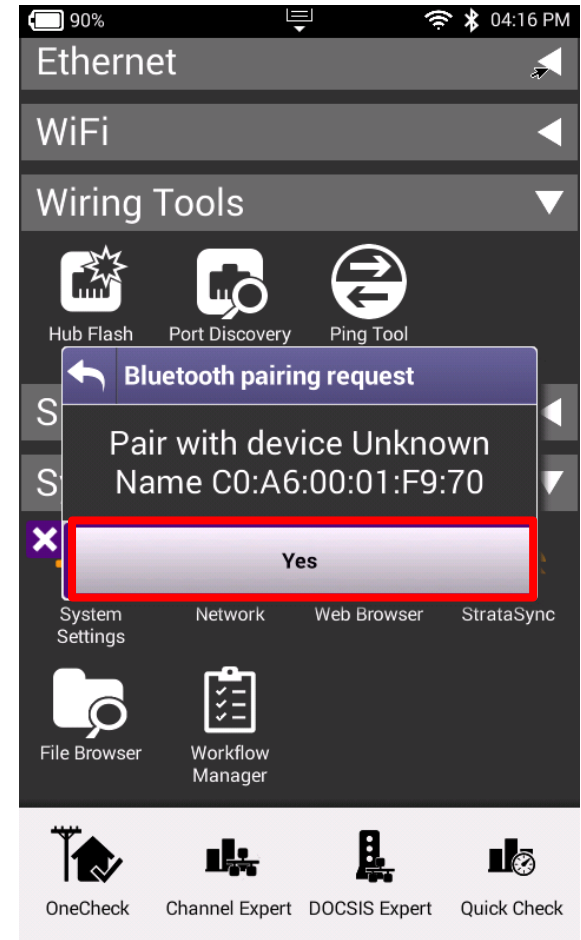
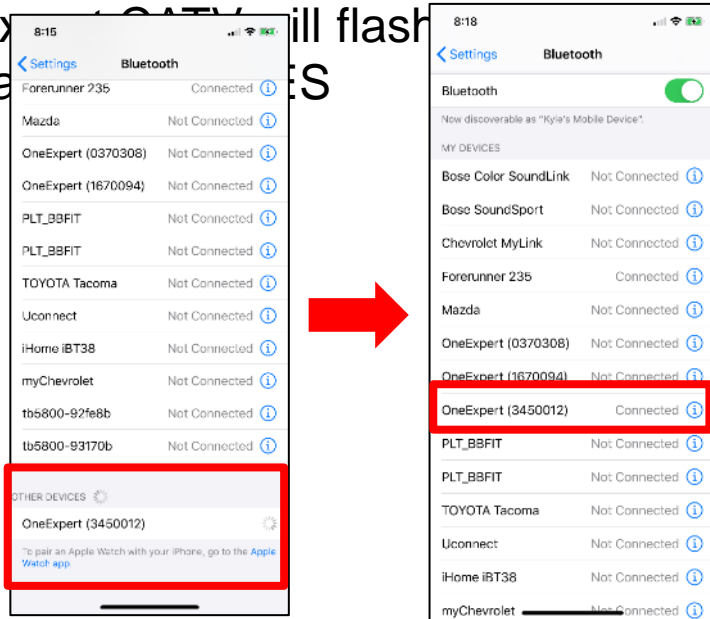

MOBILE TECH APP – Set Up

Login using USERNAME and PASSWORD
If user doesn't have login credentials – please reach out to local STRATASYNC ADMINISTRATOR

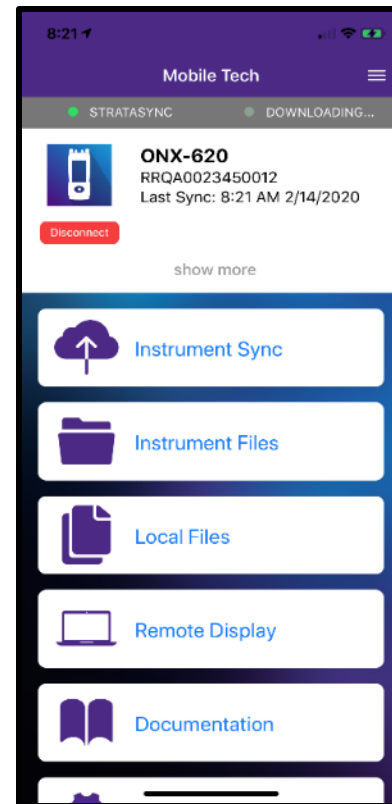
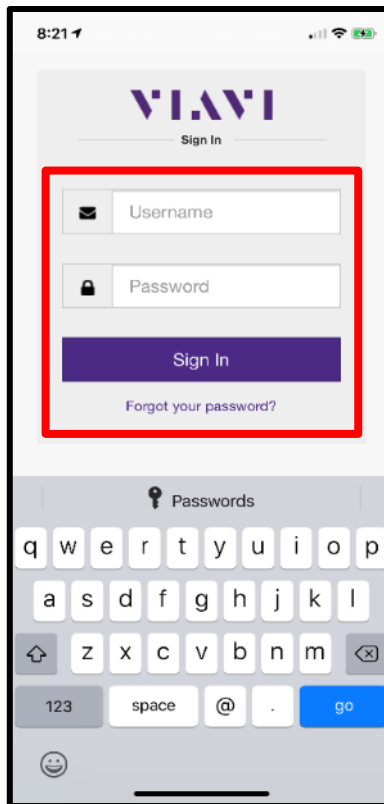
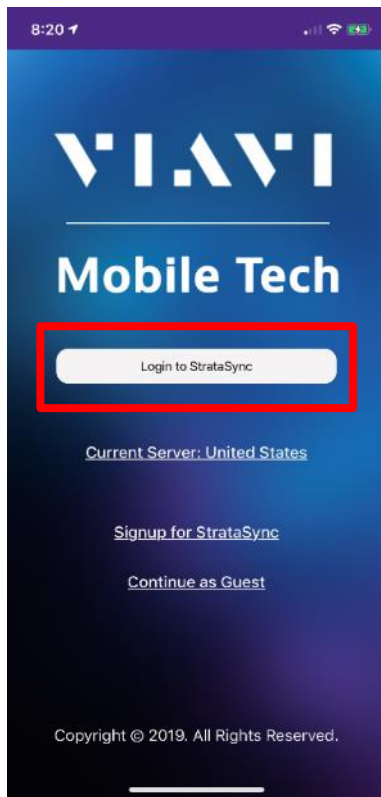
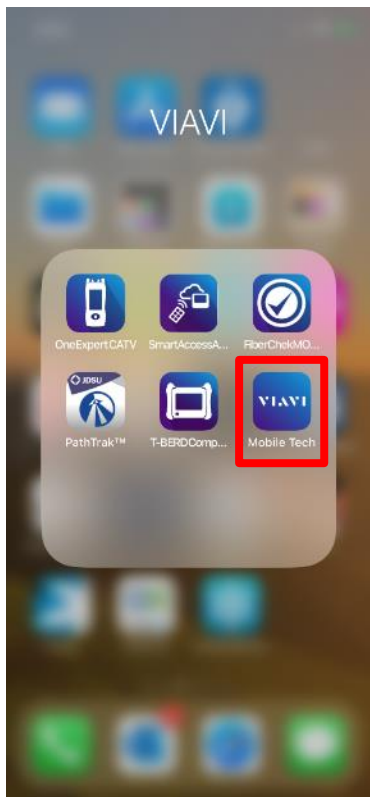

MOBILE TECH APP - Synchronization

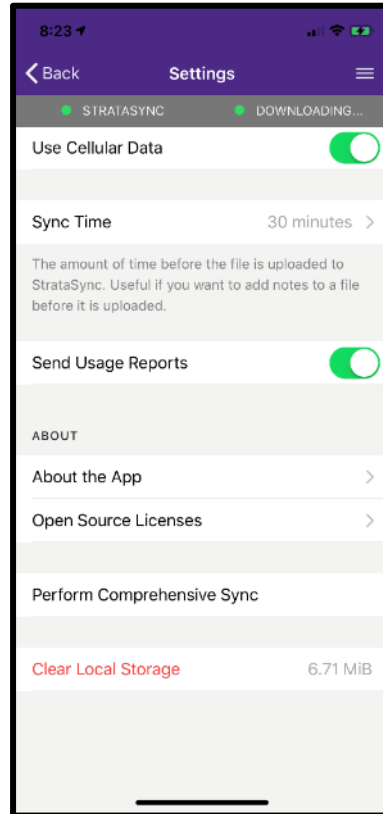
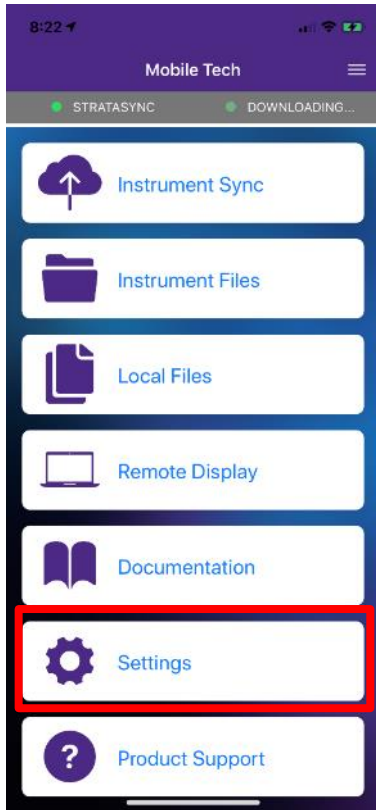

Select the SETTINGS button and configure MOBILE TECH APP

- Choose how often user desires a SYNC
- Whether the SYNC will require WIFI or may use the LTE connection
- Whether or not to send usage reports
- Comprehensive SYNC (useful for uploading failure logs)
- Clear local Storage on user phone

MOBILE TECH APP - Synchronization

By Selecting INSTRUMENT SYNC from the main menu, the USER can see all test data that has currently been saved to the ONX and is ready for sync

- **Note that only SAVED TEST DATA will migrate to MOBILE TECH APP for synchronization to STRATASYNC**

By selecting SYNC – the process will begin immediately

- The user can also rely on the timed sync setting – which allows the MOBILE TECH APP the ability to sync passively in the background at regular intervals

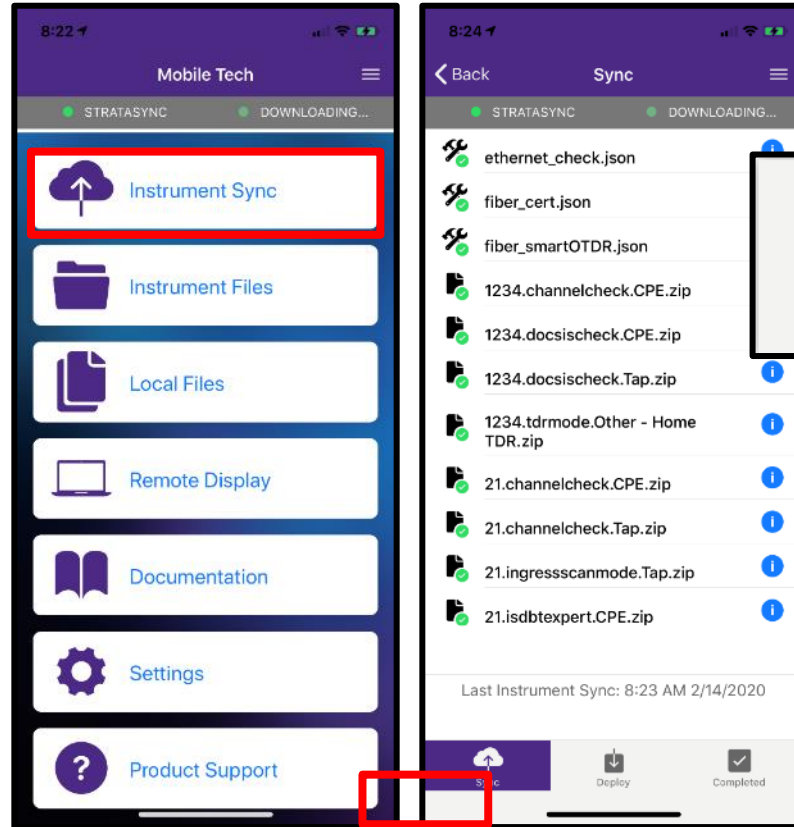

MOBILE TECH APP

- Beyond streamlined sync to STRATASYNC, the MOBILE TECH APP also provides the following functionality:
- View and manager files on the instrument
- View and manage local files, including craftsmanship photos
- Remote Display and Operation
- IN-APP Support Documentation
- LINK to VIAVI Technical Support

- Note – MOBILE TECH APP is interoperable with TB2000, TB4000, TB5800, One EXPERT CATV and a host of other VIAVI Solutions instruments

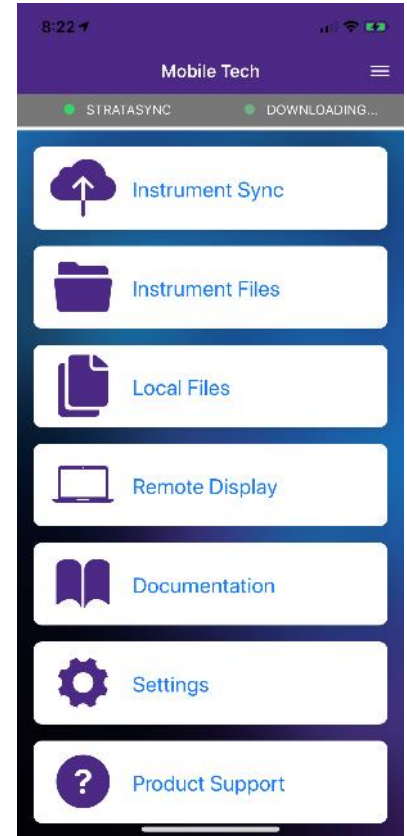

MOBILE TECH APP - Remote Display

REMOTE DISPLAY allows the user to control the ONX, via BLUETOOTH, and conduct normal meter functions

*Requires SmartAccess Anywhere option

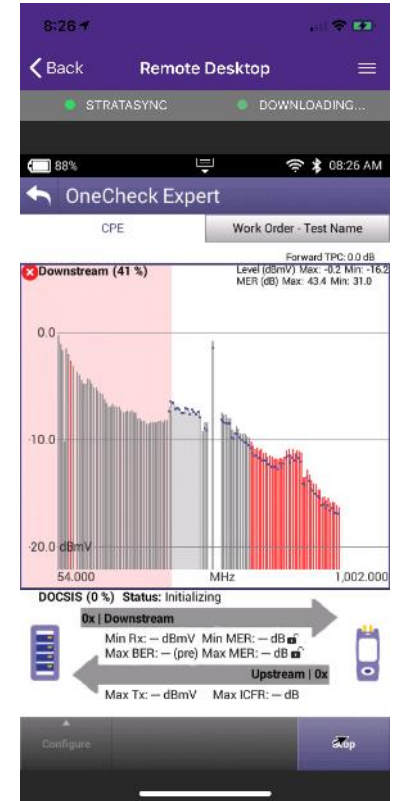
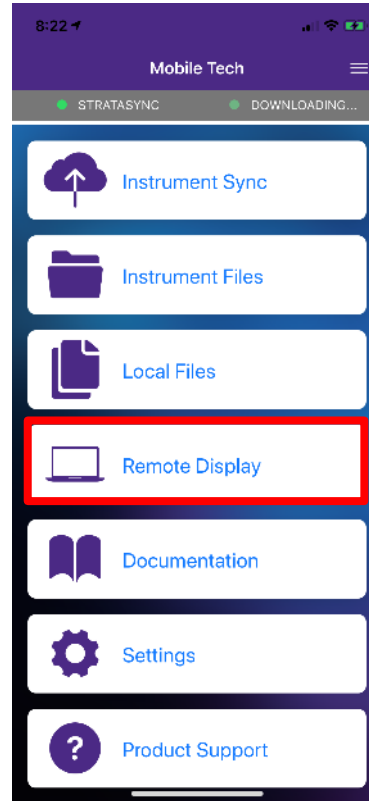

MOBILE TECH APP - LOCAL FILES

Allows users the ability to take photos or use photos from their mobile device and upload to StrataSync

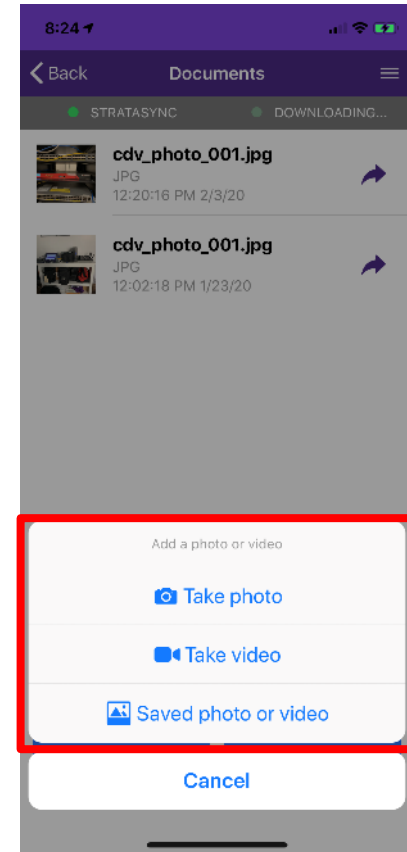
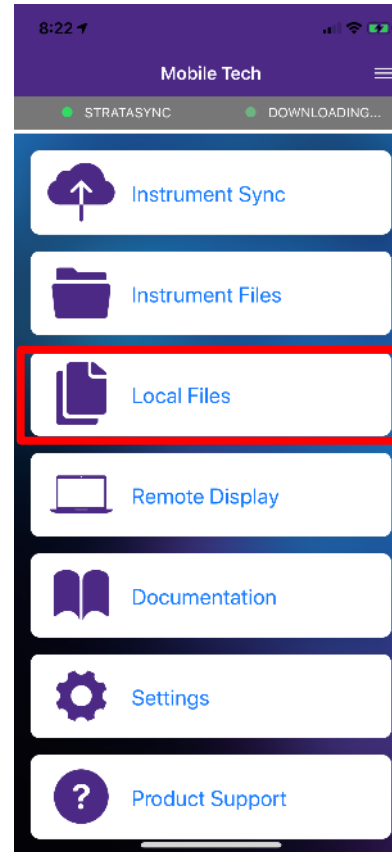

MOBILE TECH APP - Product Support and Documentation

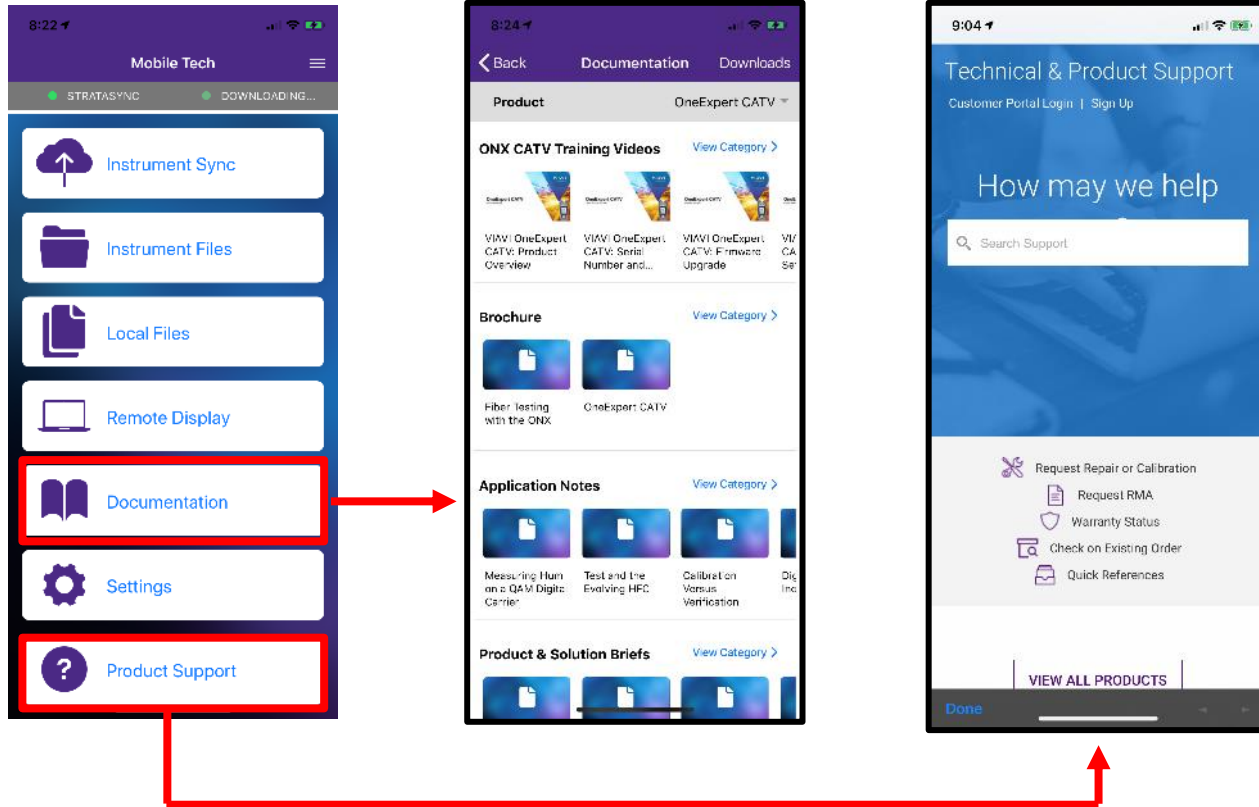

Ethernet Testing



Ethernet – Tests and Settings



From HOME screen, select ETHERNET

Once NETWORK UP is indicated with green, select TEST AND SETTINGS

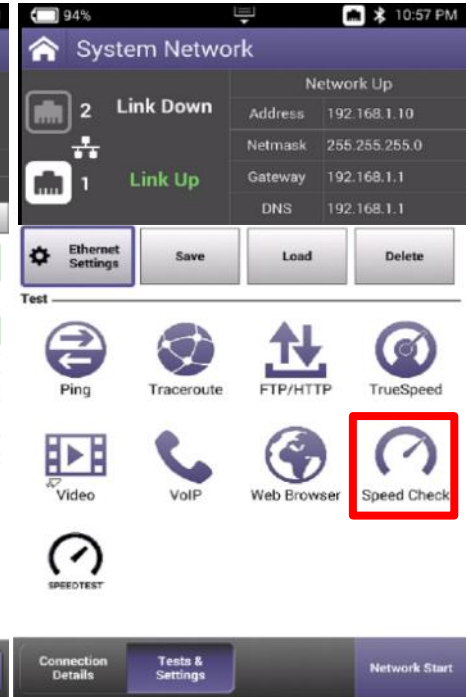
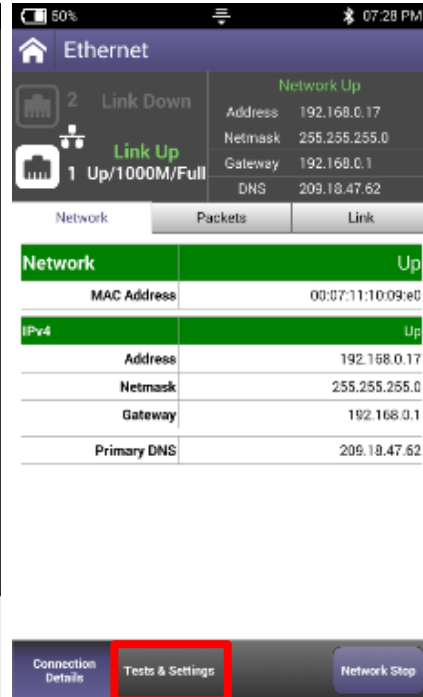
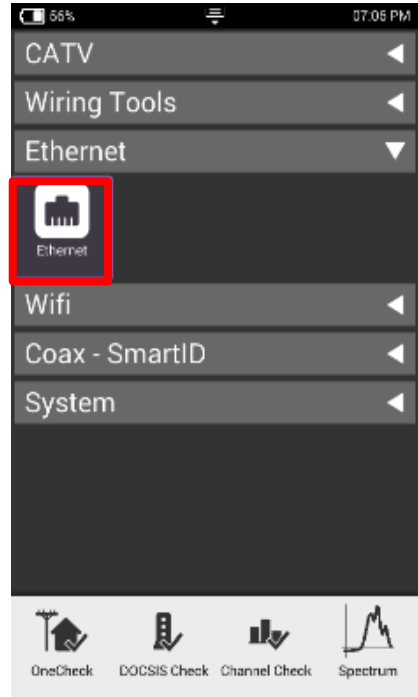

Ethernet – Speed Check

- CATV Ethernet's throughput IP Address/URL is configured in the mode under Settings.
- Default value are for both Downstream/Upstream the same:
<http://CATVSpeedTest.viavisolutions.com/bigfile.zip>
- If the upstream URL changes, the file name need to be the same: bigfile.zip

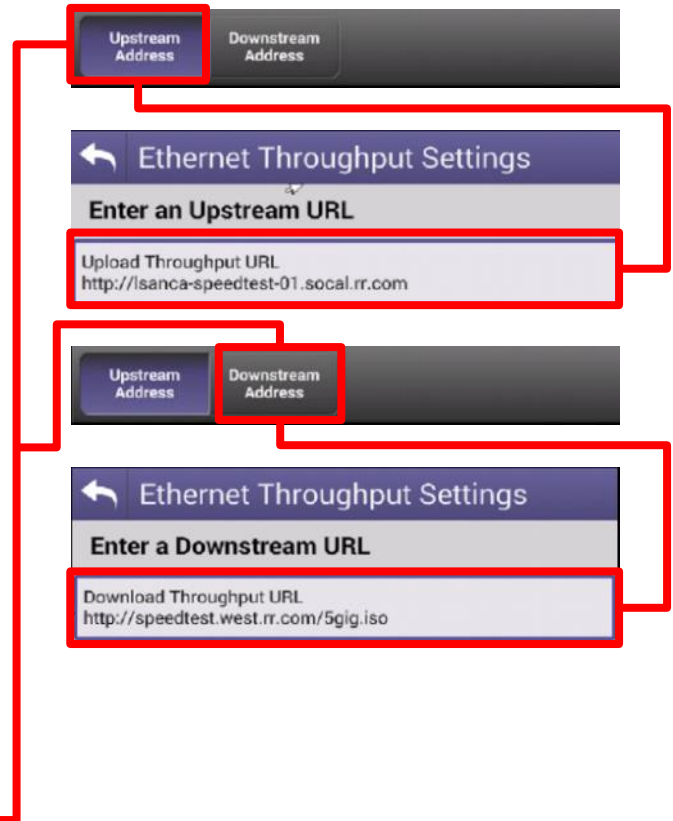
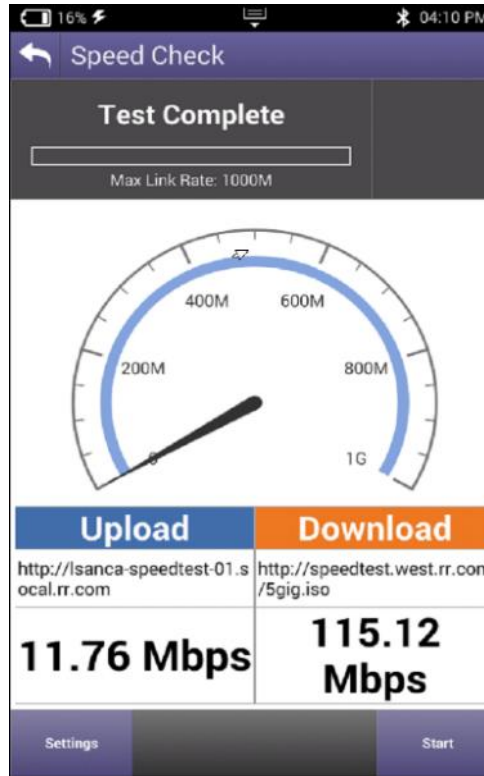
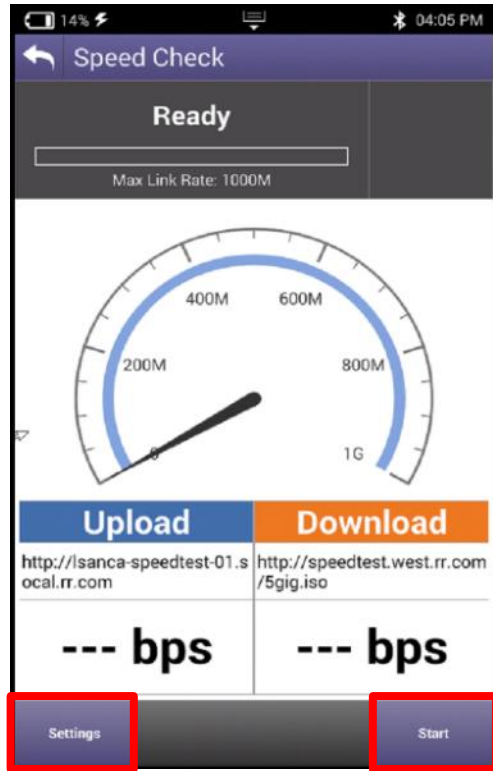

ETHERNET - TrueSpeed Setup

Select Profile or create a new one
The test will start automatically after Profile is selected
Stop Test and choose Server Settings on the bottom and enter the Server IP address and then resume. (Only applicable for first test setup)
Fallback Server is for second TrueSpeed VNF and can help alleviate queue

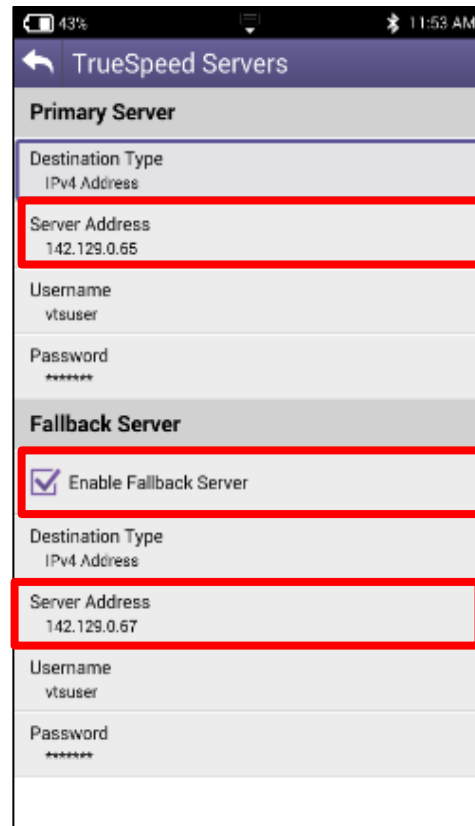
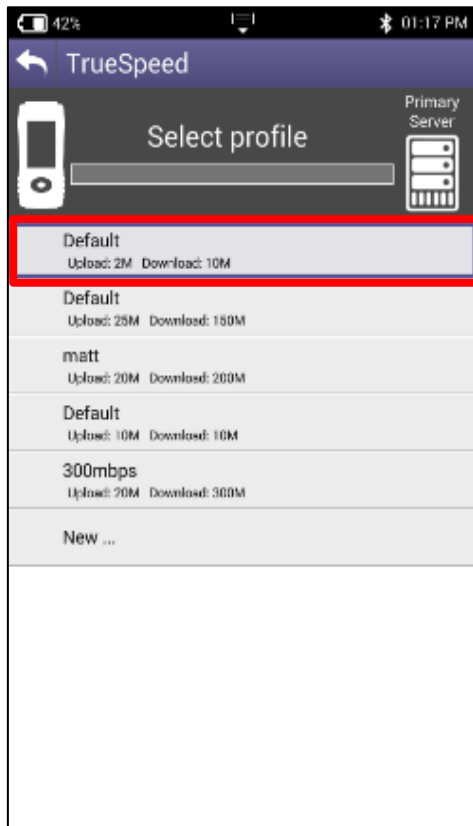
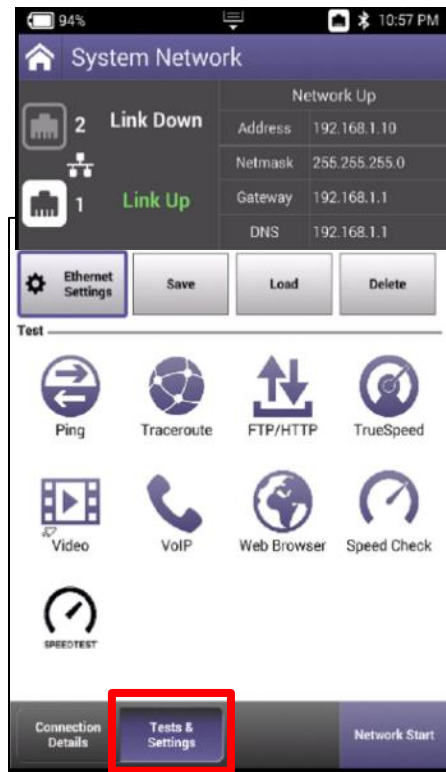

ETHERNET - TrueSpeed Results

After test completes, Results are displayed as either the Speedometer or a simple list

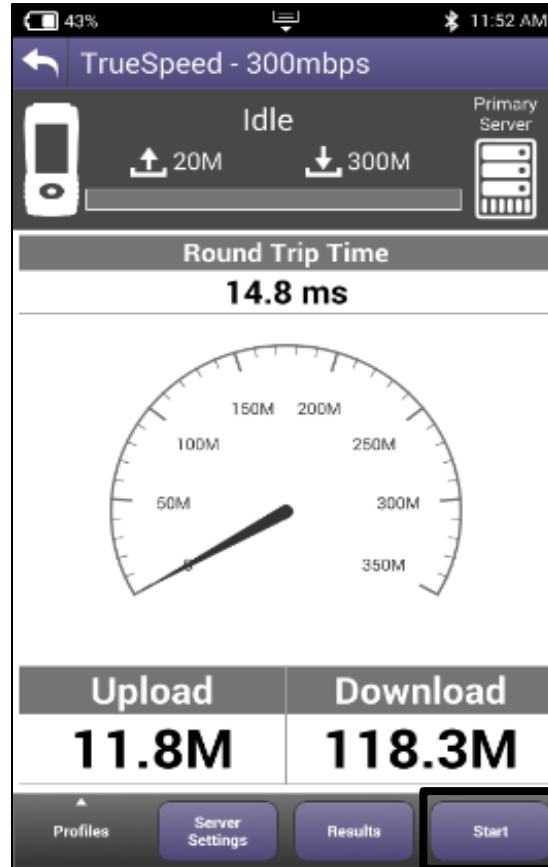

The list view displays the following information:

- Device status: 43% battery, 11:52 AM, Bluetooth on.
- Test name: TrueSpeed - 300mbps
- Current state: Idle
- Primary Server: [Server icon]
- Upload speed: 20M
- Download speed: 300M
- Table of results:

	Upload	Download
Actual Rate	11.8M	118.3M
Ideal Rate	19.0M	284.8M
TCP Efficiency	100.00 %	100.00 %
Server	142.129.0.65:8180	
RTT	14.8 ms	
MSS	1460	

Wiring Tools

WIRING TOOLS - Port Discovery

PORT DISCOVERY will allow the technician to verify capabilities of the ELECTRICAL ETHERNET port under test

Useful in determining if a customer's switch or router can handle higher speed



is test

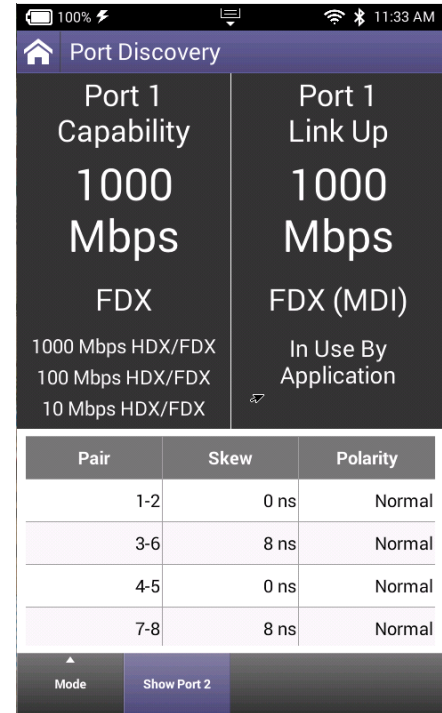

WIRING TOOLS - Hub Flash

HUB FLASH will allow the technician to “tone” out the ethernet on a far side router or switch using the cadence or speed of the port lights for identification



a
b
c

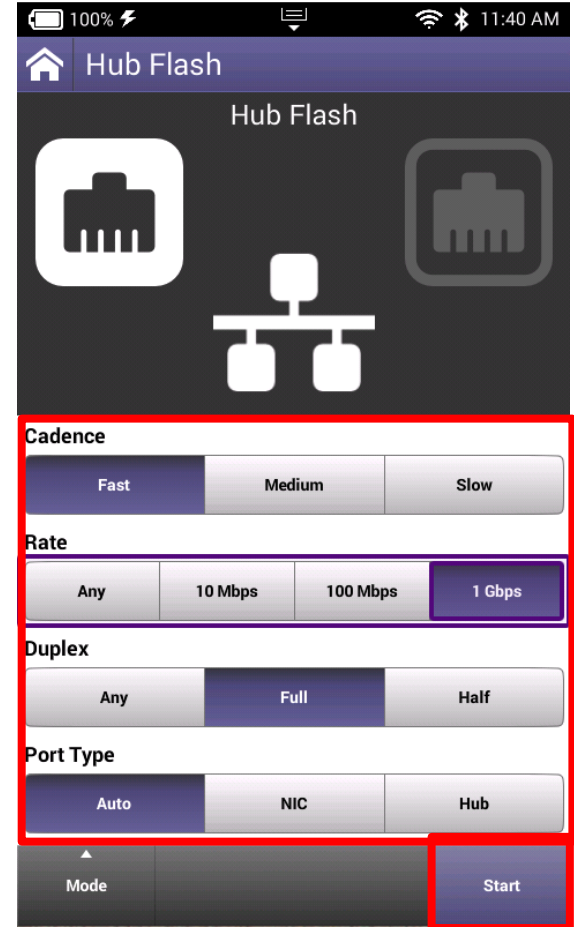

WIRING TOOLS - Ping Tool

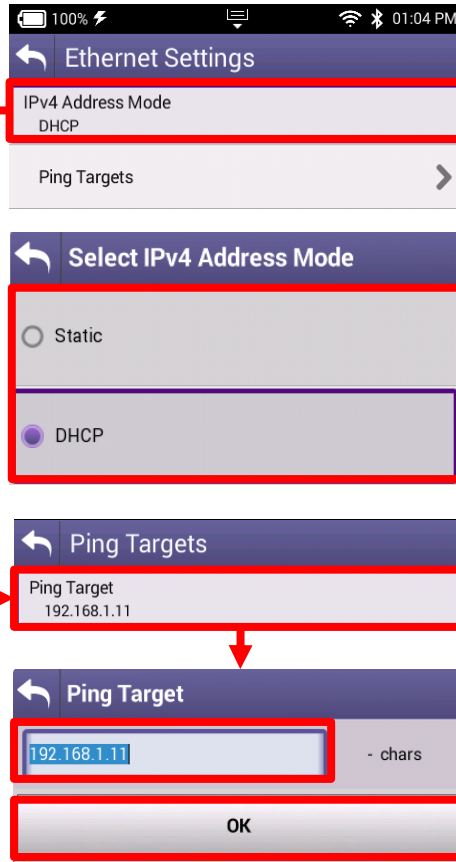
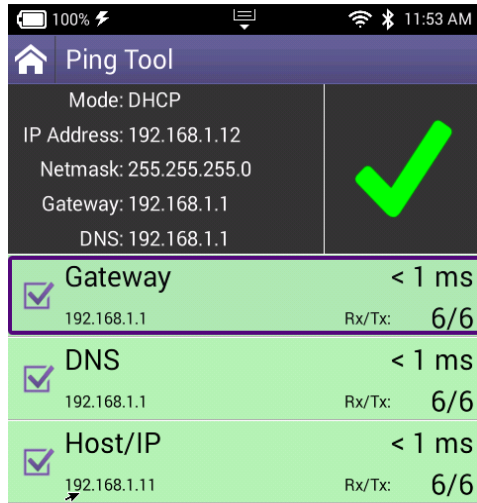

Fiber Optics

P5000i Fiber Microscope and MP-60/80 Optical Power Meter

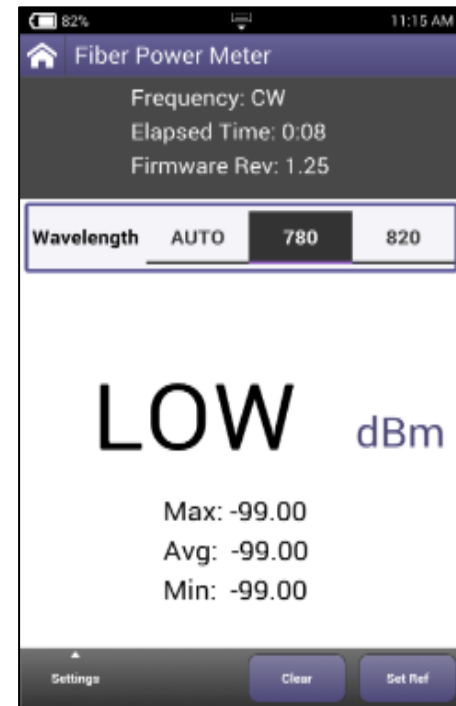

P5000i Probe Microscope

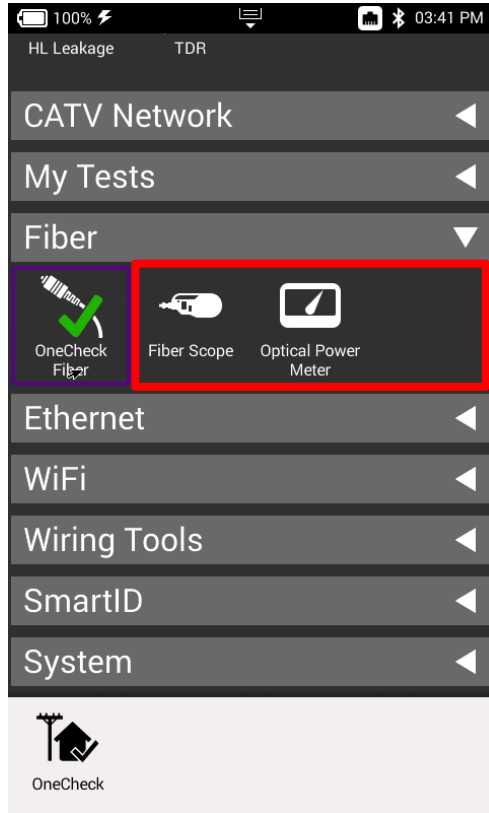

Quick Check

Quick Check

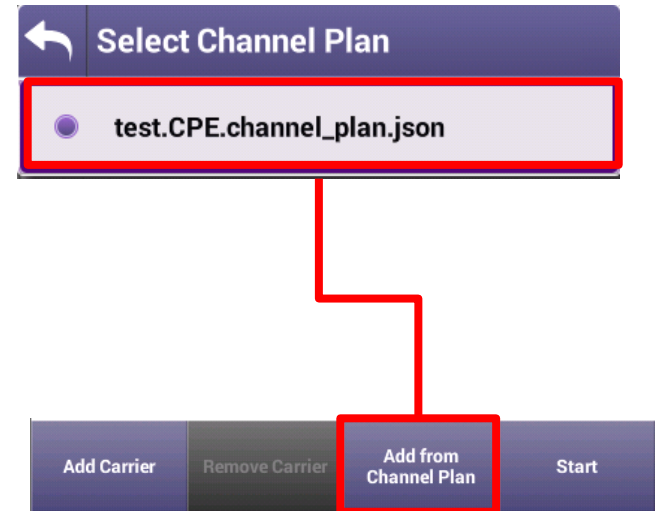
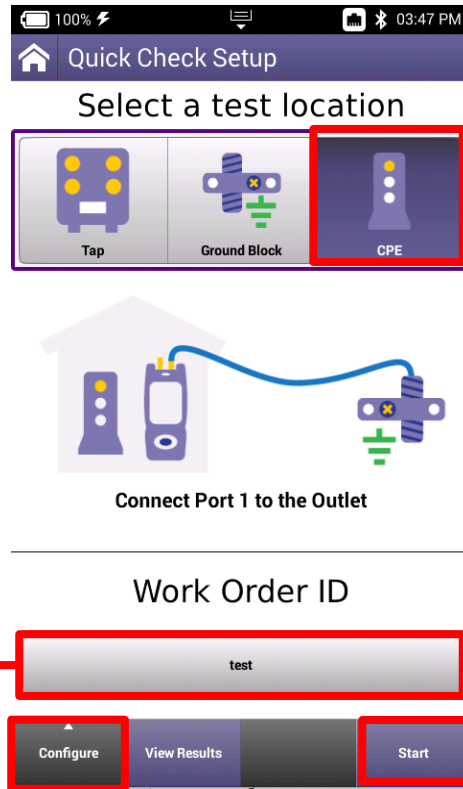
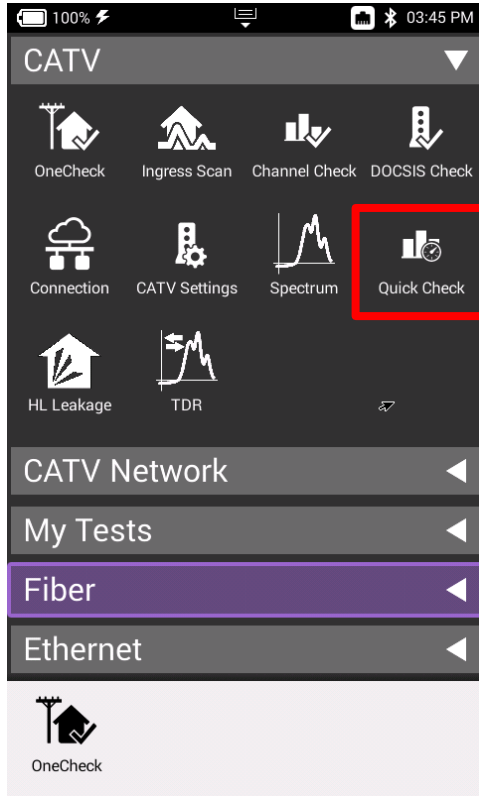

Quick Check

100% 03:55 PM

Add Carrier From Channel Plan

Channel Plan
test.CPE.channel_plan.json

Channels:

- CH 82 (579.000 MHz)
Digital - 256QAM - 6.000 MHz - 5.361 Msym/s
- CH 83 (579.000 MHz)
Digital - 256QAM - 6.000 MHz - 5.361 Msym/s
- CH 84 (585.000 MHz)
Digital - 256QAM - 6.000 MHz - 5.361 Msym/s
- CH 85 (591.000 MHz)
Digital - 256QAM - 6.000 MHz - 5.361 Msym/s
- CH 86 (597.000 MHz)
Digital - 256QAM - 6.000 MHz - 5.361 Msym/s
- CH 87 (603.000 MHz)
Digital - 256QAM - 6.000 MHz - 5.361 Msym/s
- CH 88 (609.000 MHz)
Digital - 256QAM - 6.000 MHz - 5.361 Msym/s
- CH 89 (615.000 MHz)
Digital - 256QAM - 6.000 MHz - 5.361 Msym/s
- CH 90 (621.000 MHz)
Digital - 256QAM - 6.000 MHz - 5.361 Msym/s

Apply

100% 05:57 PM

Quick Check

Tap Ground Block CPE

34 861.000 MHz | -10.5 dBmV
-2 481.000 MHz | Δ -7.9 dB

TOT: -3.9 dB

Freq (MHz)	Level (dBmV)
57.000	1.3
380.000	-2.6
861.000	-10.5

Save Display Stop

1.0 dB

2.0 dB

5.0 dB

10.0 dB

20.0 dB

Reference Now

Auto Reference

Δ Marker

Spectrum

Spectrum

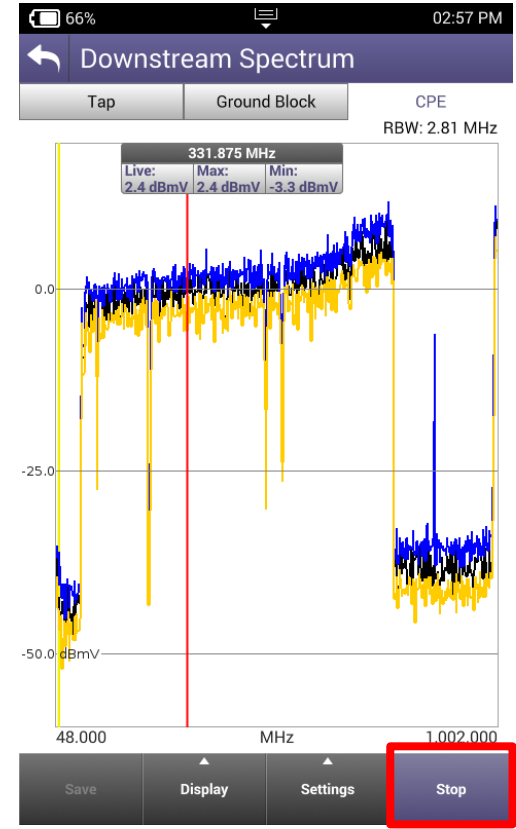
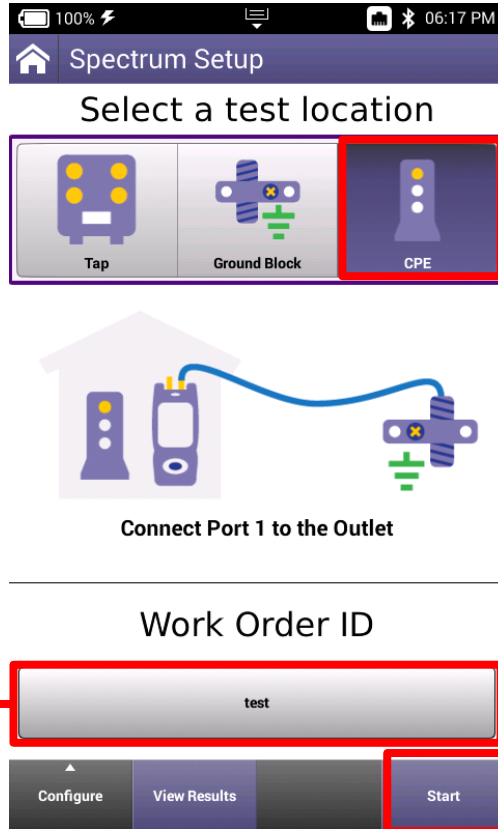
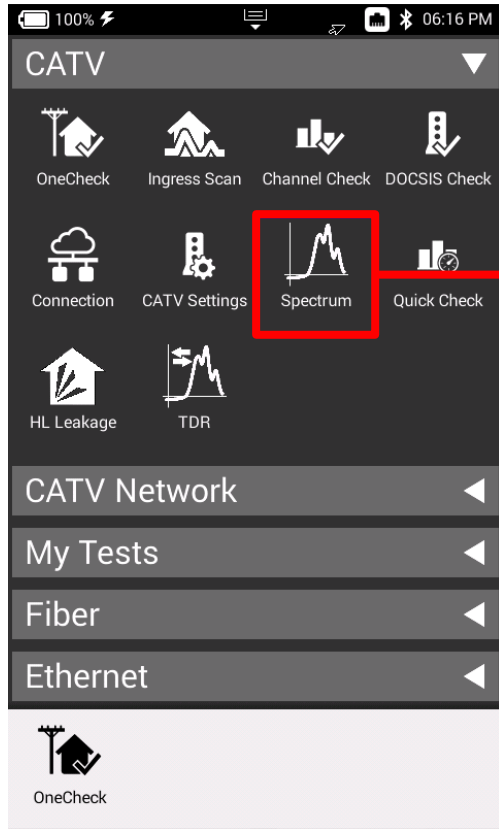

Spectrum

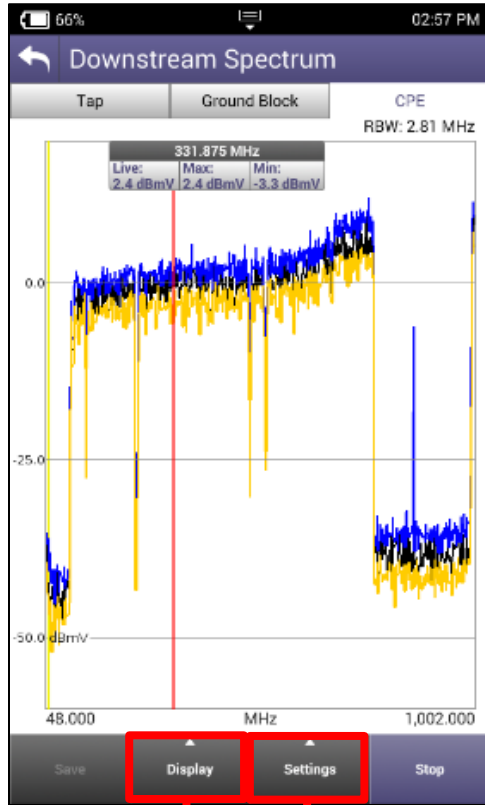

- Auto RBW
- RBW
2.81 MHz
- Auto AGC
- Re-AGC
- Reset Graph
- Set Diplexer

- Rotate Screen
Portrait
- dB/div
- Span Start and Stop Frequency
Start: 48.000 MHz Stop: 1,002.000 MHz
- Live trace
- Max trace
- Min trace

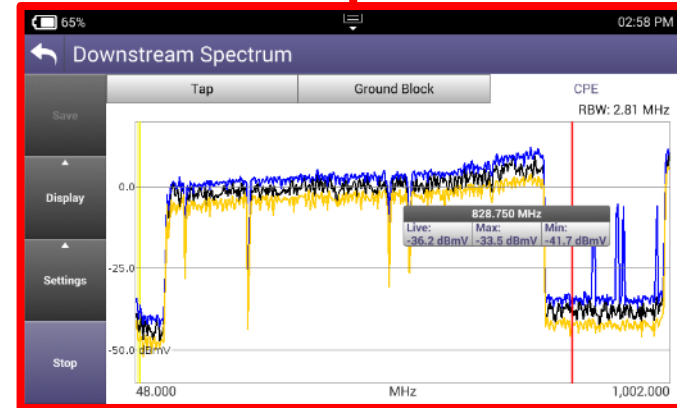

TDR

TDR

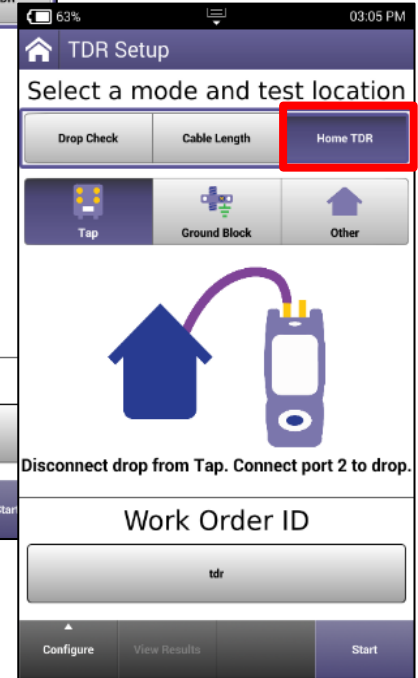
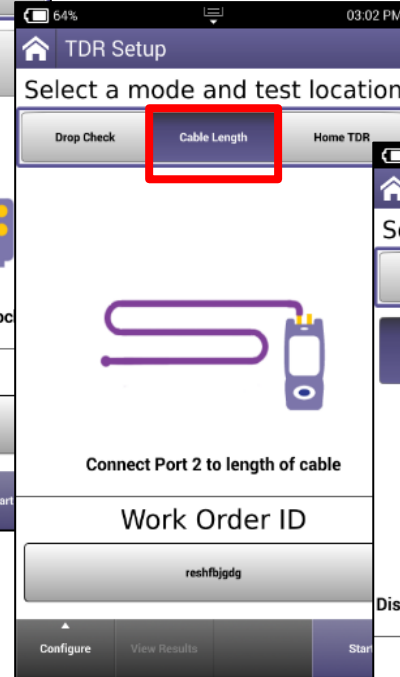
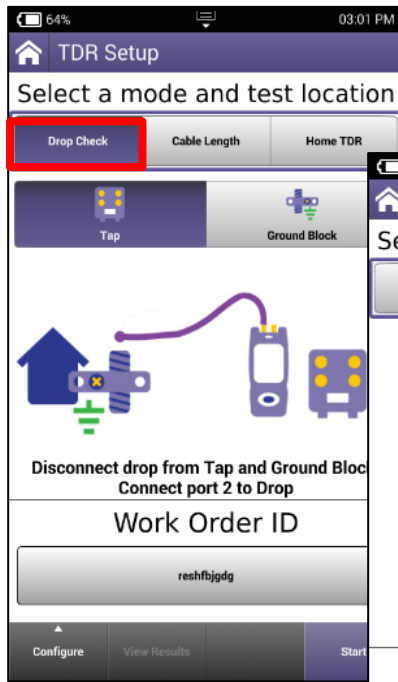
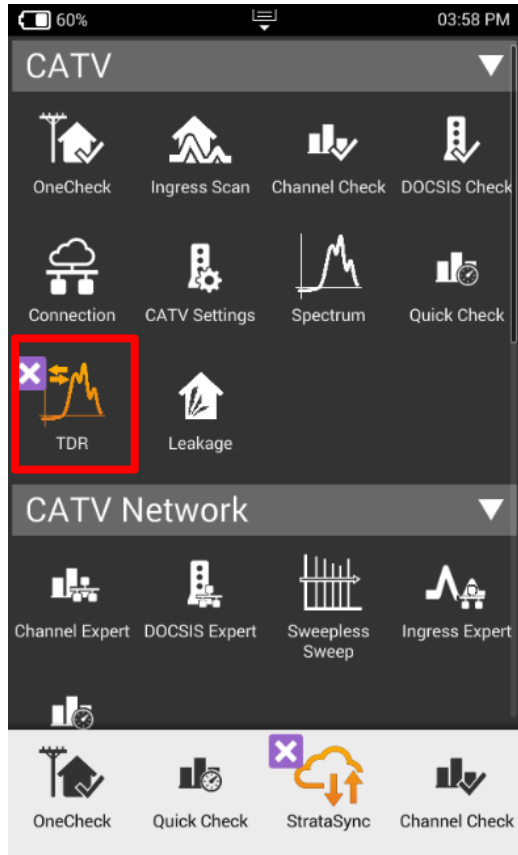

HOME TDR

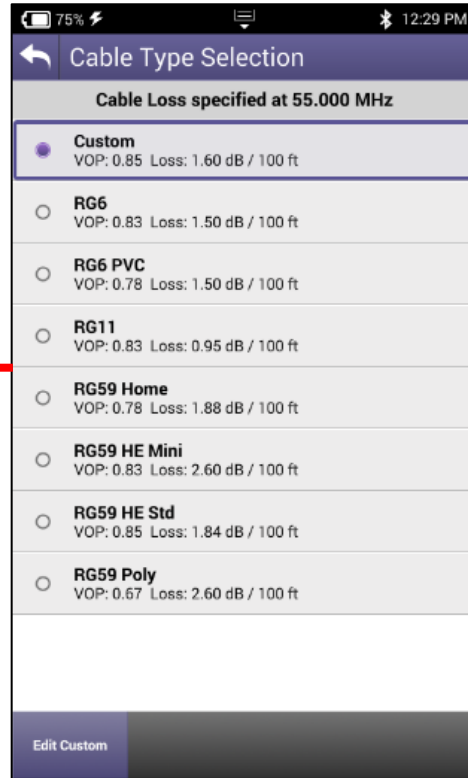
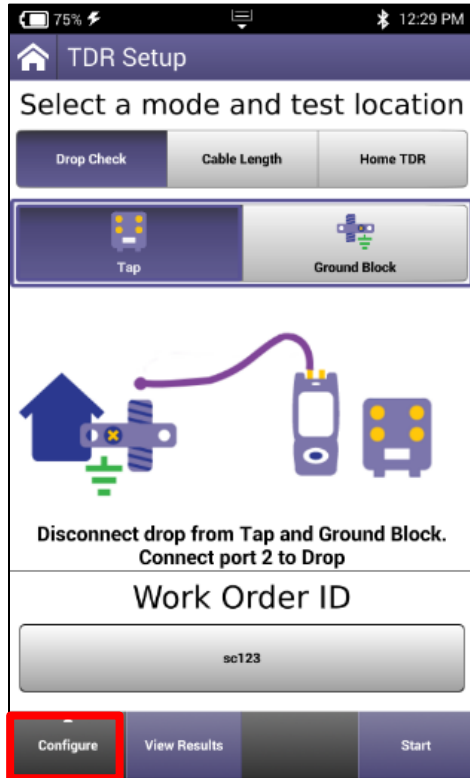

A TDR measures reflections based on time. Therefore the correct Velocity of Propagation for the cable to be tested must be chosen first.

VoP is essential for accurate distance measurements

TDR – DROP CHECK and CABLE LENGTH

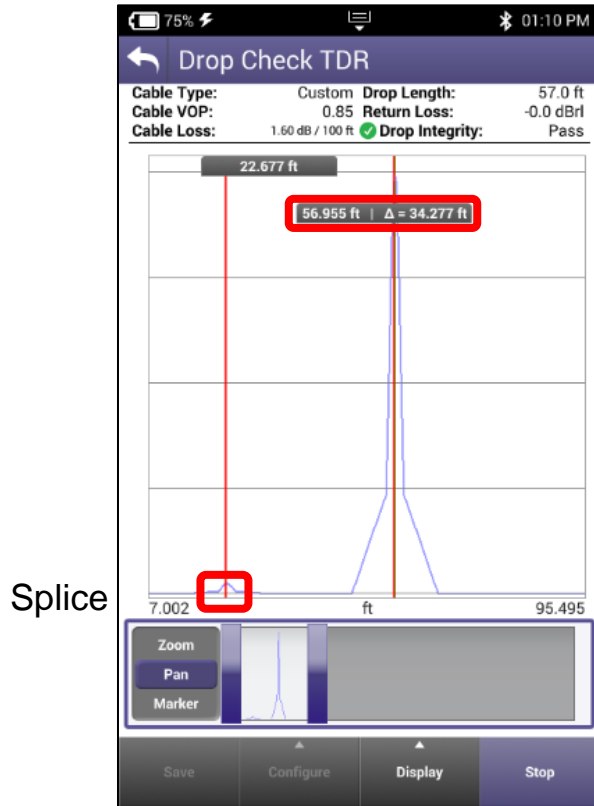

DROP CHECK and CABLE LENGTH tabs are identical tests. The DROP CHECK simply reminds the user to disconnect the other end of the drop.

Displayed is a 57' cable with a splice.

The splice is a small reflection at 22' while the open end of the cable is a larger reflection at 57'.

TDR - HOME TDR

HOME TDR test is designed to display splices, splits and cable lengths.

Example to the left still shows the splice at 22' with a splitter at 57' and 2 cables connected to the splitter with open ends.

HOME TDR displays all 4 events.

Markers can be added for relative distances under from the display button.

Horizontal Zoom and Pan functions are at the bottom of the display

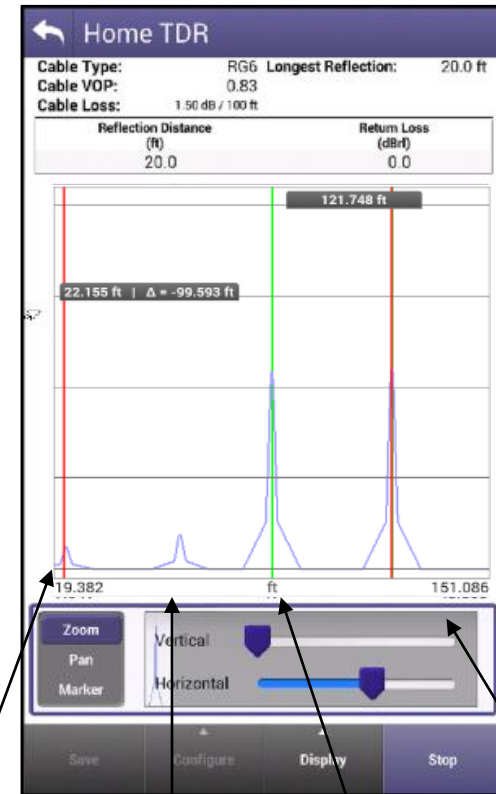

Splice

Splitter

Open

Open

TDR Mode-Drop Check Update

- New Ability to determine if reflection is a short or open
- Added a reflection table to the Drop Check mode to better understand what the ONX has discovered
 - Distance to reflection (ft)
 - Return Loss (dBrl)
 - Reflection Type (open/short)

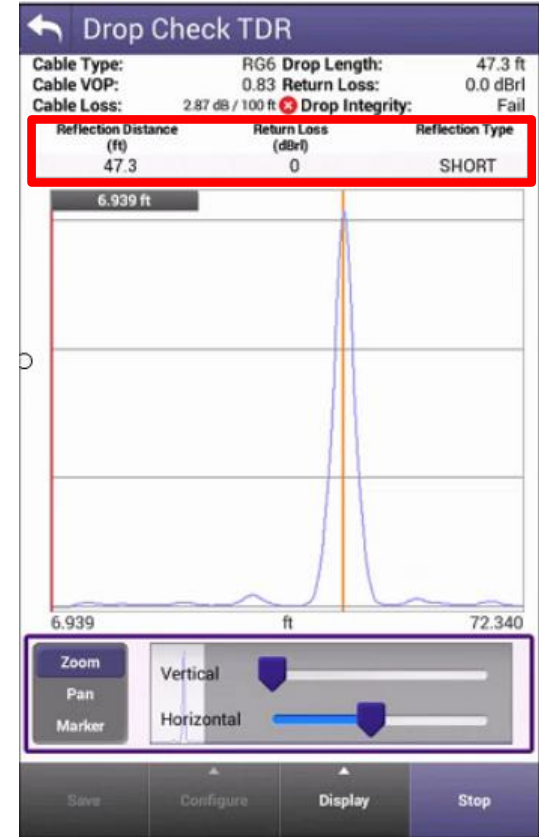
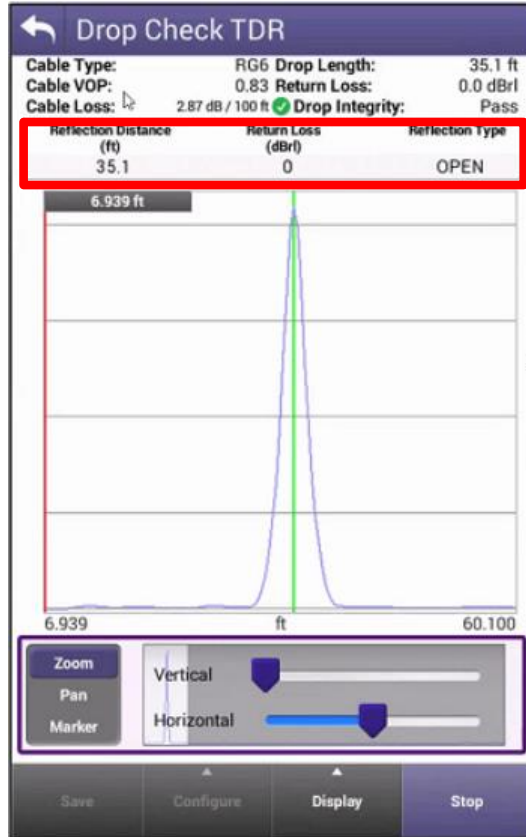

HL Leakage with Transmitter

HL Leakage with Transmitter

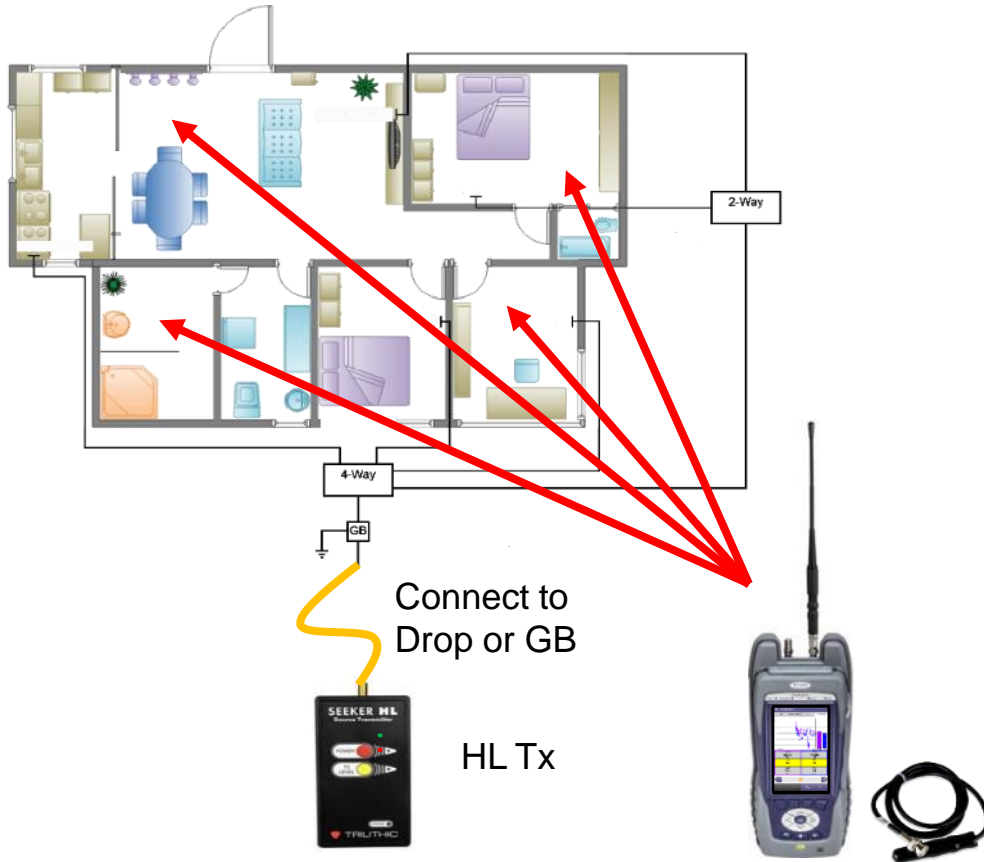

- Connect HL TRANSMITTER to GB or DROP and turn unit on.
- Proceed to attach ANTENNA to OneExpert CATV Port 1 and walk around the home or business
- Required Equipment Includes:
 - ONX-620 or ONX-630 with DOCSIS 3.1 hardware
 - HL Leakage software option must be present on the OneExpert CATV
 - HL Leakage Transmitter (60dBmv output [RED LIGHT] and 40dBmv output [GREEN LIGHT])
 - HL Leakage Antennas
 - 4a) Dual band rubber duck antenna
 - 4b) Near-Field Probe antenna
 - Used for detecting leaks when attached to OneExpert CATV
 - Tuned for 138MHz and 757.5MHz

HL Leakage with Transmitter

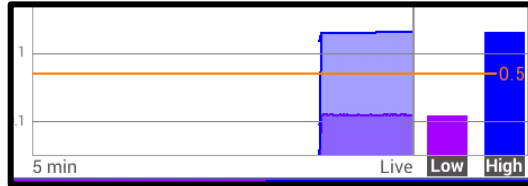
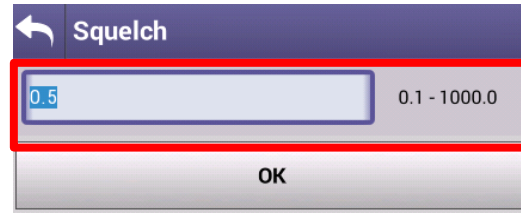
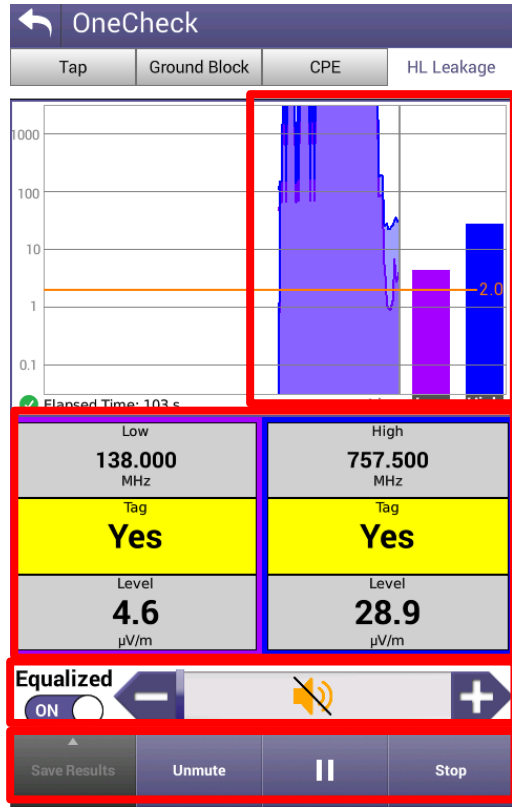

Leaks will be shown over time on the HL LEAKAGE display, while also emitting a siren that will signal proximity to leak

MUTE or UNMUTE and VOLUME controls as well as PAUSE and STOP/RETEST will be displayed across the bottom

Since HL Leakage is LIVE, select STOP before adjusting the SQUELCH limit

Ingress Scan

Ingress Scan

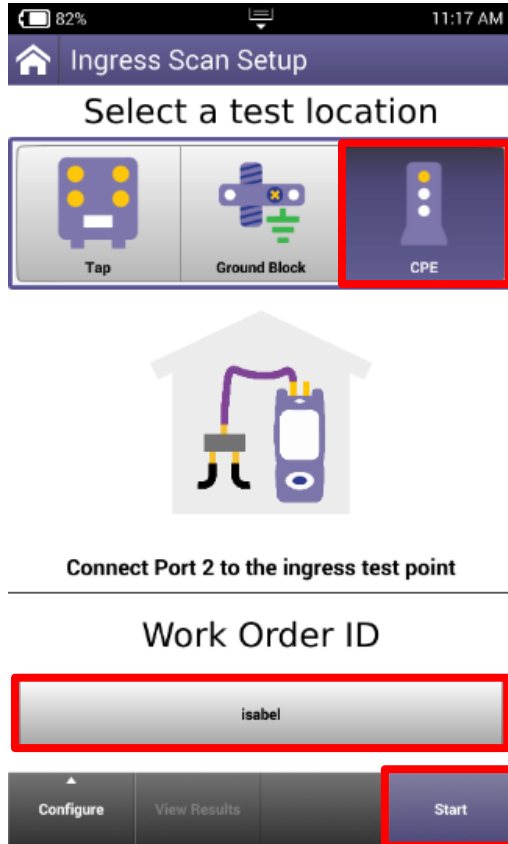

82% 11:17 AM

Ingress Scan Setup

Select a test location

Tap Ground Block CPE

Connect Port 2 to the ingress test point

Work Order ID

isabel

Configure View Results Start

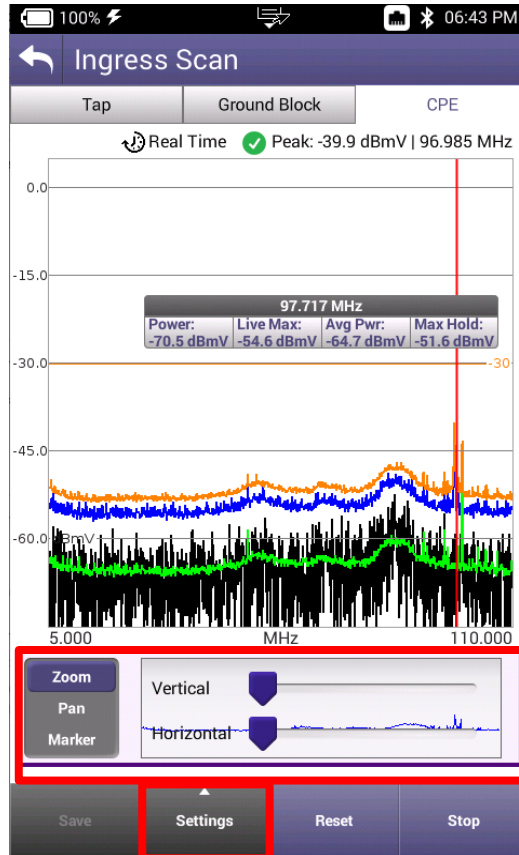

100% 06:43 PM

Ingress Scan

Tap Ground Block CPE

Real Time Peak: -39.9 dBmV | 96.985 MHz

Power:	Live Max:	Avg Pwr:	Max Hold:
-70.5 dBmV	-54.6 dBmV	-64.7 dBmV	-51.6 dBmV

5.000 110.000 MHz

Zoom Pan Marker

Vertical Horizontal

Save Settings Reset Stop

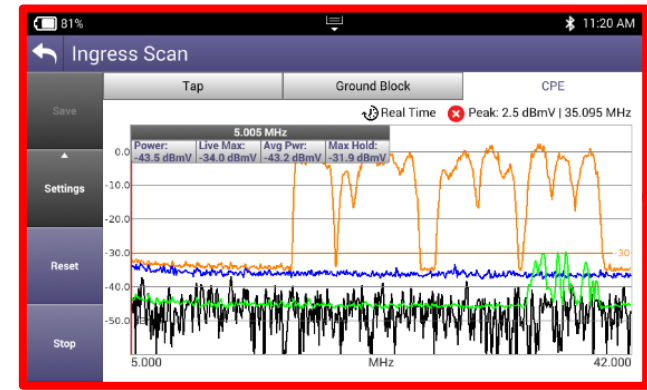

81% 11:20 AM

Ingress Scan

Tap Ground Block CPE

Real Time Peak: 2.5 dBmV | 35.095 MHz

Power:	Live Max:	Avg Pwr:	Max Hold:
-43.5 dBmV	-34.0 dBmV	-43.2 dBmV	-31.9 dBmV

5.000 42.000 MHz

Save Settings Reset Stop

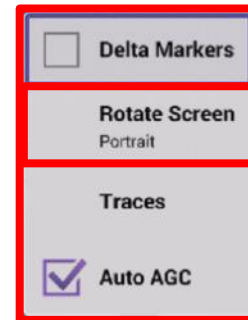

Delta Markers

Rotate Screen
Portrait

Traces

Auto AGC

Ingress Scan

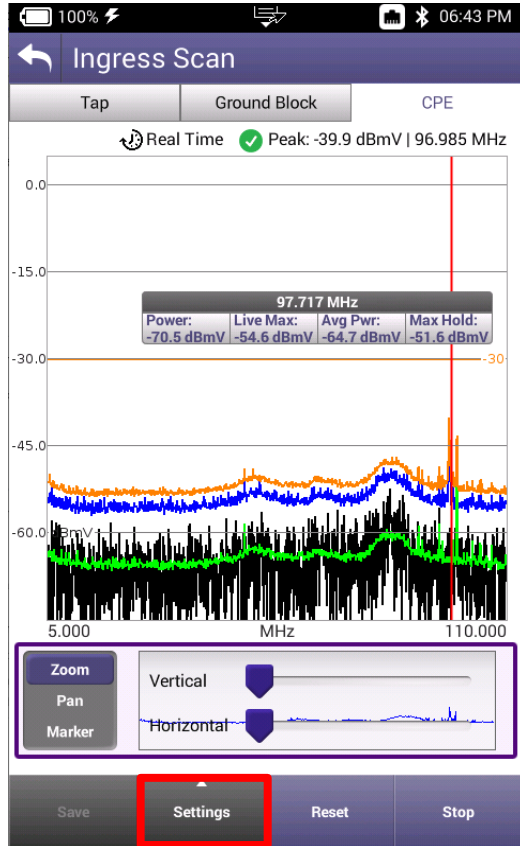

Delta Markers

Rotate Screen
Portrait

Traces

Auto AGC

Display Selection

Power

Average Power

Live Max

Max Hold

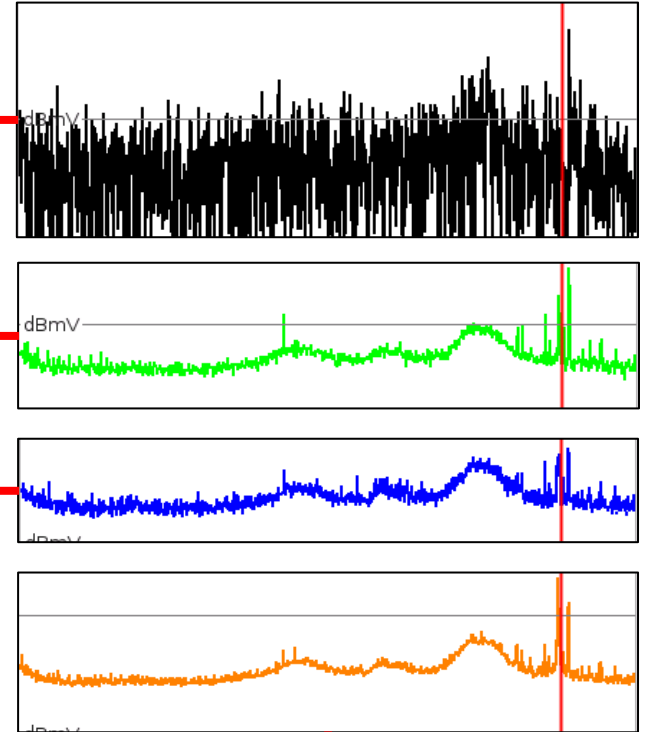

Channel Check

Channel Check

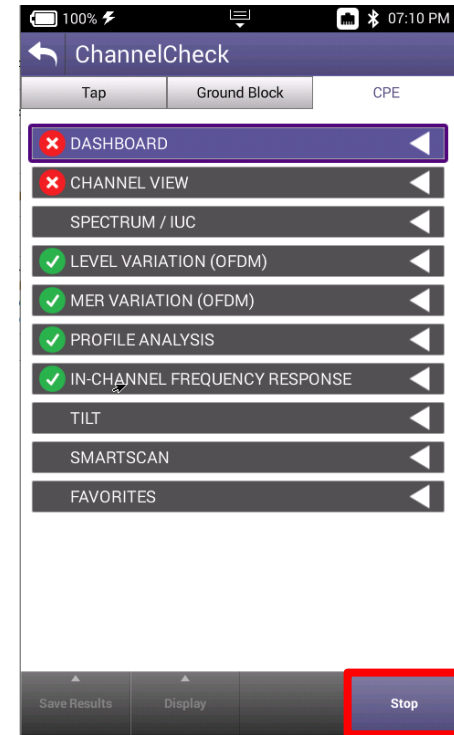
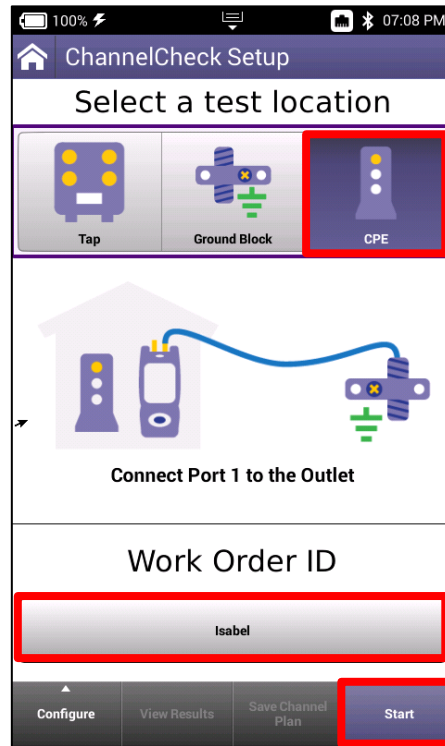
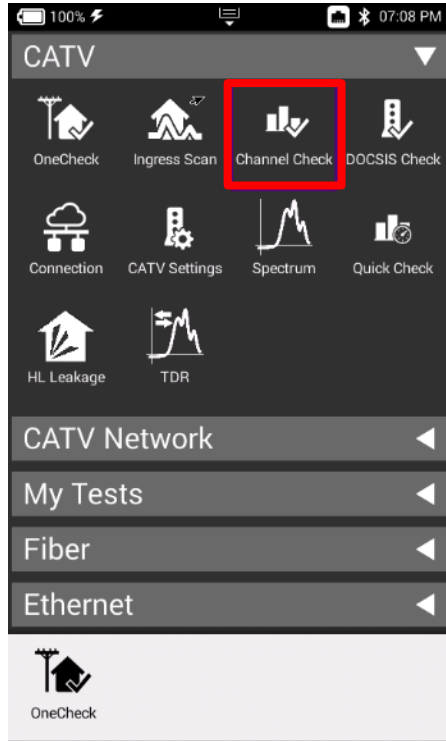

Channel Check

Channel	Freq (MHz)	Level (dBmV)	MER (dB)
37	303.000	-4.6	42.5
38	309.000	-4.7	42.5
39	315.000	-4.6	42.6
40	321.000	-4.6	42.5
OFDM 1	380.000	-3.2	--
70	499.250	3.4	--
74	525.000	-2.9	45.8
75	531.000	-3.1	45.8
76	537.000	-3.2	45.6

Channel	Freq (MHz)	Level (dBmV)	MER (dB)
PLC Level	-2.2 dBmV	PLC MER	41.8 dB
PLC CWE Corr	0.0	PLC CWE Uncorr	0.0
NCP CWE Corr	0.0	NCP CWE Uncorr	0.0
A CWE Corr	0.0	A CWE Uncorr	0.0
Level (Avg)	-3.2 dBmV	Level (Max)	-2.4 dBmV
Level (Min)	-3.7 dBmV	ICFR	0.8 dB
MER (Avg)	41.0 dB	MER (Std Dev)	0.6 dB
MER PCTL (2)	39.9 dB	Echo	-39.7 dBc

Channel Check

ChannelCheck

Tap Ground Block CPE

- DASHBOARD
- CHANNEL VIEW
- SPECTRUM / IUC
- LEVEL VARIATION (OFDM)
- MER VARIATION (OFDM)
- PROFILE ANALYSIS
- IN-CHANNEL FREQUENCY RESPONSE
- TILT
- SMARTSCAN
- FAVORITES

Save Results Display Stop

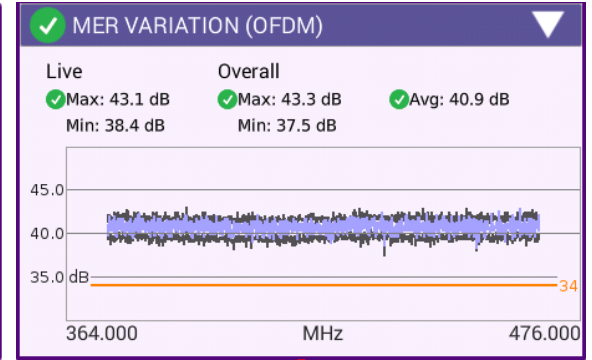
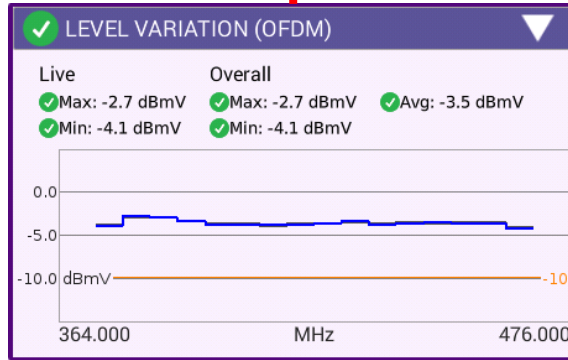
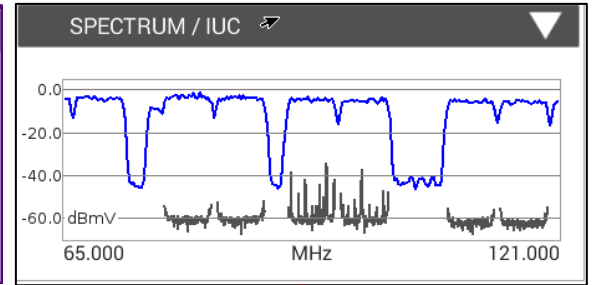
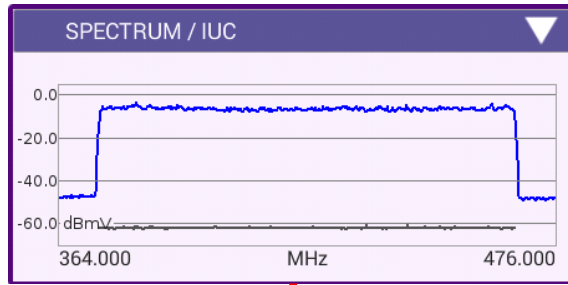

Channel Check

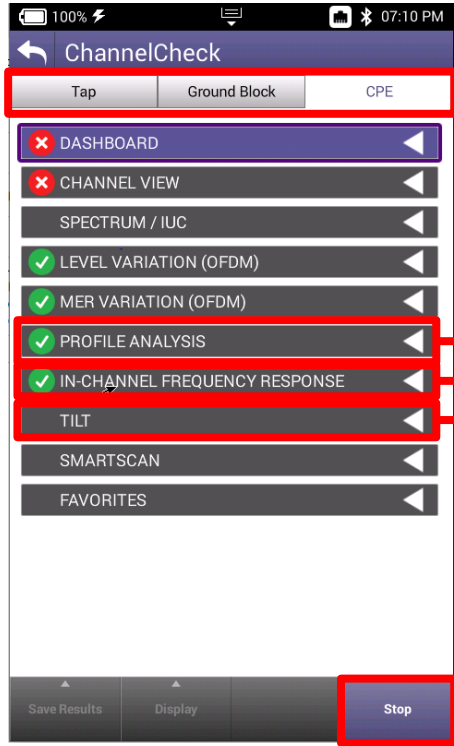

✓ PROFILE ANALYSIS

PROFILE	LOCKED	CWE (Corr)	CWE (Uncorr)	Max Mod
PLC	YES	0.0	0.0	16QAM
NCP	YES	0.0	0.0	16QAM
A	YES	0.0	0.0	256QAM
B	YES	0.0	0.0	1024QAM
C	YES	1.0e+0	0.0	4096QAM

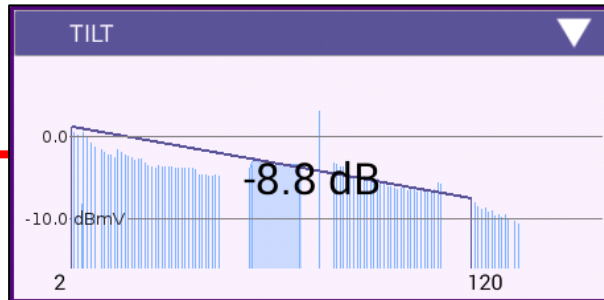
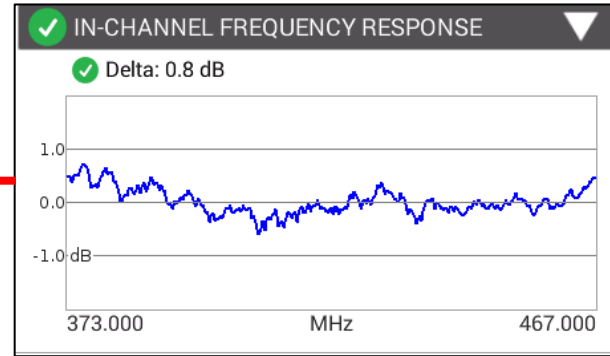

Channel Check

ChannelCheck

Tap Ground Block CPE

- DASHBOARD
- CHANNEL VIEW
- SPECTRUM / IUC
- LEVEL VARIATION (OFDM)
- MER VARIATION (OFDM)
- PROFILE ANALYSIS
- IN-CHANNEL FREQUENCY RESPONSE
- TILT
- SMARTSCAN
- FAVORITES
- CONSTELLATION

Save Results Display Stop

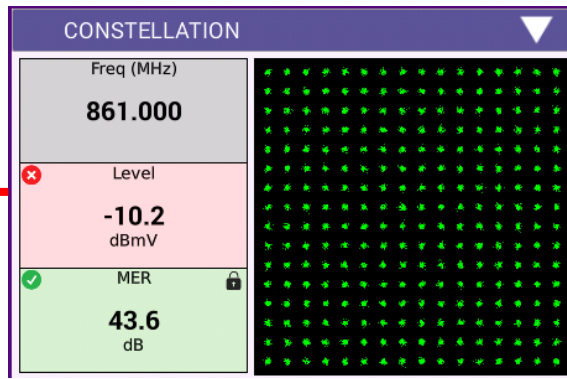
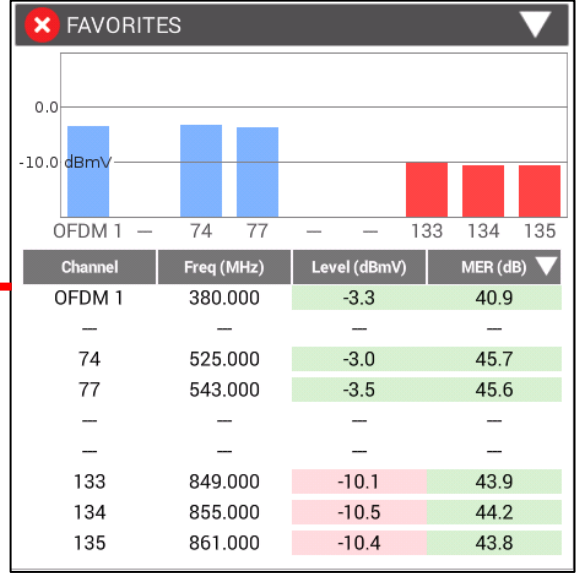
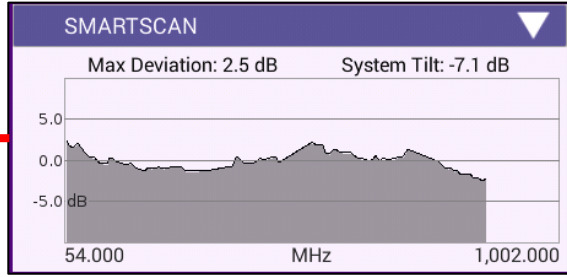

DOCSIS Check

DOCSIS Check

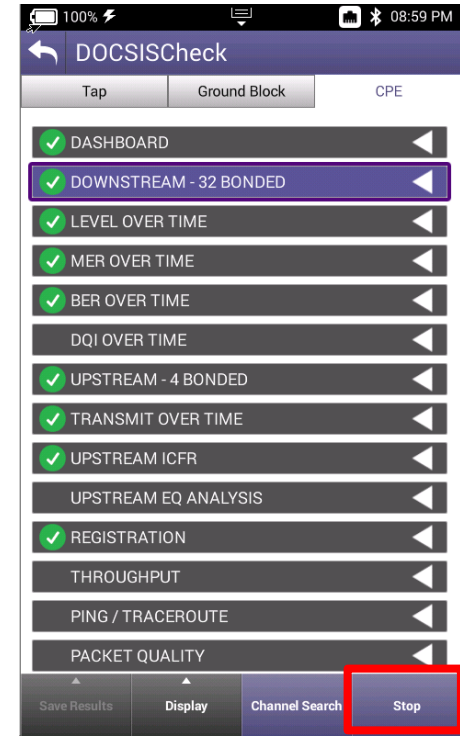
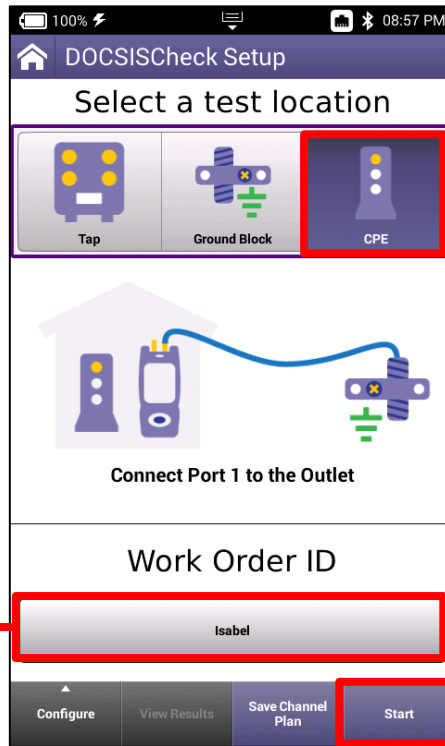
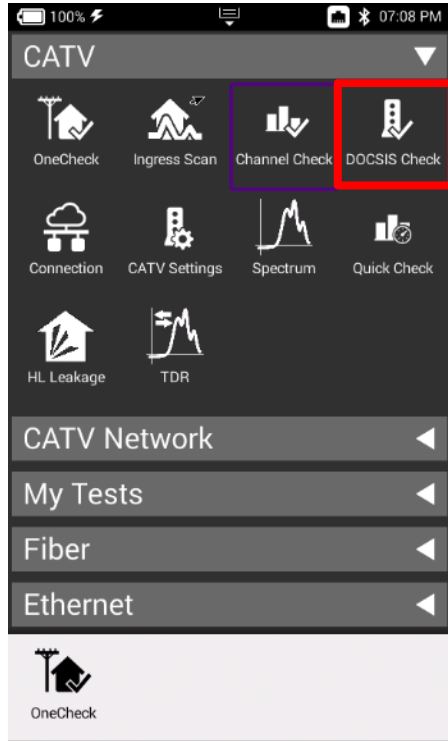

DOCSIS Check

DOCSISCheck

Tap Ground Block CPE

- ✓ DASHBOARD
- ✓ DOWNSTREAM - 32 BONDED
- ✓ LEVEL OVER TIME
- ✓ MER OVER TIME
- ✓ BER OVER TIME
- DQI OVER TIME
- ✓ UPSTREAM - 4 BONDED
- ✓ TRANSMIT OVER TIME
- ✓ UPSTREAM ICFR
- UPSTREAM EQ ANALYSIS
- ✓ REGISTRATION
- THROUGHPUT
- PING / TRACEROUTE
- PACKET QUALITY

Save Results Display Stop

Channel	Freq (MHz)	Level (dBmV)	MER (dB)
103	669.000	-6.1	44.3
104	675.000	-6.3	44.6
105	681.000	-6.2	44.6
106	687.000	-6.3	44.2
107	693.000	-6.0	44.6
108	699.000	-6.2	44.6
109	705.000	-6.0	44.5

✓ DASHBOARD

✓ DOCSIS (100 %) Status: Connected

32x (1x OFDM) | Downstream

Min Rx: -6.3 dBmV Min MER: 38.1 dB
Max BER: 1.0e-9 (pre) Max MER: 45.9 dB

Upstream | 4x

Max Tx: 44.8 dBmV Max ICFR: 1.4 dB

✓ DOWNSTREAM - 32 BONDED

Spectrum Plot: -5.0 to -15.0 dBmV vs 54.000 to 750.000 MHz

Channel Metrics Table:

Level (dBmV)	MER (dB)	BER (Pre)	BER (Post)
-6.0	44.6	1.0e-9	1.0e-9
-35.5	36	0.7	10.0

Channel Freq (MHz) Level (dBmV) MER (dB)

DOCSIS Check

100% 09:01 PM

DOCSISCheck

Tap Ground Block CPE

- ✓ DASHBOARD
- ✓ DOWNSTREAM - 32 BONDED
- ✓ LEVEL OVER TIME
- ✓ MER OVER TIME
- ✓ BER OVER TIME
- DQI OVER TIME
- ✓ UPSTREAM - 4 BONDED
- ✓ TRANSMIT OVER TIME
- ✓ UPSTREAM ICFR
- UPSTREAM EQ ANALYSIS
- ✓ REGISTRATION
- THROUGHPUT
- PING / TRACEROUTE
- PACKET QUALITY

Save Results Display Stop

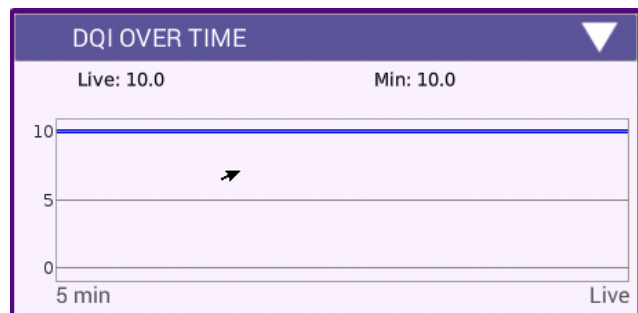
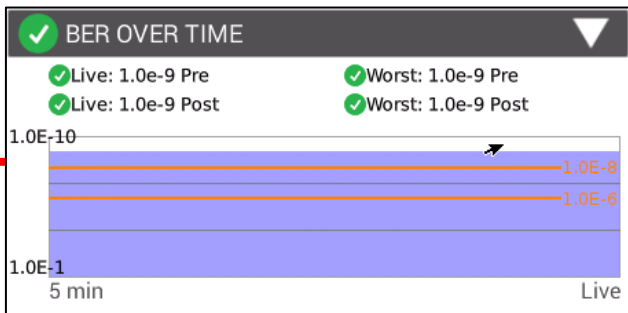
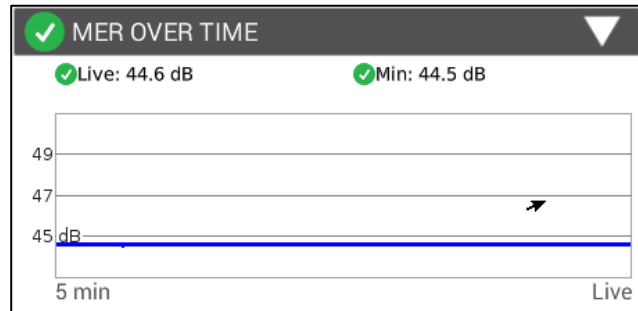
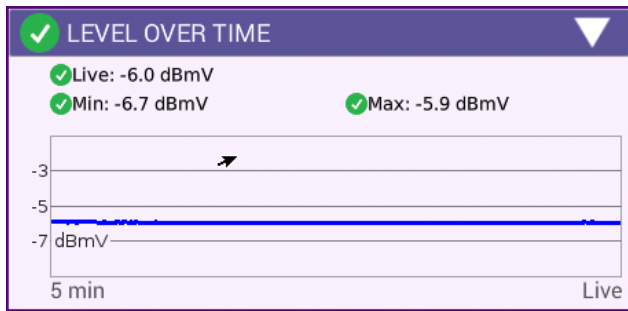

DOCSIS Check

100% 09:01 PM

DOCSISCheck

Tap Ground Block CPE

- ✓ DASHBOARD
- ✓ DOWNSTREAM - 32 BONDED
- ✓ LEVEL OVER TIME
- ✓ MER OVER TIME
- ✓ BER OVER TIME
- ✓ DQI OVER TIME
- ✓ UPSTREAM - 4 BONDED
- ✓ TRANSMIT OVER TIME
- ✓ UPSTREAM ICFR
- UPSTREAM EQ ANALYSIS
- ✓ REGISTRATION
- THROUGHPUT
- PING / TRACEROUTE
- PACKET QUALITY

Save Results Display Stop

✓ UPSTREAM - 4 BONDED

49.8
43.1
36.5 dBmV

17.800 MHz
64 QAM | 6.400 MHz | ATDMA

✓ TX Level	✓ ICFR
41.5 dBmV	1.3 dB

UCD	Freq (MHz)	Level (dBmV)	ICFR (dB)
9	17.800	41.5	1.3
10	24.200	42.8	1.2
11	30.600	43.5	1.3
12	37.000	44.8	1.1

✓ TRANSMIT OVER TIME

✓ Live: 42.8 dBmV
✓ Min: 42.8 dBmV
✓ Max: 43.3 dBmV

46
44
42 dBmV

5 min Live

✓ UPSTREAM ICFR

Reference bandwidth: Modem Default

46
44
42 dBmV

12.000 MHz 42.000

UPSTREAM EQ ANALYSIS

-10.0
-20.0
-30.0
-40.0
-50.0
-60.0
-70.0 dBc

Channel:	EQ Tap:
Frequency: 17.800 MHz	Time: -1.37 μ s
TX Level: 41.5 dBmV	Level: -54.2 dBc
Bandwidth: 6.4 MHz	Distance: 558.1 ft
	VOP: 0.830

DOCSIS Check

The main menu of the DOCSISCheck app. At the top, there are tabs for 'Tap', 'Ground Block', and 'CPE'. Below these are several menu items, each with a green checkmark icon and a right-pointing arrow. The items are: DASHBOARD, DOWNSTREAM - 32 BONDED, LEVEL OVER TIME, MER OVER TIME, BER OVER TIME, DQI OVER TIME, UPSTREAM - 4 BONDED, TRANSMIT OVER TIME, UPSTREAM ICFR, UPSTREAM EQ ANALYSIS, REGISTRATION, THROUGHPUT, PING / TRACEROUTE, and PACKET QUALITY. At the bottom, there are three buttons: 'Save Results', 'Display', and 'Stop'.

The REGISTRATION screen displays the following information:

- Service Plan:** -00:07:11:14:1B:CF
- Config File:** 7BEWgIyYABxEUg88KIsDi@CILA4mV4eXC2hq4Y+bmTGm.ZJKTLYf9
- Cable Modem:**
 - Provisioning Mode: IPv4 ONLY
 - IPv4 Address: 10.34.192.226
 - IPv4 Gateway Address: 10.34.192.1
 - IPv4 Subnet Mask: 255.255.224.0
 - IPv4 Config File: 7BEWgIyYABxEUg88KIsDi@CILA4mV4eXC2hq4Y+bmTGm.ZJKTLYf9
- CPE:**
 - IPv4 Address: 76.175.15.154
 - IPv4 Subnet Mask: 255.255.240.0
 - IPv4 Gateway Address: 76.175.0.1
- Servers:**
 - IPv4 TFTP Server: 98.150.3.166
 - IPv4 DHCP Server: 142.254.177.41
 - IPv4 TDD Server: 98.150.3.166

The THROUGHPUT screen displays the following information:

- THROUGHPUT (100 %)**
- Downstream URL:** http://spt01mtpkca.mtpk.ca.charter.com/mtpkr2D2wh3reRuN0w.iso
- Upstream URL:** http://spt01mtpkca.mtpk.ca.charter.com/mtpkr2D2wh3reRuN0w.iso
- Receive:** 1.19 Gbps, RTT: 19 ms
- Send:** 42.30 Mbps, RTT: 19 ms
- Two speedometer gauges for Receive and Send.
- Buttons: 'Configure' and 'Start Throughput'.

The PING / TRACEROUTE screen displays a table with the following columns: Current, Minimum, Average, and Maximum. The rows are: Delay (ms), Destination, Echoes Sent, Replies Returned, Replies Lost, Replies Lost %, and Error. The 'Delay (ms)' row shows dashes in all columns. Below the table is an 'Open Ping' button.

	Current	Minimum	Average	Maximum
Delay (ms)	-	-	-	-
Destination				
Echoes Sent				-
Replies Returned				-
Replies Lost				-
Replies Lost %				-
Error				-

The PACKET QUALITY screen displays the following information:

- Packet Loss:** 299 Sent, 0.0 % Loss
- Max Round Trip Delay:** 26 ms
- Max Jitter:** 19 ms (highlighted in yellow)
- Buttons: 'Stop Packet Quality' and 'Start Pass Through Cable Modem'.

One Check

One Check

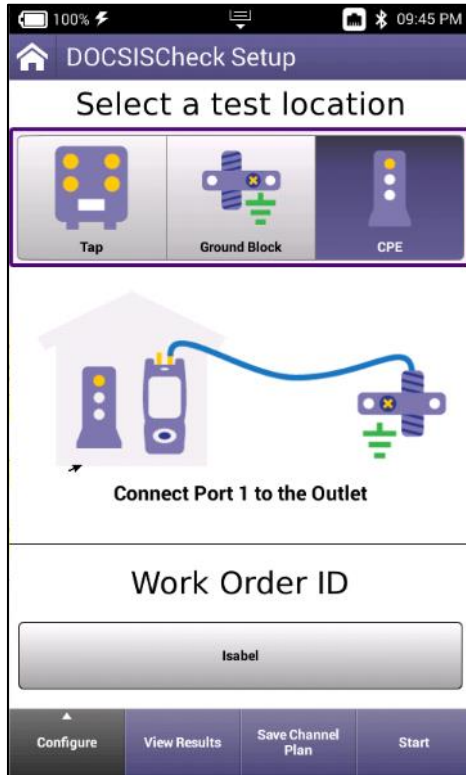

One Check without HL Leakage Requirement (Default)

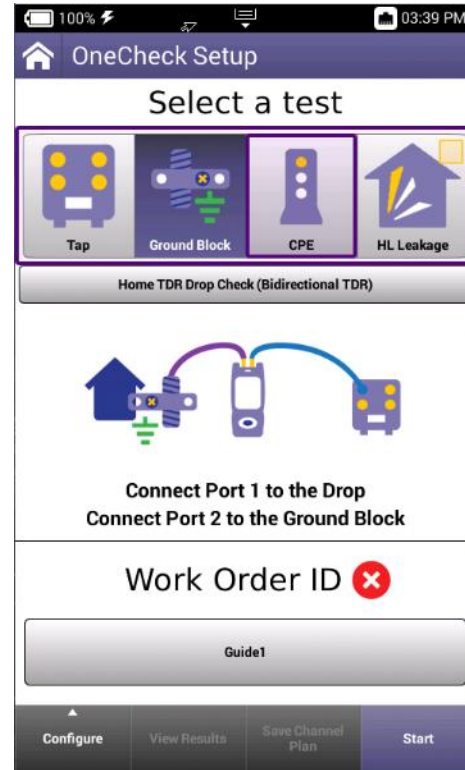

One Check with HL Leakage Requirement

One Check

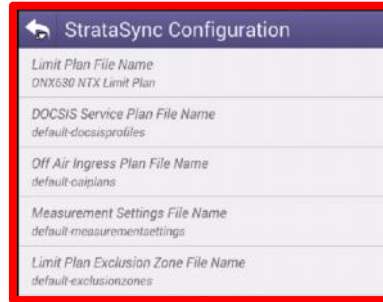
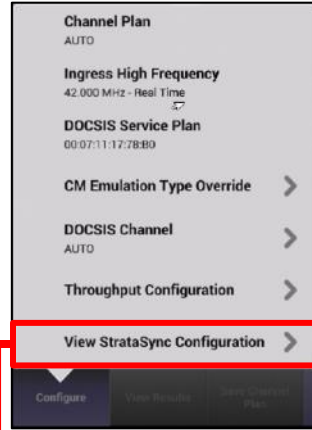
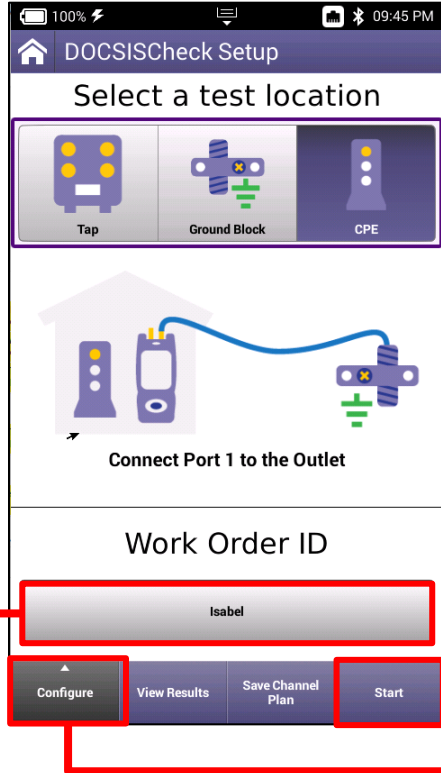

User can verify that configurations are correct and up to date by selecting VIEW STRASYNC CONFIGURATION

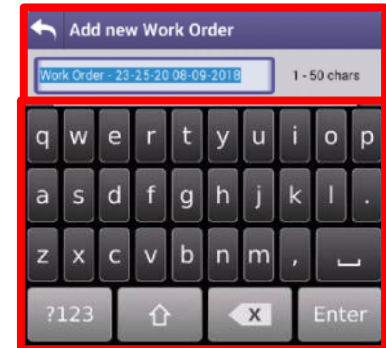
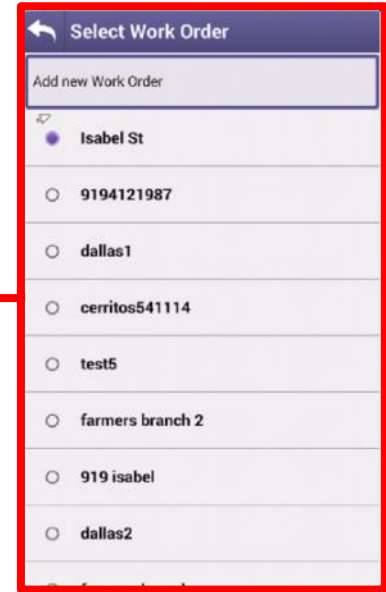

One Check

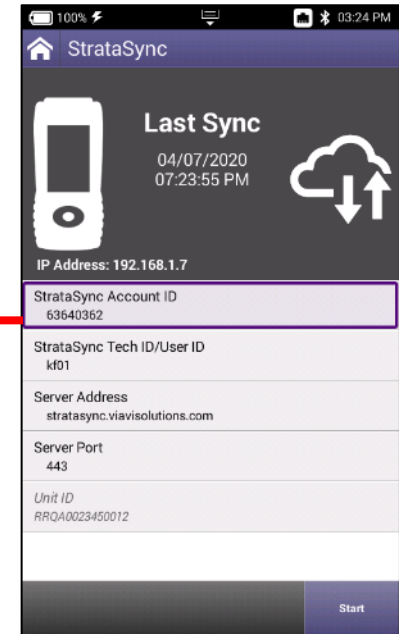
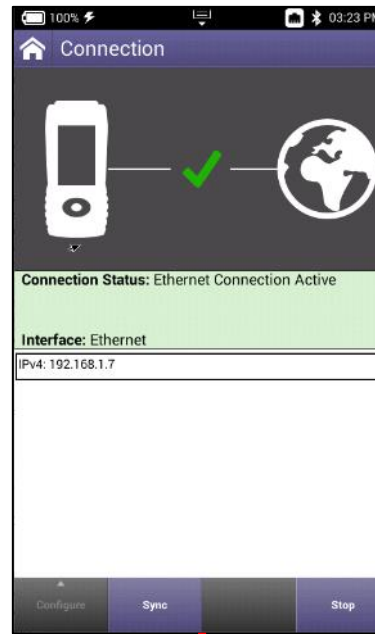
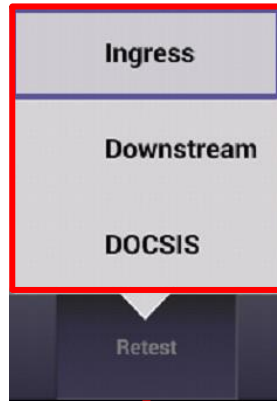
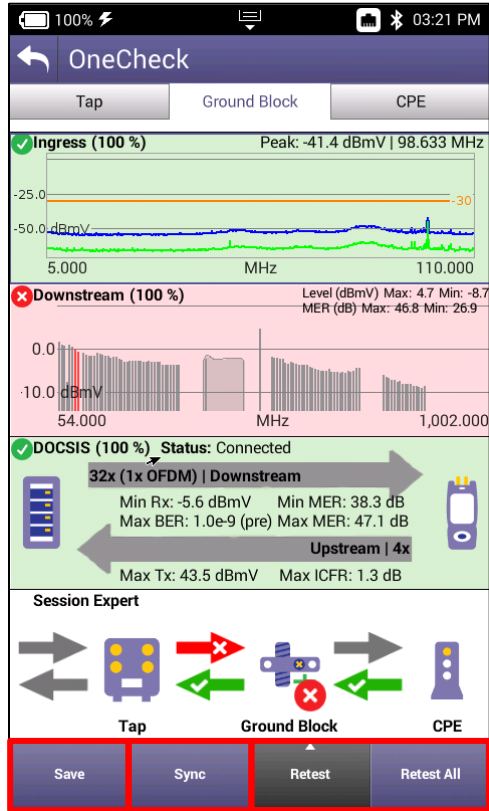

The 'Save File Name' dialog box has a text input field containing 'GB Fail' and a character count '1 - 50 chars'. A 'Save' button is located at the bottom of the dialog.

One Check - Ingress

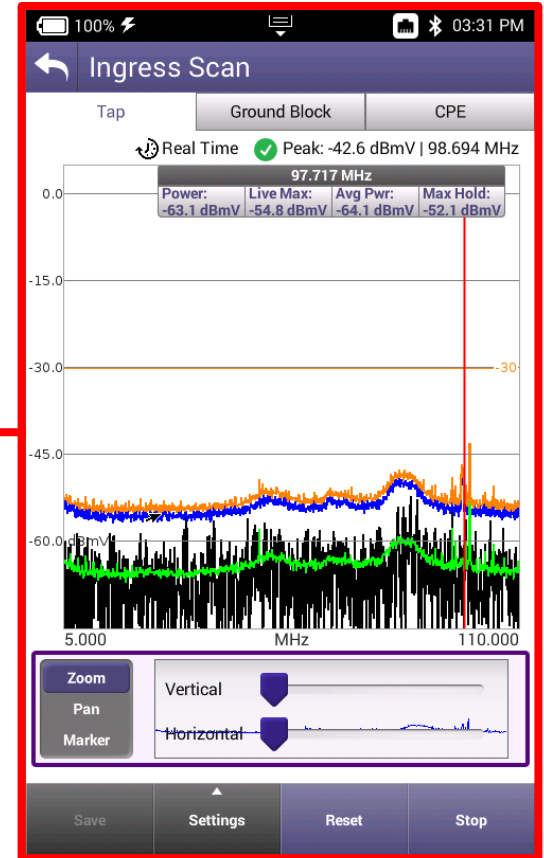
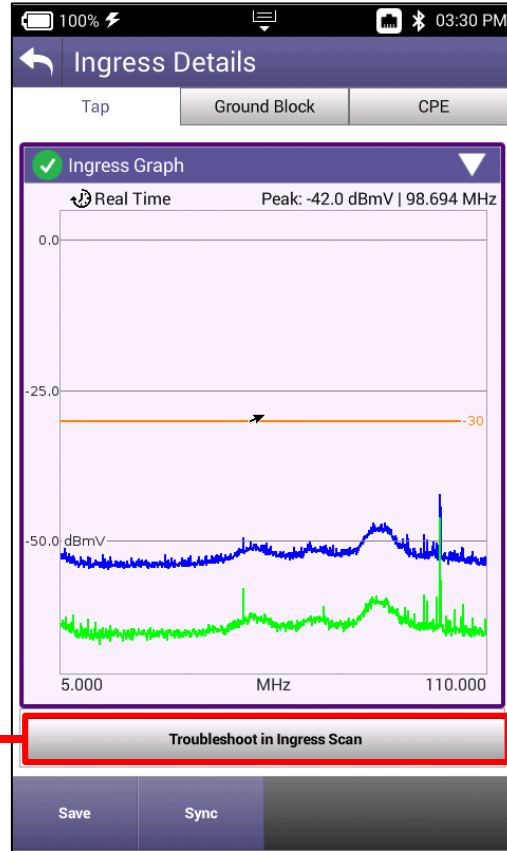
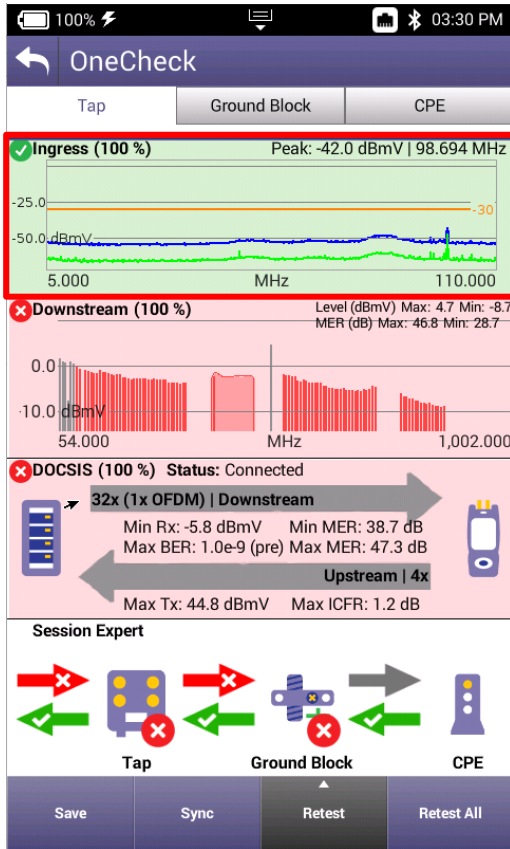

One Check - Downstream

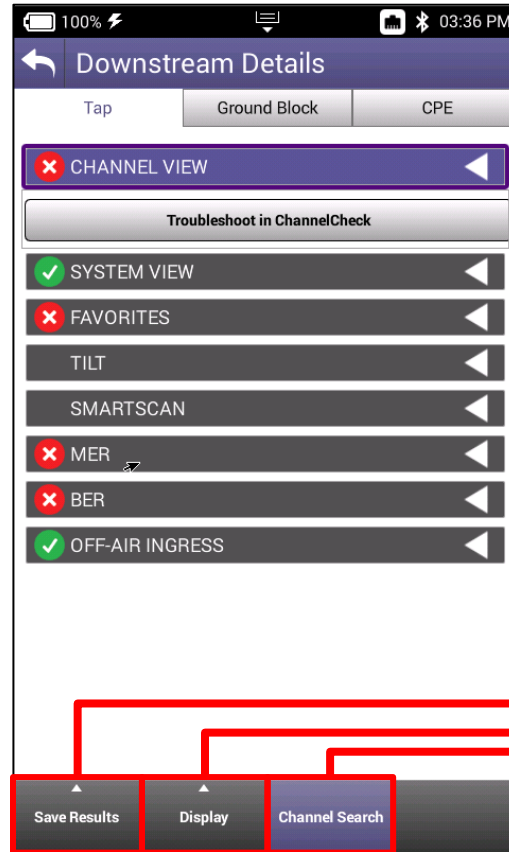
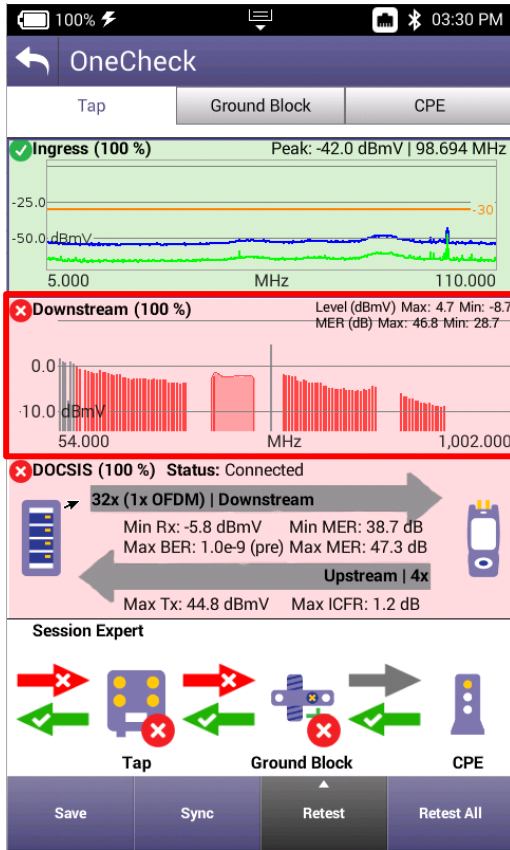

Save
Sync

Search Channel

Search by Channel Number

Search by Channel Frequency

OK

1.0 dB
2.0 dB
5.0 dB
10.0 dB
20.0 dB

Auto Reference

One Check - Downstream

Downstream Details

Tap Ground Block CPE

CHANNEL VIEW

Troubleshoot in ChannelCheck

SYSTEM VIEW

FAVORITES

TILT

SMARTSCAN

MER

BER

OFF-AIR INGRESS

Save Results Display Channel Search

SYSTEM VIEW

Max	Max
13.4 dB	--- dB
dB Delta	Video Delta

FAVORITES

Channel	Freq (MHz)	Level (dBmV)	MER (dB)
OFDM 1	380.000	-2.1	41.9
74	525.000	-1.7	46.7
77	543.000	-2.1	46.5
133	849.000	-8.5	42.8
134	855.000	-8.7	43.3
135	861.000	-8.5	43.2

CHANNEL VIEW

Annex B | 256 QAM | 5.361 Msym/s | 6.000 MHz

Level	MER	BER Pre	BER Post
-8.5 dBmV	43.2 dB	1.0e-8	1.0e-8
Echo	GD	ICFR	Hum
-32.1 dBc	56 ns	0.8 dB	0.1 %

Channel	Freq (MHz)	Level (dBmV)	MER (dB)
131	837.000	-8.4	43.5
132	843.000	-8.5	43.8
133	849.000	-8.5	42.8
134	855.000	-8.7	43.3
135	861.000	-8.5	43.2

One Check - Downstream

100% 03:36 PM

Downstream Details

Tap Ground Block CPE

- CHANNEL VIEW
- SYSTEM VIEW
- FAVORITES
- TILT
- SMARTSCAN
- MER
- BER
- OFF-AIR INGRESS

Save Results Display Channel Search

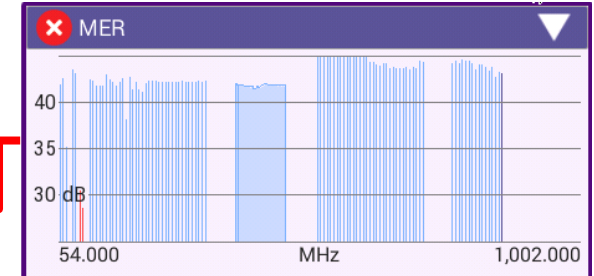
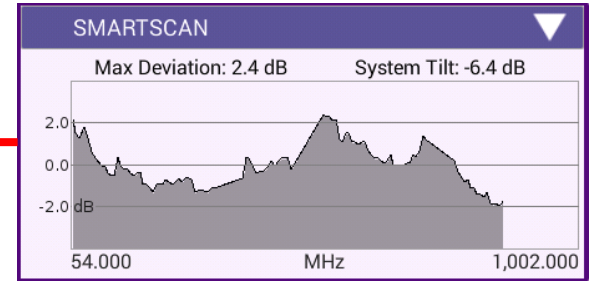
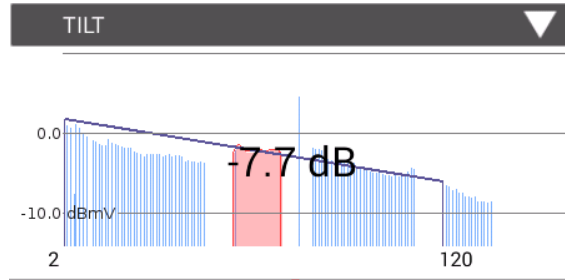

OFF-AIR INGRESS

Name	Peak (MHz)	Peak (dBmV)
Default Ingress Span	731.988	-47.4

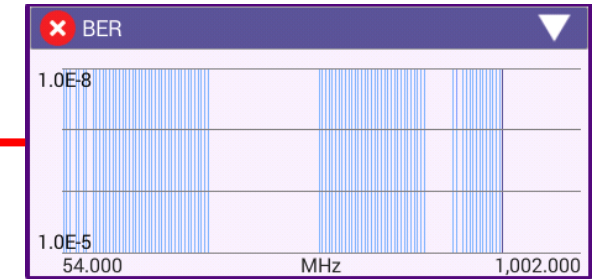

One Check - Upstream

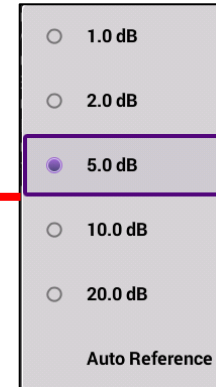
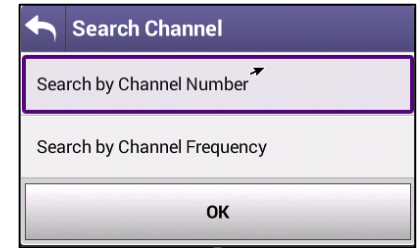
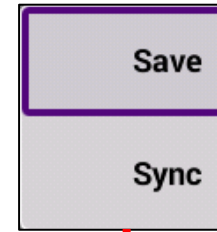
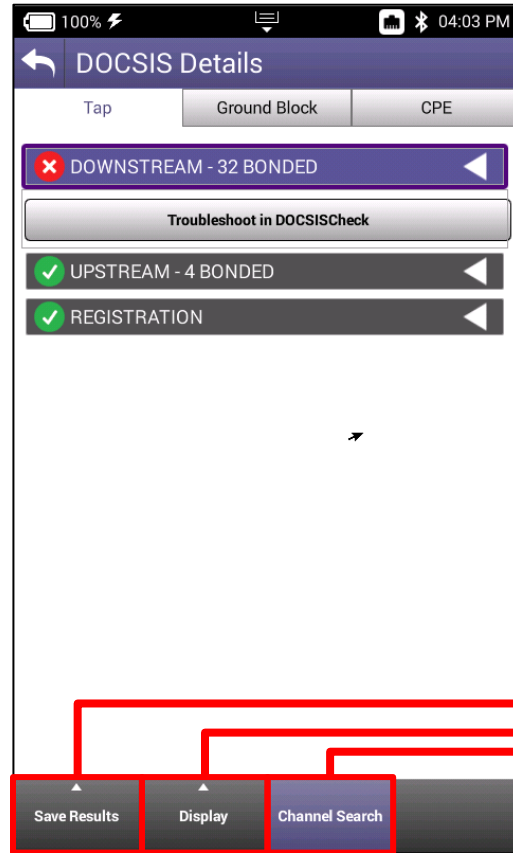
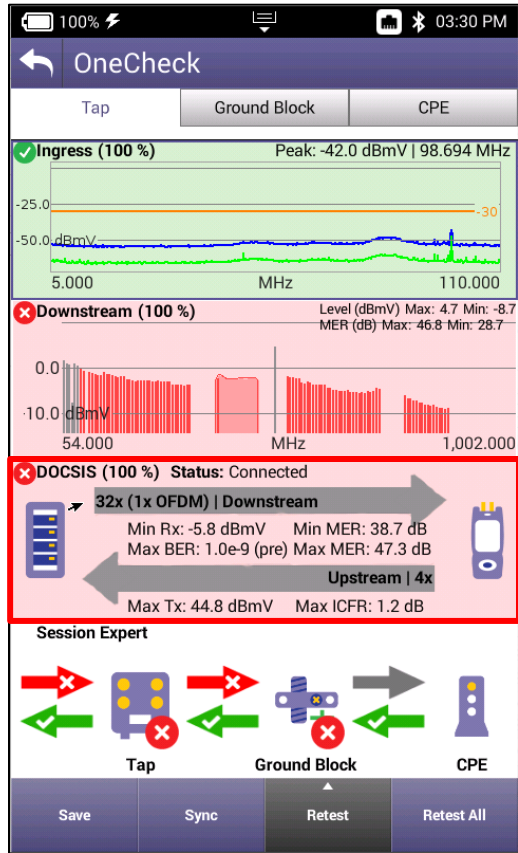

One Check - Upstream

100% 04:03 PM

DOCSIS Details

Tap Ground Block CPE

DOWNSTREAM - 32 BONDED

Troubleshoot in DOCSISCheck

UPSTREAM - 4 BONDED

REGISTRATION

THROUGHPUT

PACKET QUALITY

Save Results Display Channel Search

DOWNSTREAM - 32 BONDED

54.000 750.000 MHz

681.000 MHz

Annex B | 256 QAM | 5.361 Msym/s | 6.000 MHz

Level	MER	BER	BER
-5.7 dBmV	45.4 dB	1.0e-9 Pre	1.0e-9 Post
Echo	GD	ICFR	
-36.4 dBc	58 ns	0.6 dB	

Channel	Freq (MHz)	Level (dBmV)	MER (dB)
101	657.000	-5.5	44.3
102	663.000	-5.5	44.2
103	669.000	-5.6	44.3
104	675.000	-5.8	44.4
105	681.000	-5.7	45.4
106	687.000	-5.8	44.4
107	693.000	-5.3	44.1
108	699.000	-5.5	44.3
109	705.000	-5.2	44.1

UPSTREAM - 4 BONDED

17.800 MHz

64 QAM | 6.400 MHz | Unknown

TX Level	ICFR
40.5 dBmV	1.0 dB

UCD	Freq (MHz)	Level (dBmV)	ICFR (dB)
9	17.800	40.5	1.0
10	24.200	42.0	1.2
11	30.600	43.3	1.2
12	37.000	44.8	1.2

REGISTRATION

Service Plan: Charter Field Ops vKF - 00:07:11:14:1B:CF

Config File: ?
BEWGlyYABxEUG88KIsDi@CLLA4INpMjuhwlLUIE0BYV0zjkmFD_

Cable Modem

Provisioning Mode IPV4 ONLY

IPv4 Address 10.34.192.226

IPv4 Gateway Address 10.34.192.1

IPv4 Subnet Mask 255.255.224.0

IPv4 Config BEWGlyYABxEUG88KIsDi@CLLA4INpMjuhwlLUIE0BYV0zjkmFD_

CPE

IPv4 Address 76.175.15.154

IPv4 Subnet Mask 255.255.240.0

IPv4 Gateway Address 76.175.0.1

Servers

IPv4 TFTP Server 98.150.3.105

IPv4 DHCP Server 142.254.177.41

IPv4 TOD Server 98.150.3.105

One Check - Upstream

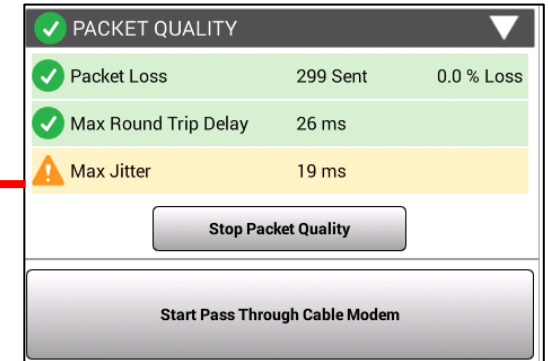
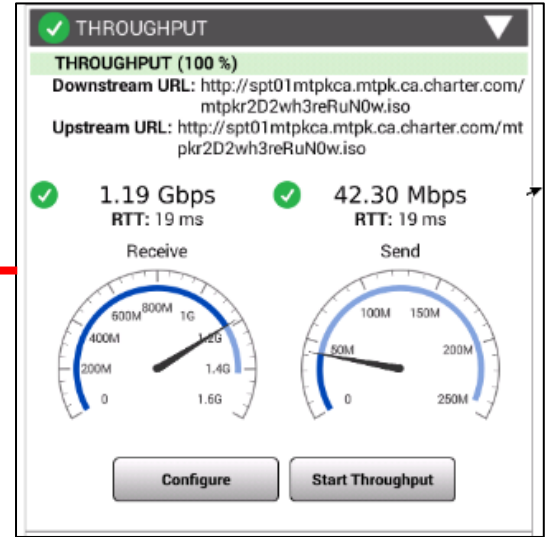
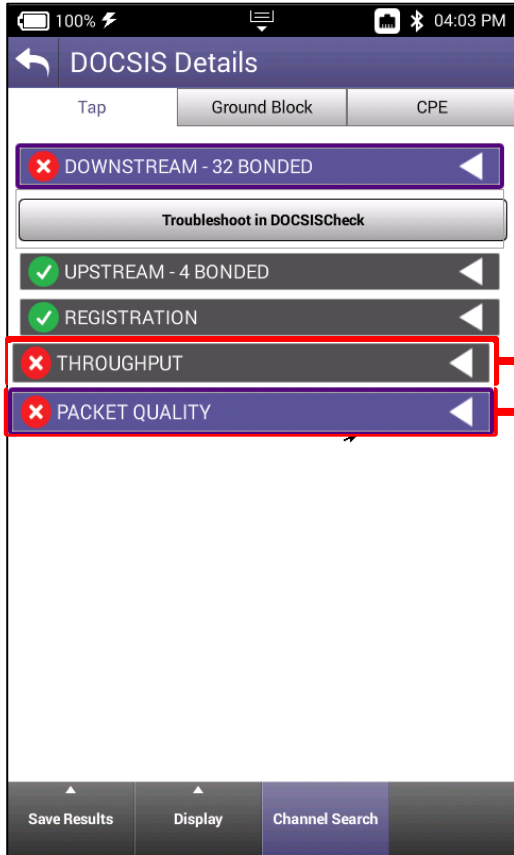

One Check – Session Expert

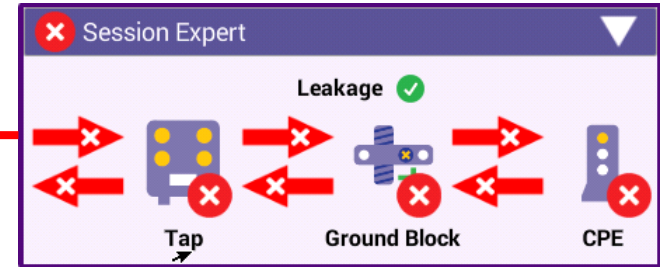
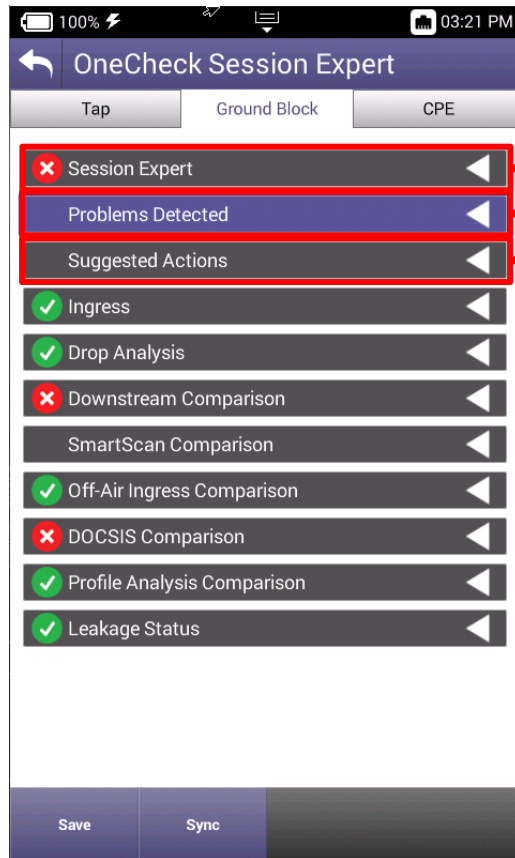
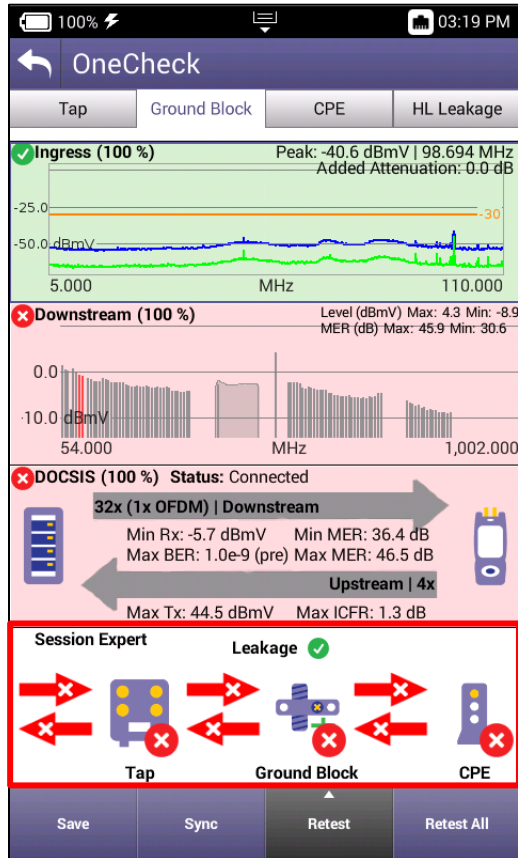

- Problems Detected**
- Signal quality
 - Downstream throughput problem
 - Packet jitter problem
 - Upstream throughput problem
 - Non-unique home detected

Suggested Actions

- ▼ Network downstream issue detected. Refer to maintenance

A network downstream issue has been detected. Retest at tap and refer to maintenance if problem persists.

One Check – Session Expert

100% 03:21 PM

OneCheck Session Expert

Tap Ground Block CPE

- Session Expert
- Problems Detected
- Suggested Actions
- Ingress**
- Drop Analysis**
- Downstream Comparison
- SmartScan Comparison
- Off-Air Ingress Comparison
- DOCSIS Comparison
- Profile Analysis Comparison
- Leakage Status

Save Sync

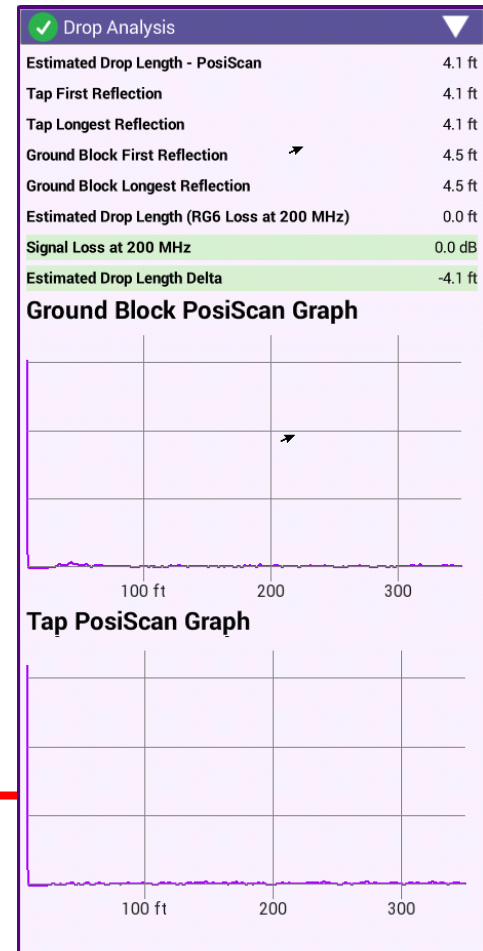
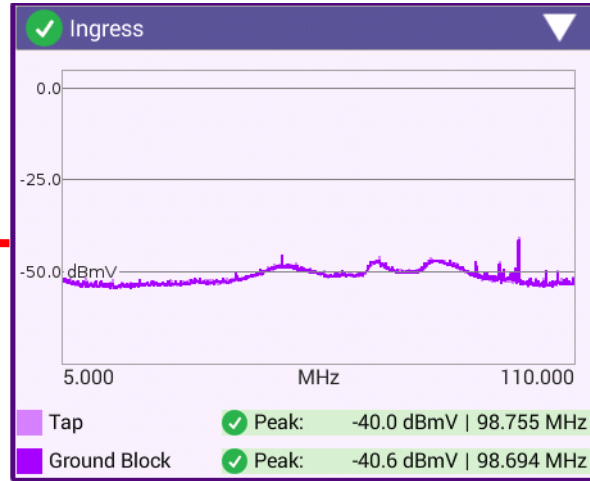

One Check – Session Expert

100% 03:21 PM

OneCheck Session Expert

Tap Ground Block CPE

- Session Expert
- Problems Detected
- Suggested Actions
- Ingress
- Drop Analysis
- Downstream Comparison**
- SmartScan Comparison
- Off-Air Ingress Comparison
- DOCSIS Comparison
- Profile Analysis Comparison
- Leakage Status

Save Sync

Downstream Comparison

	Tap	GB	CPE
Downstream			
Min Analog Level (dBmV)	4.3	4.3	4.3
Max Analog Level (dBmV)	4.3	4.3	4.3
Min Digital Level (dBmV)	-8.9	-8.9	-8.9
Max Digital Level (dBmV)	1.5	1.5	1.4
Min MER(dB)	31.0	30.6	30.0
Max MER (dB)	46.0	45.9	45.6
Max BER (Pre)	1.0e-8	1.0e-8	1.0e-8
Max BER (Post)	1.0e-8	1.0e-8	1.0e-8
Max Echo (dBc)	0.0	0.0	0.0
Max Group Delay (ns)	1.8	1.8	1.7
Max ICFR (dB)	4.5	4.5	4.5
Min Hum (%)	0.1	0.1	0.1
Max Hum (%)	0.3	0.4	0.4
OFDM			
Min Level (dBmV)	-3.1	-3.1	-3.0
Max Level (dBmV)	-1.8	-1.7	-1.8
Min MER PCTL (dB)	37.3	37.2	37.3
Max Stddev MER (dB)	0.6	0.6	0.6
Max ICFR (dB)	0.8	0.8	0.8
Max Echo (dBc)	-43.9	-42.9	-43.3

SmartScan Comparison

	Tap	GB	CPE
System Tilt (dB)	-5.8	-6.1	-5.9
Max Deviation (dB)	2.5	2.5	2.5

Off-Air Ingress Comparison

	Tap	GB	CPE
Default Ingress Span (dBmV)	-44.8	-46.4	-43.6

One Check – Session Expert

Profile Analysis Comparison

	Tap	GB	CPE
Profile A	Pass	Pass	Pass
Profile B	—	—	—
Profile C	—	—	—
Profile NCP	Pass	Pass	Pass
Profile PLC	Pass	Pass	Pass

Leakage Status

Duration	26 s	100%
----------	------	------

DOCSIS Comparison

	Tap	GB	CPE
Status	Connected	Connected	Connected
Downstream			
Number Bonded	32	32	32
Min Level (dBmV)	-5.7	-5.7	-5.7
Max Level (dBmV)	-2.0	-2.0	-2.0
Min MER (dB)	44.7	44.5	44.5
Max MER (dB)	46.9	46.5	46.5
OFDM			
Min Level (dBmV)	-3.1	-3.0	-3.0
Max Level (dBmV)	-1.8	-1.8	-1.8
Min MER PCTL (dB)	37.2	37.3	37.1
Max Stddev MER (dB)	0.6	0.6	0.6
Max ICFR (dB)	0.9	0.8	0.8
Max Echo (dBc)	-43.2	-43.2	-43.2
Upstream			
Number Bonded	4	4	4
Max Tx Level (dBmV)	44.0	44.5	44.0
Max ICFR (dB)	1.3	1.3	1.3
Services			
DS Throughput (Mbps)	0.0	0.0	0.0
US Throughput (Mbps)	0.0	0.0	0.0
Packet Loss (%)	0.0%	0.0%	0.0%
Max Round Trip Delay (ms)	18	17	17
Max Jitter (ms)	10	10	10

CATV Network Configurations

CATV Network

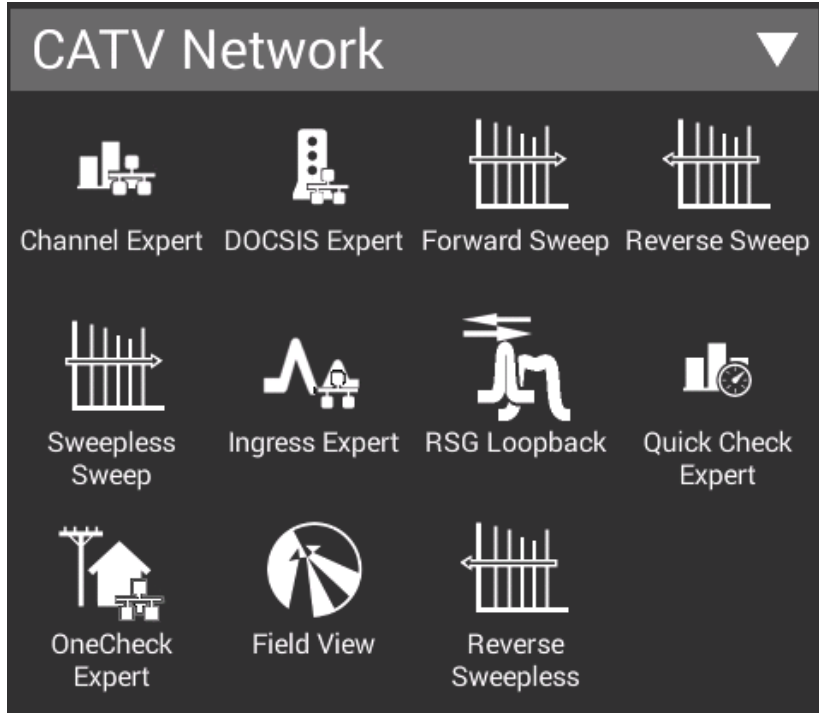

- CATV NETWORK offers 8 test functions
 - Channel Expert
 - DOCSIS Expert
 - Forward Sweep (Active)
 - Reverse Sweep (Active)
 - Sweepless Sweep (Downstream)
 - Ingress Expert
 - Return Signal Generator w/ Loopback
 - Quick Check Expert
 - OneCheck Expert
 - Field View (with Return Signal Generator)
 - Reverse Sweepless (Upstream)

Quick Check Expert

Quick Check Expert

QuickCheck Expert can be run in two modes

- Quick Check
- Full Scan

To populate the FULL SCAN, user must first save a channel plan in ChannelCheck before loading it in QuickCheck Expert

To populate the QuickCheck mode with channels, user must add them manually

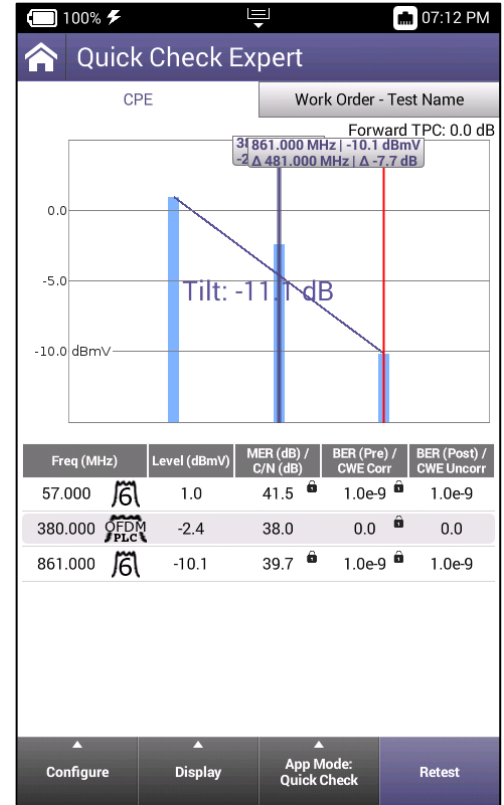
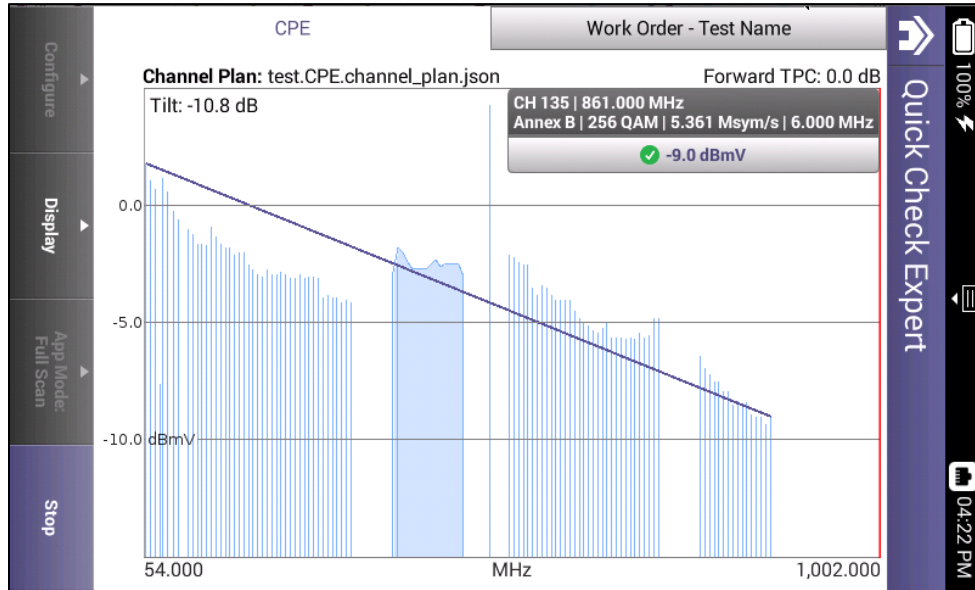

Quick Check Expert – Saving Channel Plans

To save a Channel Plan, run the CHANNELCHECK test under CATV

After test completes, use the BACK button to return to CHANNELCHECK SETUP

Select SAVE CHANNEL PLAN. A message will display indicating the Channel Plan has been saved. The Channel plan will be named after the WORK ORDER ID

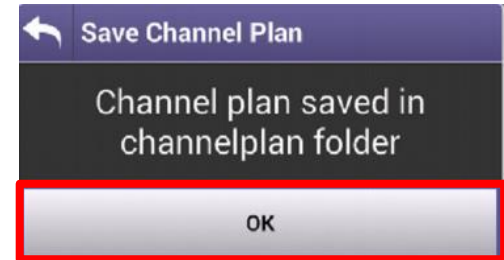
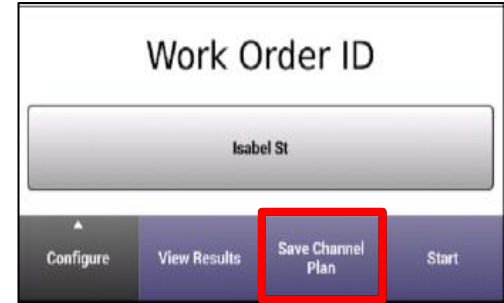
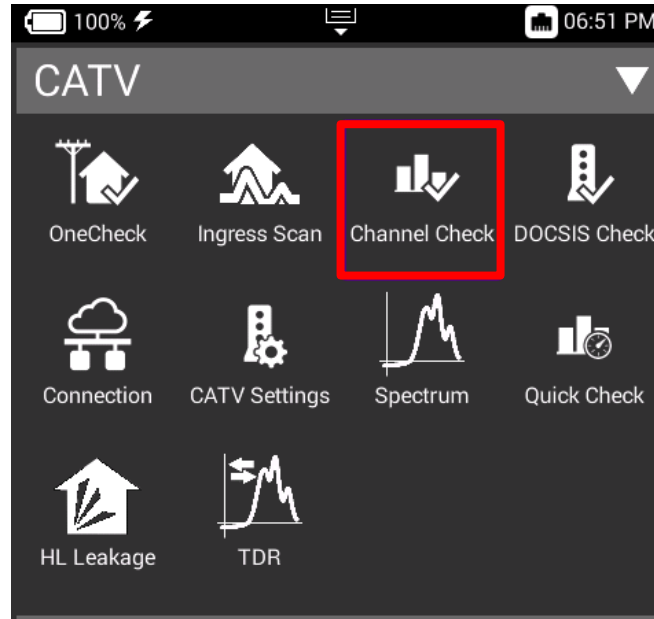

Quick Check Expert – Loading Channel Plans

Return to QUICKCHECK
EXPERT under CATV
NETWORK

Test will automatically run,
STOP test and change APP
MODE to FULL SCAN

Select CONFIGURE and select
CHANNEL PLAN

Select the appropriate saved
CHANNEL PLAN

The image shows a mobile application interface for CATV Network. The top status bar shows 100% battery and 06:55 PM. The app title is 'CATV'. Below the title is a dropdown menu for 'CATV Network'. The main screen displays a grid of test options: Channel Expert, DOCSIS Expert, Forward Sweep, Reverse Sweep, Sweepless Sweep, Ingress Expert, RSG Loopback, Quick Check Expert (highlighted with a red box), OneCheck Expert, Field View, and Reverse Sweepless. A red line connects the 'Quick Check Expert' icon to a configuration screen on the right. This screen has a top navigation bar with 'Configure', 'Display', 'App Mode: Full Scan', and 'Start' buttons. The 'Configure' button is highlighted with a red box. The configuration screen lists several settings: 'Select Test Point Template' (CPE), 'Channel Plan' (test.CPE.channel_plan.json, highlighted with a red box), 'Set Diplexer' (42 - 1000 MHz), 'Select Limit Plan' (CPE), 'Save Test' (Save current test to a Work Order), 'View Tests' (View previous tests), and 'View StrataSync Configuration'. Below the main screen, a 'Select Channel Plan' dialog is shown with a red box around it, containing a radio button and the text 'test.CPE.channel_plan.json'.

Quick Check Expert – Full Scan Mode

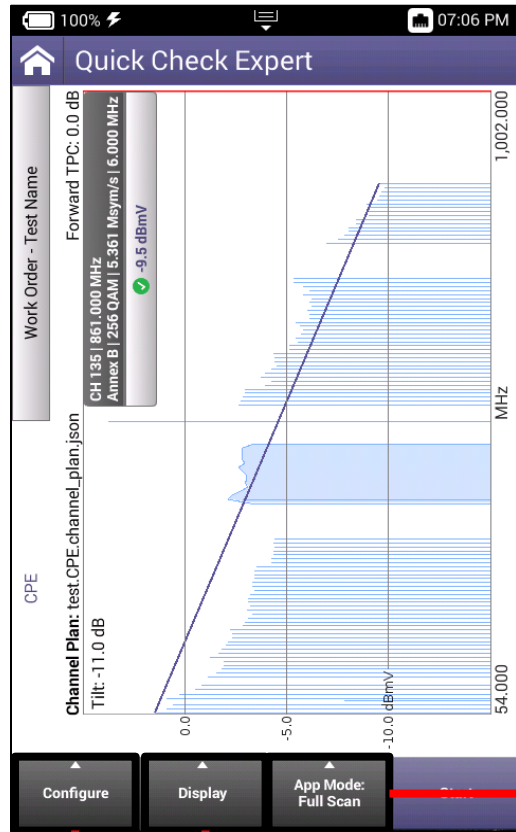

Quick Check

Full Scan

Full Screen

Marker

dB/div

5.0 dB

Reference Now

Select Test Point Template

CPE

Channel Plan ↗

test.CPE.channel_plan.json

Set Diplexer

42 - 1000 MHz

Select Limit Plan

CPE

Save Test

Save current test to a Work Order

View Tests

View previous tests

View StrataSync Configuration >

Quick Check Expert – Quick Check Mode

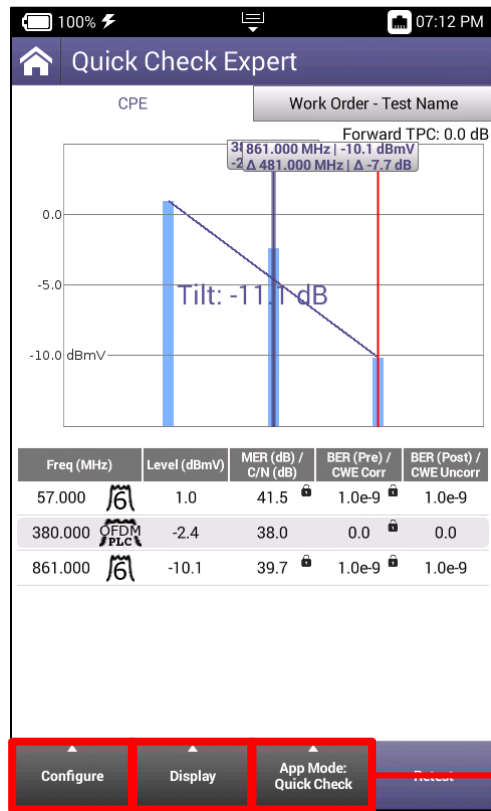

Quick Check
 Full Scan

1.0 dB
 2.0 dB
 5.0 dB
 10.0 dB
 20.0 dB

Reference Now

Auto Reference
 Δ Marker

Select Test Point Template
CPE

Carrier Configuration >

Channel Plan
test.CPE.channel_plan.json

Set Diplexer
42 - 1000 MHz

MER
 BER / OFDM CWE
 Carrier To Noise

Save Test
Save current test to a Work Order

View Tests
View previous tests

View StrataSync Configuration >

Channel Expert

Channel Expert Measurements

- Channel Scan no need for Channel plan
- Measures Video, QAM, OFDM
- Typical QAM Measurements include Level, MER, Pre and Post BER
- Measures Echo, GD, ICFR (This is an Adaptive Equalizer Test)
- Hum (Less than 1000 kHz)
- DQI (Digital Quality Index)
- Ingress Under Carrier
- ADJ Channel Delta

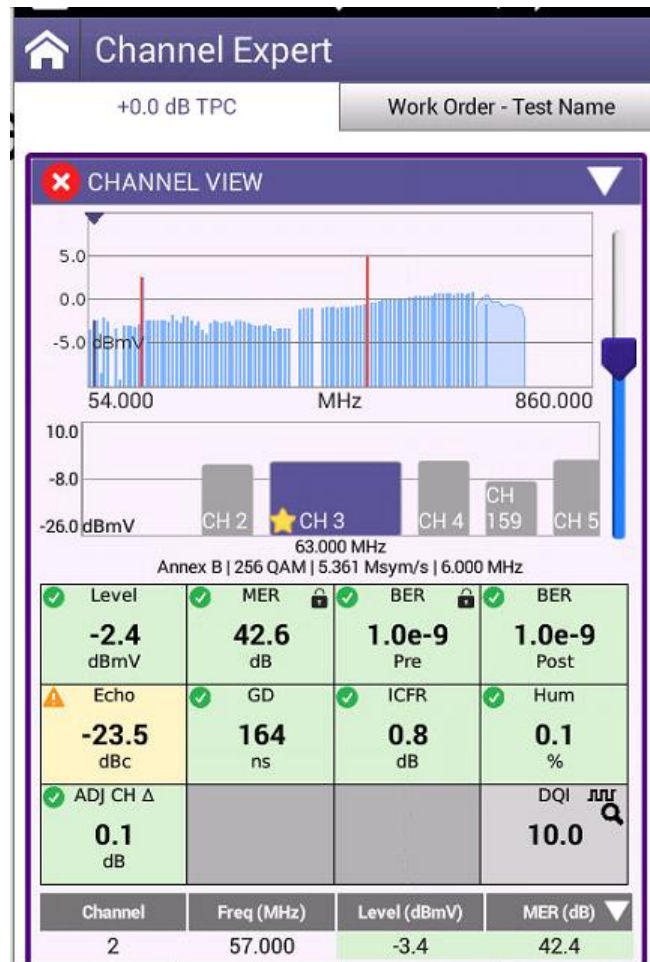

Channel Expert

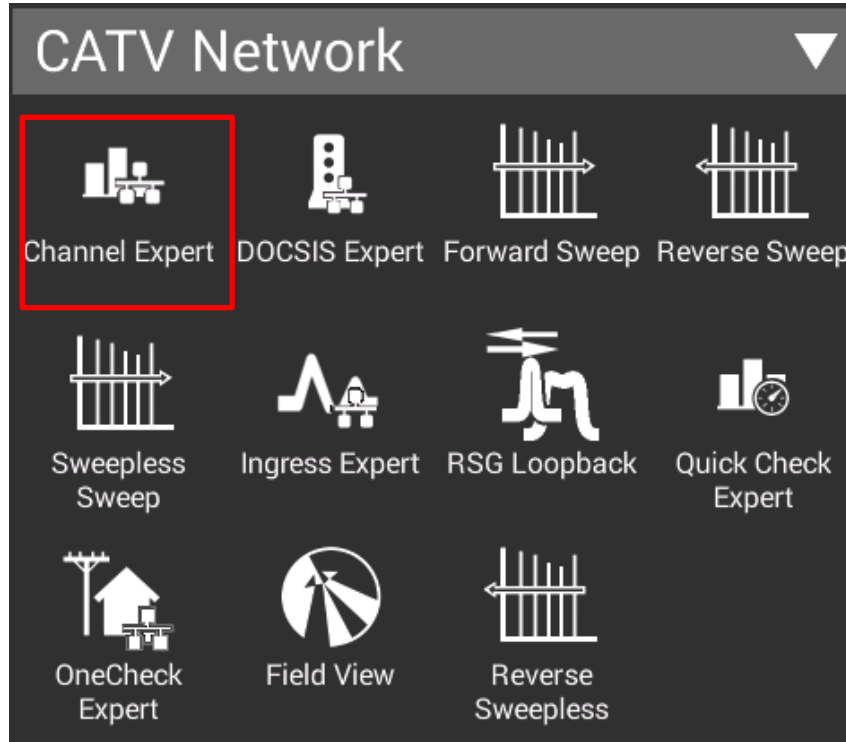
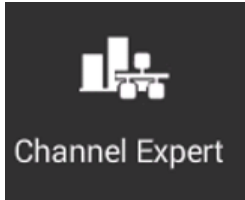

Channel Expert Configure

- All EXPERT test functions will feature a CONFIGURE button when the STOP function is pressed
- All new test functions are LIVE tests so to access CONFIGURE, test must be stopped first

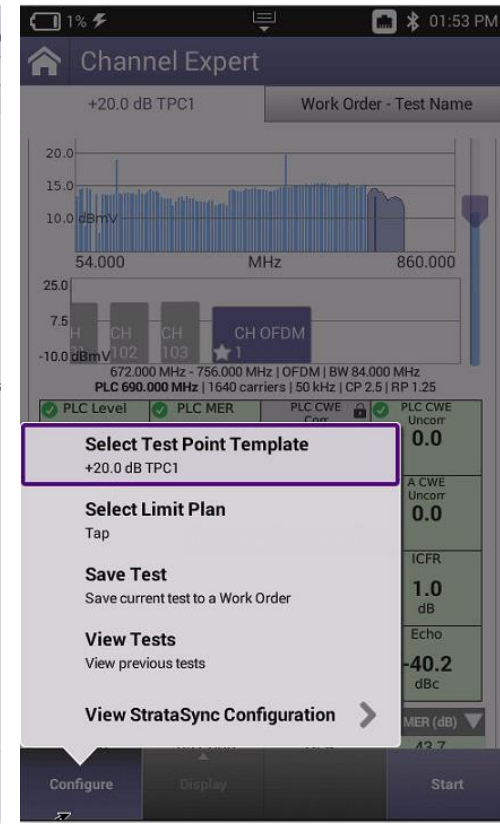
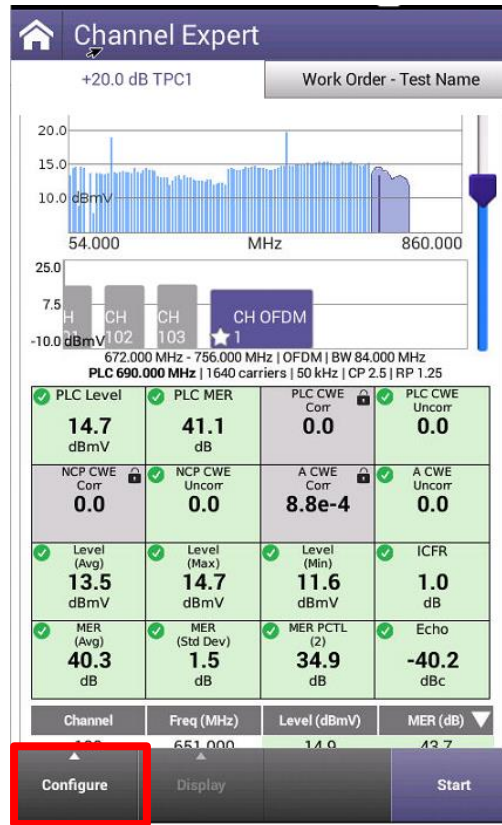
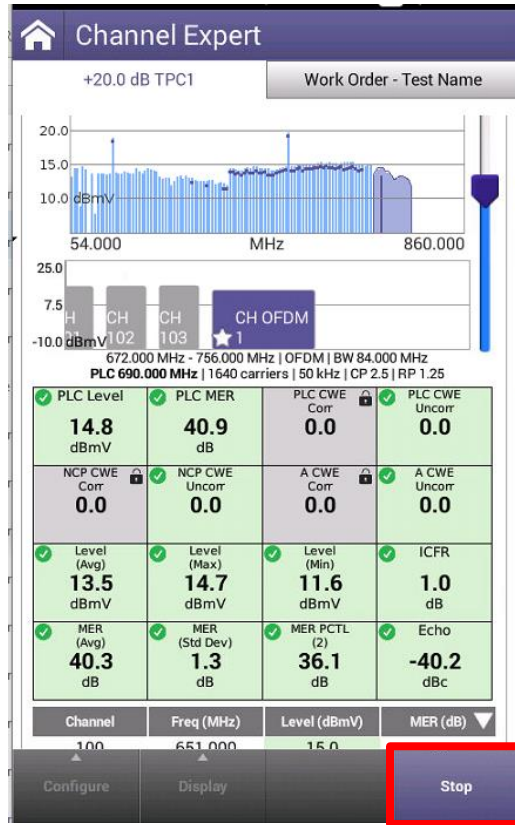

Channel Expert Configure Test point

31% 03:03 PM

Channel Expert

+0.0 dB TPC Work Order - Test Name

CHANNEL VIEW

5.0
0.0
-5.0
-10.0
-26.0 dBmV

54.000 MHz 860.000

63.000 MHz

Annex B | 256 QAM | 5.361 Msym/s | 6.000 MHz

Level	MER	BER	BER
-2.5 dBmV	42.6 dB	1.0e-9 Pre	1.0e-9 Post
Echo	GD	ICFR	Hum
-23.5 dBc	168 ns	0.8 dB	0.2 %
ADJ CH Δ			DQI
0.1 dB			10.0

Channel Freq (MHz) Level (dBmV) MER (dB)

2 57.000 -3.5 42.3

Configure Display Channel Search Start

Select Test Point Template

+0.0 dB TPC

Select Limit Plan

Tap

Save Test

Save current test to a Work Order

View Tests

View previous tests

View StrataSync Configuration

Select Test Point Template

+0.0 dB TPC

+20.0 dB TPC

View Delete Copy Done

New Custom Template

+20 dB TPC1 1 - 40 chars

Save

Select Test Point Template

+0.0 dB TPC

+20 dB TPC1

Channel Expert Configure

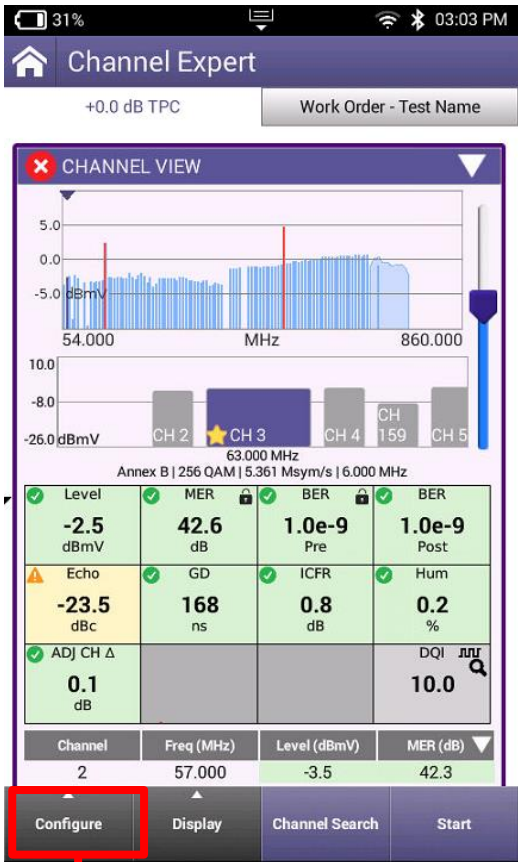

Select Test Point Template
+0.0 dB TPC

Select Limit Plan
Tap

Save Test
Save current test to a Work Order

View Tests
View previous tests

View StrataSync Configuration

Select Limit Plan

- Tap
- Ground Block
- CPE

View Test Results

Tests for Current Work Order:

H12345

StrataSync Configuration

Test Point Templates File Name
default-testpoint-templates

Limit Plan File Name
Thome1

Limit Plan Exclusion Zone File Name
default-exclusionzones

Channel Expert Configure Save Test

CHANNEL VIEW

54.000 MHz 860.000

26.0 dBmV

CH 2 CH 3 CH 4 CH 159 CH 5

Level	MER	BER	BER
-2.5 dBmV	42.6 dB	1.0e-9 Pre	1.0e-9 Post
-23.5 dBc	168 ns	0.8 dB	0.2 %
ADJ CH Δ 0.1 dB			10.0

Channel Freq (MHz) Level (dBmV) MER (dB)

2 57.000 -3.5 42.3

Configure Display Channel Search Start

Channel Expert

+20.0 dB TPC1 Work Order - Test Name

20.0 dBmV

54.000 MHz 860.000

CH 02 CH 103 CH OFDM

672.000 MHz - 756.000 MHz | OFDM | BW 84.000 MHz
PLC 690.000 MHz | 1640 carriers | 50 kHz | CP 2.5 | RP 1.25

PLC Level! PLC MER! PLC CWE! PLC CWE Uncorr 0.0

Select Test Point Template
+20.0 dB TPC1

Select Limit Plan
Tap

Save Test
Save current test to a Work Order

View Tests
View previous tests

View StrataSync Configuration

Configure Display Start

Save Test

Save Test to Work Order

Test Name Isabel 20191

Work Order ID Guide1

Set Name to Current Date **Save**

Test Name

Isabel 20191 1 - 50 chars

OK

Select Work Order

New Work Order ...

- Guide1**
- T3
- T2
- T1
- test2
- Chaplin
- Charlie
- Isabel

Configure – View Test – Delta Tab

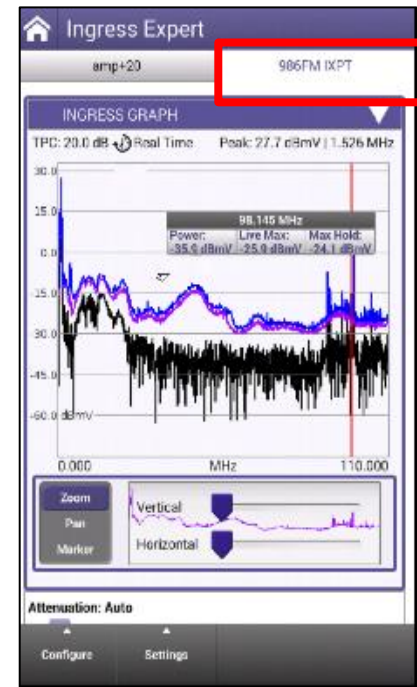
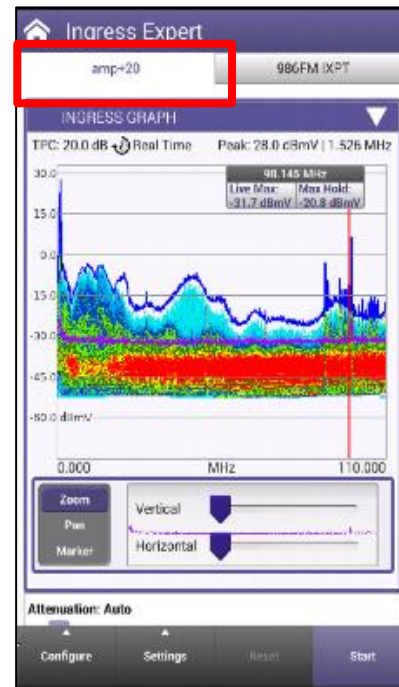
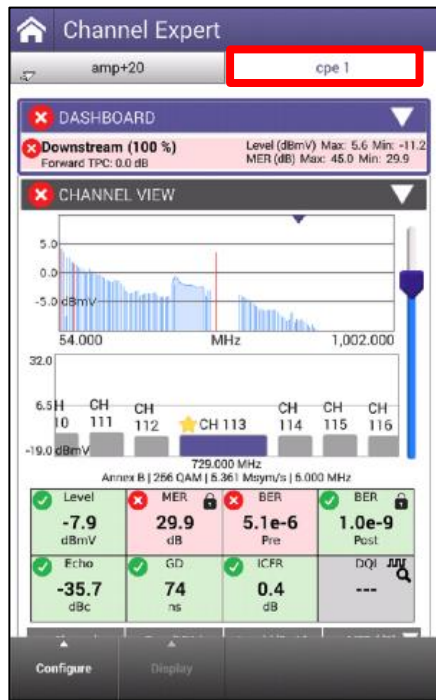
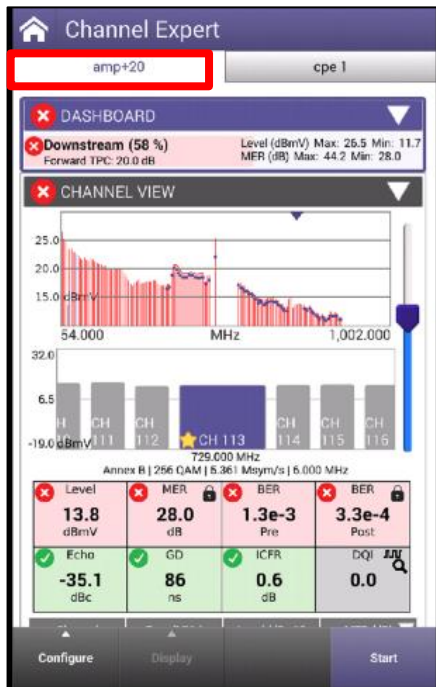

Channel Expert Configure

31% 03:03 PM

Channel Expert

+0.0 dB TPC Work Order - Test Name

CHANNEL VIEW

54.000 MHz 860.000

26.0 dBmV

63.000 MHz

Annex B | 256 QAM | 5.361 Msym/s | 6.000 MHz

Level	MER	BER	BER
-2.5 dBmV	42.6 dB	1.0e-9 Pre	1.0e-9 Post
-23.5 dBc	168 ns	0.8 dB	0.2 %
ADJ CH Δ			DQI 10.0

Channel	Freq (MHz)	Level (dBmV)	MER (dB)
2	57.000	-3.5	42.3

Configure Display Channel Search Start

Select Test Point Template

+0.0 dB TPC

Select Limit Plan

Tap

Save Test

Save current test to a Work Order

View Tests

View previous tests

View StrataSync Configuration

1.0 dB

2.0 dB

5.0 dB

10.0 dB

20.0 dB

Auto Reference

Select Limit Plan

Tap

Ground Block

CPE

Save Test

Save Test to Work Order

Test Name

Work Order ID

Work Order - 16-49-00 08-05-2020

View Test Results

Tests for Current Work Order:

H12345

StrataSync Configuration

Test Point Templates File Name

default-testpoint-templates

Limit Plan File Name

Thome1

Limit Plan Exclusion Zone File Name

default-exclusionzones

Channel Expert Configure

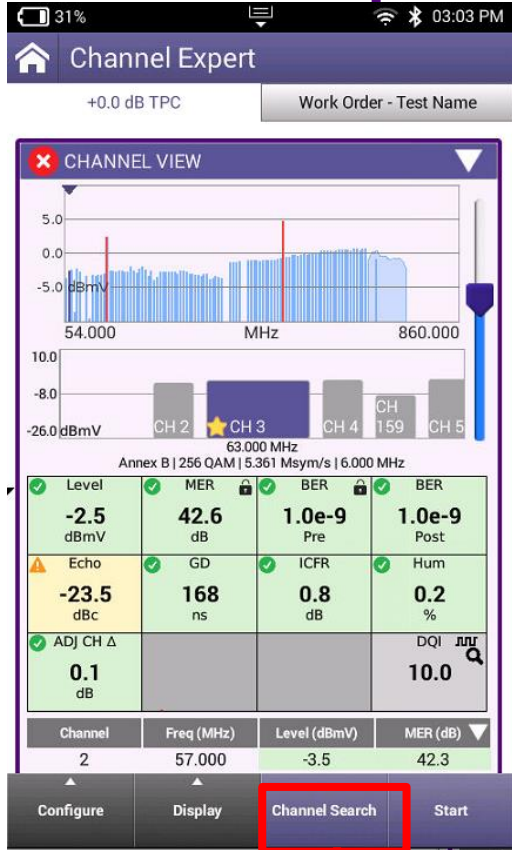

Search Channel

Search by Channel Number

Search by Channel Frequency

OK

Enter Channel Number

2

Find Channel

Enter Channel Frequency

57

Find Channel

Channel Expert QAM

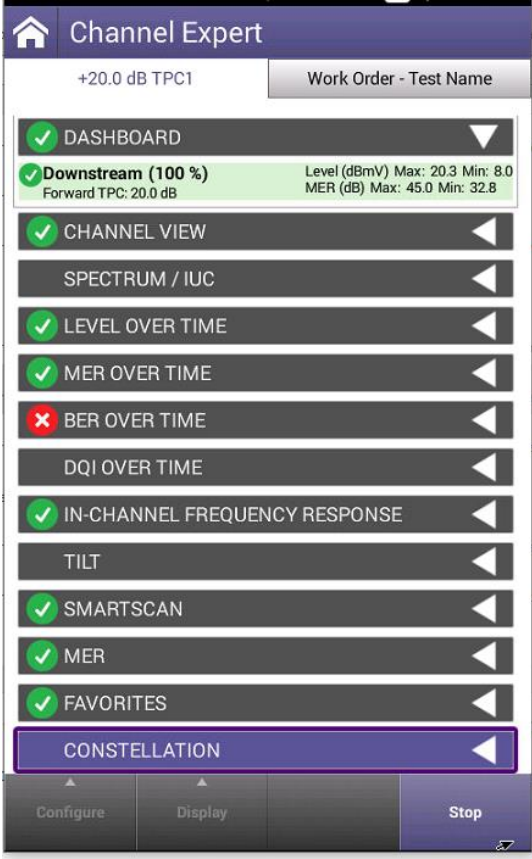

Test Point Compensation

+0.0 dB TPC

Select Channel

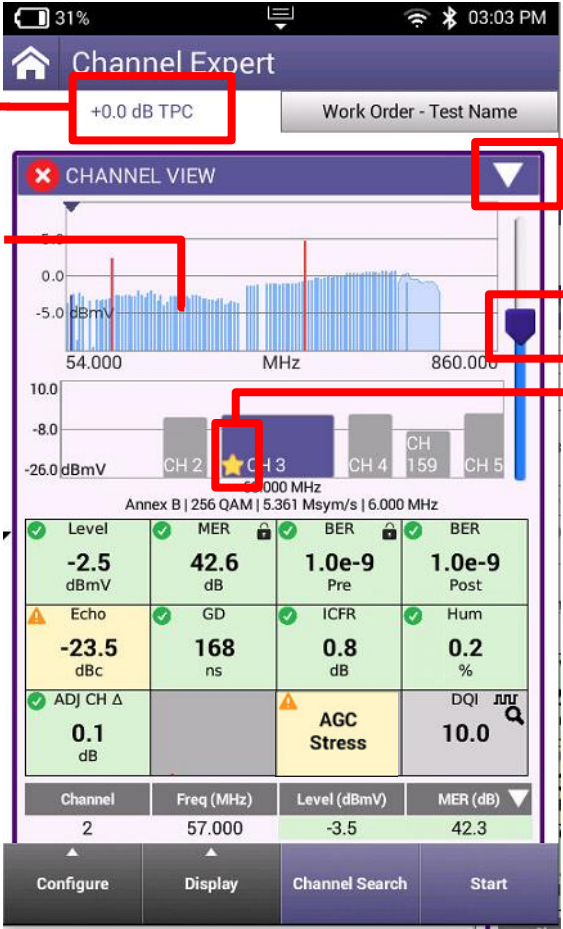

Open/close window

Reference

Press star to turn to gold color for marking as favorite channel

Slide left or right to change channel

Channel Expert QAM

Channel	Freq (MHz)	Level (dBmV)	MER (dB)
2	57.000	-3.5	42.3

Selected Channel

Level
-2.5
dBmV

Channel RF power Level

MER
42.6
dB

Modulation Error Ratio

Like Carrier to Noise Ratio
Composite Second Order and
Composite Third Order

BER
1.0e-9
Pre

Bit error rate that are
detected

BER
1.0e-9
Post

Bit error rated that pass
through

Adaptive Equalizer Measurements

Echo
-23.5
dBc

Highest tap stress level of
reflection

GD
168
ns

Highest delay of a group
of signals

ICFR
0.8
dB

In Channel Peak to Valley
measurement of a QAM
carrier

Colors represent the Limit set value

Pass

Warning

Fail

No
limit

Channel Expert QAM

Level	MER	BER	BER
-2.5 dBmV	42.6 dB	1.0e-9 Pre	1.0e-9 Post
Echo	GD	ICFR	Hum
-23.5 dBc	168 ns	0.8 dB	0.2 %
ADJ CH Δ		AGC Stress	DQI
0.1 dB			10.0

Selected Channel

Hum
0.2
%

Hum is a signal impairment which causes the amplitude of a modulated carrier to vary

ADJ CH Δ
0.1
dB

Adjacent Channel video is the delta of the RF carrier that is next to it.

DQI
10.0

Digital Quality Index is the value assigned to show how good the RF signal is performing

AGC Stress

Automatic Gain Control level of the channel is not consistent and is varying in amplitude in milliseconds

Colors represent the Limit set value

Pass Warning Fail No limit

Channel Expert QAM

Channel Expert

+20.0 dB TPC1 Work Order - Test Name

- ✓ DASHBOARD
- ✓ Downstream (100 %) Level (dBmV) Max: 20.3 Min: 8.0
Forward TPC: 20.0 dB MER (dB) Max: 45.0 Min: 32.8
- ✓ CHANNEL VIEW
- SPECTRUM / IUC
- ✓ LEVEL OVER TIME
- ✓ MER OVER TIME
- ✗ BER OVER TIME
- DQI OVER TIME
- ✓ IN-CHANNEL FREQUENCY RESPONSE
- TILT
- ✓ SMARTSCAN
- ✓ MER
- ✓ FAVORITES
- CONSTITUTION

Configure Display Stop

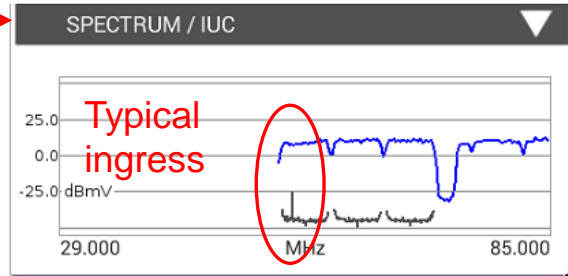

Spectrum/ICU
9 Channel Spectrum view of
Ingress under the carrier

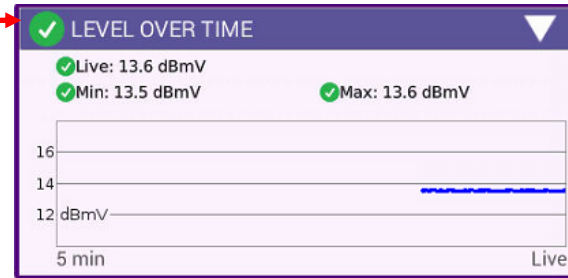

Measures the Level of
selected channel in a 5-minute
window

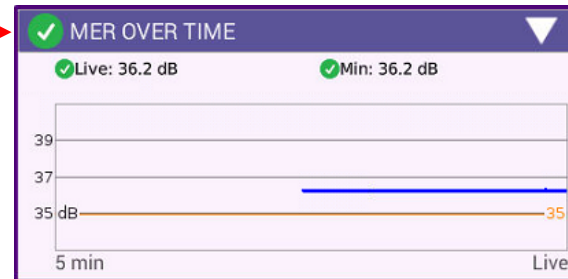

Measures the MER of
selected channel in a 5-
minute window

Channel Expert QAM

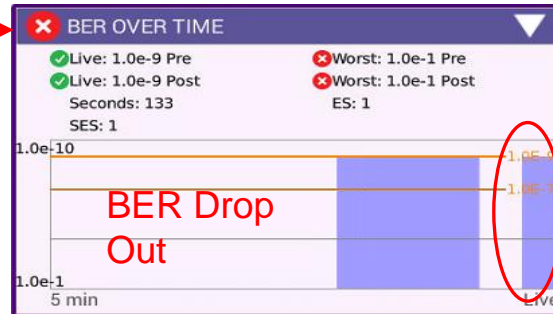
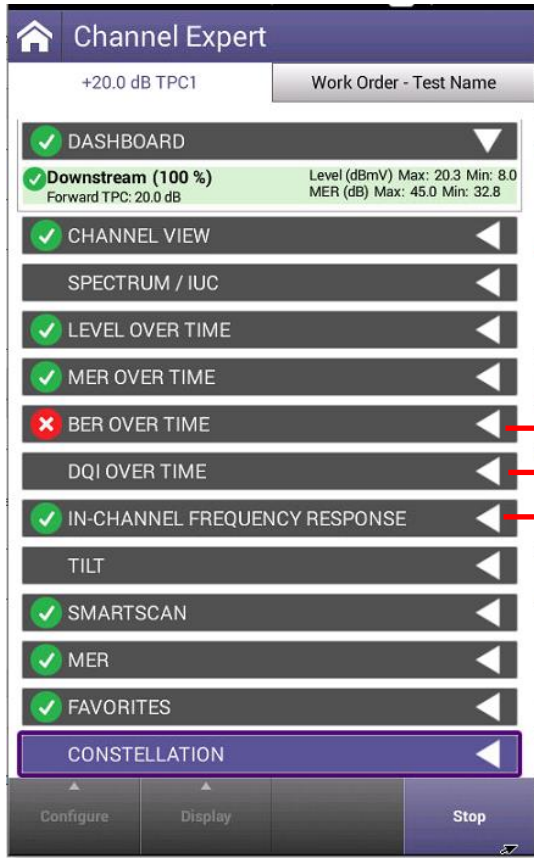

Measures the BER of selected channel in a 5-minute window

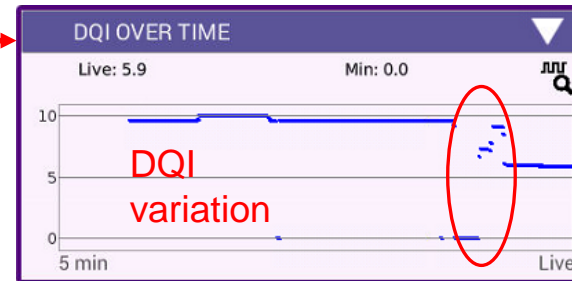

Measures the DQI of selected channel in a 5-minute window

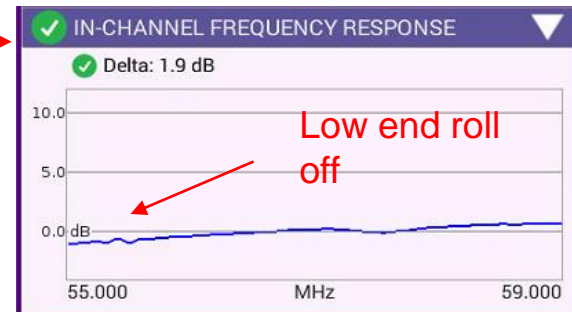

Measures the In-channel frequency response level of a QAM carrier

Channel Expert QAM

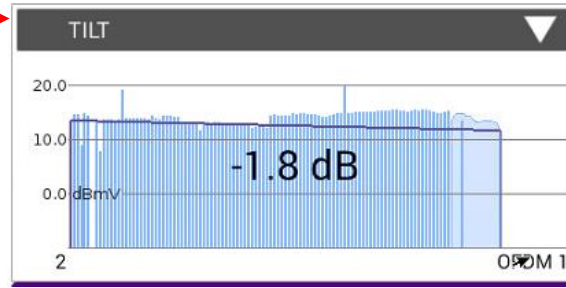
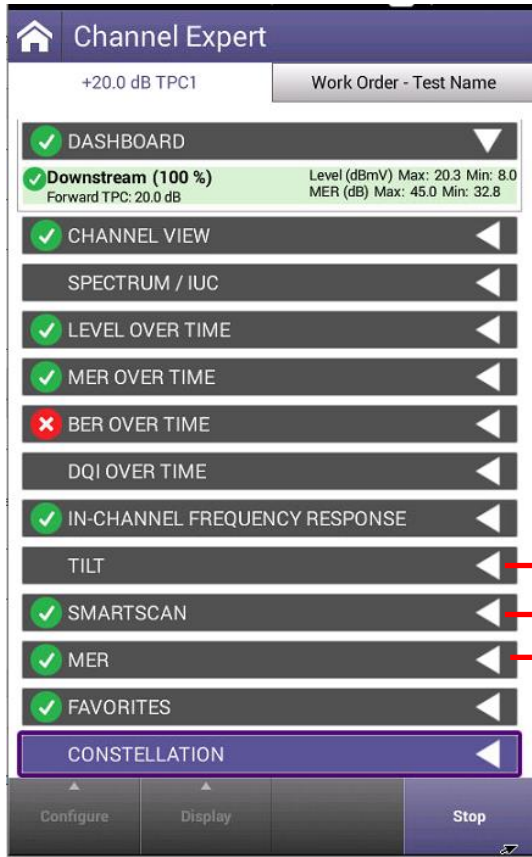

Tilt Measures the Difference in RF level or Delta between the lowest and highest channels

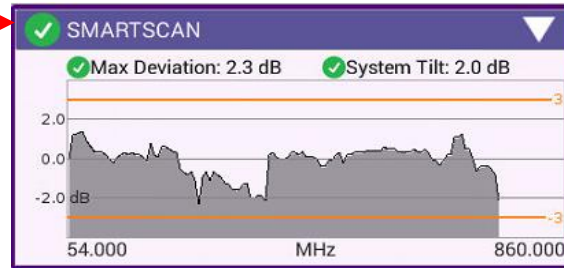

Smart scan removes the over all tilt to show typical deviation in a graph

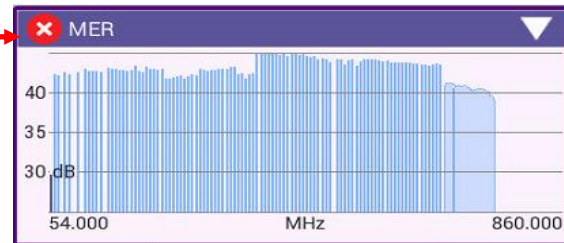

MER shows the value of all the QAM channels in the system in a bar graph

Channel Expert QAM

Channel Expert

+20.0 dB TPC1 Work Order - Test Name

- ✓ DASHBOARD
- ✓ Downstream (100 %) Level (dBmV) Max: 20.3 Min: 8.0
Forward TPC: 20.0 dB MER (dB) Max: 45.0 Min: 32.8
- ✓ CHANNEL VIEW
- SPECTRUM / IUC
- ✓ LEVEL OVER TIME
- ✓ MER OVER TIME
- ✗ BER OVER TIME
- DQI OVER TIME
- ✓ IN-CHANNEL FREQUENCY RESPONSE
- TILT
- ✓ SMARTSCAN
- ✓ MER
- ✓ FAVORITES
- CONSTELLATION**

Configure Display Stop



Up to 15 favorite channel can be selected by pressing the white star in the channel view and turning it gold

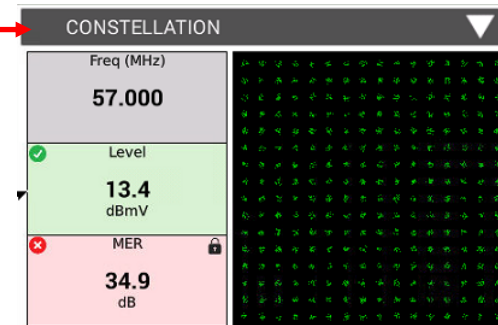

See the Constellation of the selected channel

Channel Expert OFDM

Channel Expert

+20.0 dB TPC1 Work Order - Test Name

- DASHBOARD
- Downstream (100 %) Level (dBmV) Max: 15.3 Min: -3.7
Forward TPC: 20.0 dB MER (dB) Max: 45.7 Min: 26.5
- CHANNEL VIEW
- SPECTRUM / IUC
- LEVEL VARIATION (OFDM)
- MER VARIATION (OFDM)
- PROFILE ANALYSIS
- IN-CHANNEL FREQUENCY RESPONSE
- TILT
- SMARTSCAN
- MER
- FAVORITES

Configure Display Channel Search Stop

NCP Next Codeword Pointer
Tells the modem which codeword and present and in which profile

Level measurements of all the carriers based on 6 MHz

Average MER of all the QAM carriers.

MER Std Deviation
MER a 2%

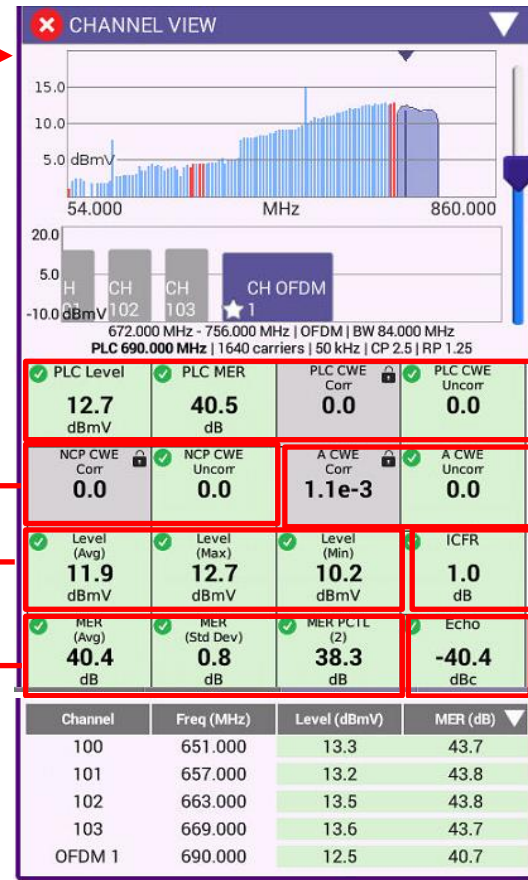

PLC PHY Link Channel
Contains critical OFDM signal information

Codeword errors of profile A

ICFR- In Channel Frequency Response

Adaptive equalizer worst case stress tap

Level and MER of 4 adjacent SC-QAM and OFDM

Channel Expert OFDM

Channel Expert

+20.0 dB TPC1 Work Order - Test Name

- DASHBOARD
- Downstream (100 %) Level (dBmV) Max: 15.3 Min: -3.7
Forward TPC: 20.0 dB MER (dB) Max: 45.7 Min: 26.5
- CHANNEL VIEW**
- SPECTRUM / IUC
- LEVEL VARIATION (OFDM)
- MER VARIATION (OFDM)
- PROFILE ANALYSIS
- IN-CHANNEL FREQUENCY RESPONSE
- TILT
- SMARTSCAN
- MER
- FAVORITES

Configure Display Channel Search Stop

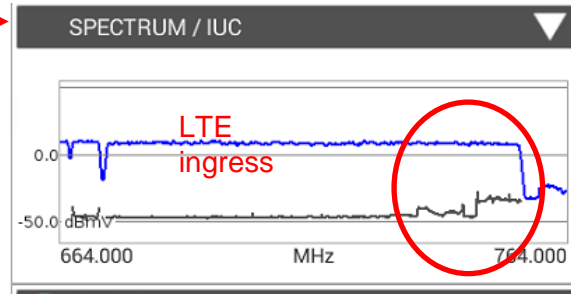

IUC Ingress under carrier

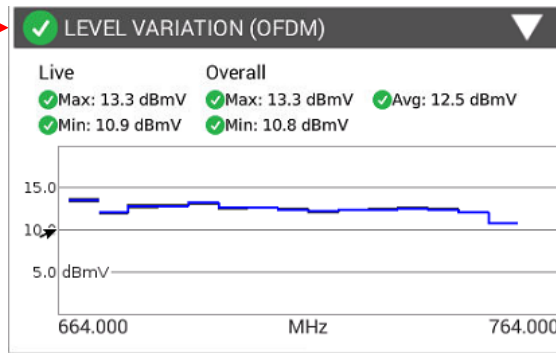

Level of OFDM carries measures at 6 MHz spacing

Channel Expert OFDM

Channel Expert
+20.0 dB TPC1 Work Order - Test Name

- DASHBOARD
- Downstream (100 %) Level (dBmV) Max: 15.3 Min: -3.7
Forward TPC: 20.0 dB MER (dB) Max: 45.7 Min: 26.5
- CHANNEL VIEW
- SPECTRUM / IUC
- LEVEL VARIATION (OFDM)
- MER VARIATION (OFDM)
- PROFILE ANALYSIS
- IN-CHANNEL FREQUENCY RESPONSE
- TILT
- SMARTSCAN
- MER
- FAVORITES

Configure Display Channel Search Stop

MER graph of OFDM

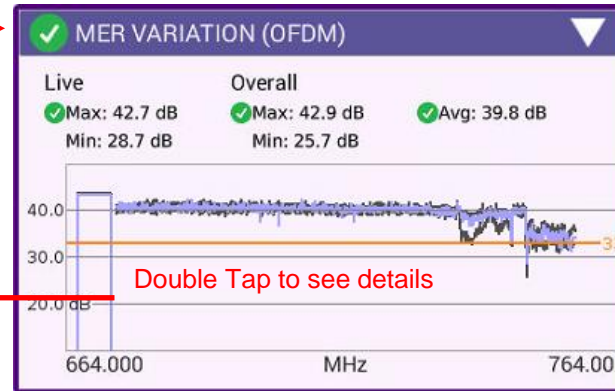

Can use marker to see exact frequencies of carriers and MER values

Channel Expert OFDM

Channel Expert

+20.0 dB TPC1 Work Order - Test Name

Downstream (100 %) Level (dBmV) Max: 15.3 Min: -3.7
Forward TPC: 20.0 dB MER (dB) Max: 45.7 Min: 26.5

CHANNEL VIEW

SPECTRUM / IUC

LEVEL VARIATION (OFDM)

MER VARIATION (OFDM)

PROFILE ANALYSIS

IN-CHANNEL FREQUENCY RESPONSE

TILT

SMARTSCAN

MER

FAVORITES

Configure Display Channel Search Stop

PROFILE	LOCKED	CWE (Corr)	CWE (Uncorr)	Max Mod
PLC	YES	0.0	0.0	16QAM
NCP	YES	0.0	0.0	16QAM
A	YES	3.9e-1	0.0	256QAM
B	YES	1.7e-1	0.0	1024QAM
C	YES	9.8e-1	0.0	2048QAM
D	YES	9.9e-1	3.4e-5	2048QAM

Profile View of Cable modem.

Helps determine how well the network is performing at this location

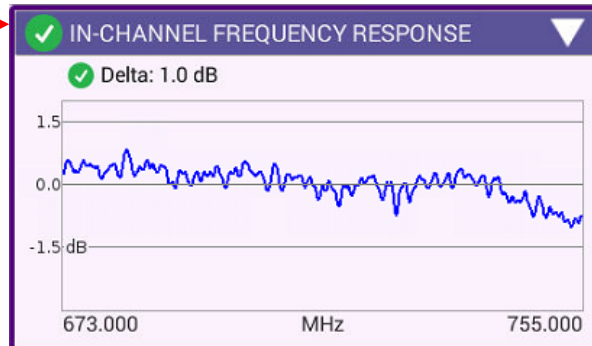

In channel Frequency Response across a OFDM band can help determine if a refecton or roll off is occurring

DOCSIS Expert

DOCSIS Check

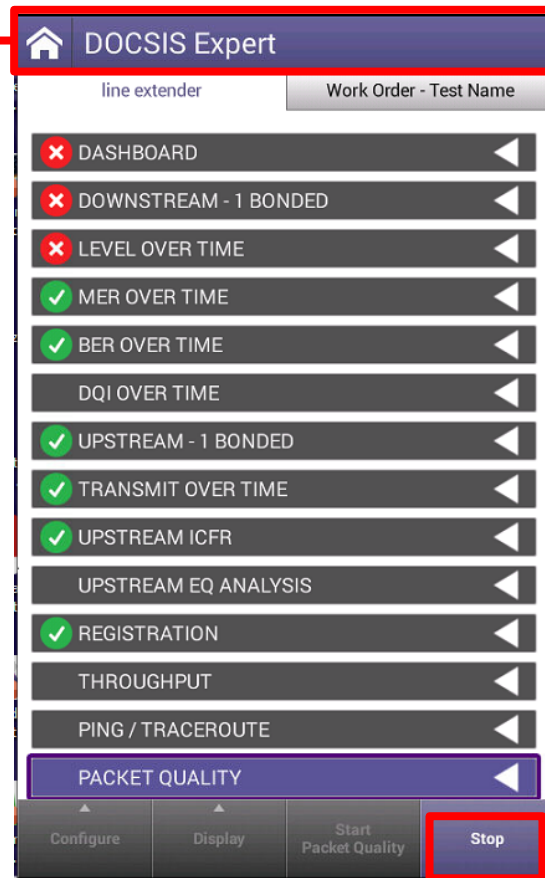
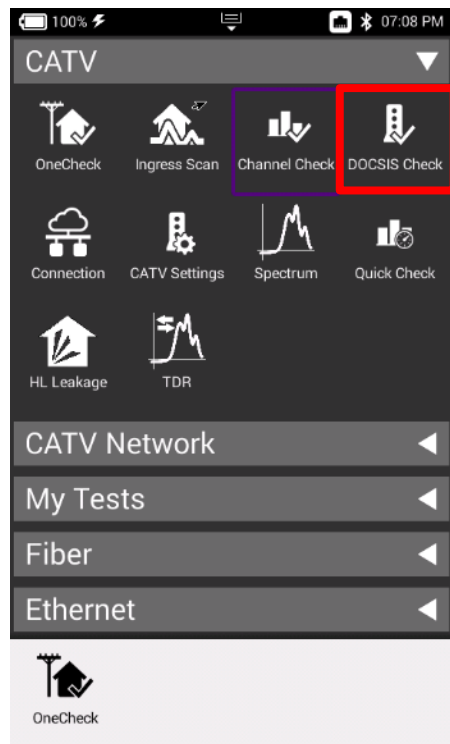

DOCSIS Check

DOCSIS Expert

+0.0 dB TPC Work Order - Test Name

- ✓ DOWNSTREAM - 32 BONDED
- ✓ LEVEL OVER TIME
- ✓ MER OVER TIME
- ✓ BER OVER TIME
- DQI OVER TIME
- ✓ UPSTREAM - 5 BONDED
- ✓ TRANSMIT OVER TIME
- ✓ UPSTREAM ICFR
- UPSTREAM EQ ANALYSIS
- ✓ REGISTRATION
- THROUGHPUT
- PING / TRACEROUTE
- PACKET QUALITY

Configure Display Channel Search Stop

Channel	Freq (MHz)	Level (dBmV)	MER (dB)
67	483.000	12.1	42.4
68	489.000	12.5	42.2
69	495.000	12.6	41.9
71	507.000	12.9	42.7
72	513.000	12.9	42.7
73	519.000	13.2	42.2
74	525.000	13.2	42.5
75	531.000	13.1	42.7
76	537.000	13.2	42.0

DOCSIS Expert

✓ DASHBOARD

✓ DOCSIS (100 %) Status: Connected

32x (1x OFDM) | Downstream

Forward TPC: 0.0 dB
Min Rx: 12.1 dBmV Min MER: 35.9 dB
Max BER: 1.0e-9 (pre) Max MER: 43.8 dB

Upstream | 5x

Max Tx: 46.8 dBmV Max ICFR: 1.4 dB

+0.0 dB TPC Work Order - Test Name

✓ DOWNSTREAM - 32 BONDED

513.000 MHz

Annex B | 256 QAM | 5.361 Msym/s | 6.000 MHz

Level	MER	BER	BER
13.0 dBmV	42.7 dB	1.0e-9 Pre	1.0e-9 Post
Echo: -42.4 dBc	GD: 24 ns	ICFR: 0.3 dB	DQI: 10.0

Channel Freq (MHz) Level (dBmV) MER (dB)

DOCSIS Expert

DOCSIS Expert

+0.0 dB TPC Work Order - Test Name

- ✓ DOWNSTREAM - 32 BONDED
- ✓ LEVEL OVER TIME
- ✓ MER OVER TIME
- ✓ BER OVER TIME
- ✓ DQI OVER TIME
- ✓ UPSTREAM - 5 BONDED
- ✓ TRANSMIT OVER TIME
- ✓ UPSTREAM ICFR
- UPSTREAM EQ ANALYSIS
- ✓ REGISTRATION
- THROUGHPUT
- PING / TRACEROUTE
- PACKET QUALITY

Configure Display Channel Search **Stop**

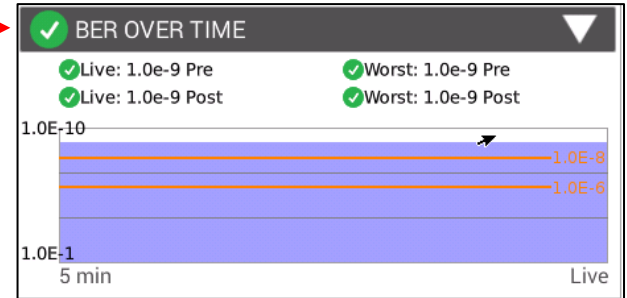
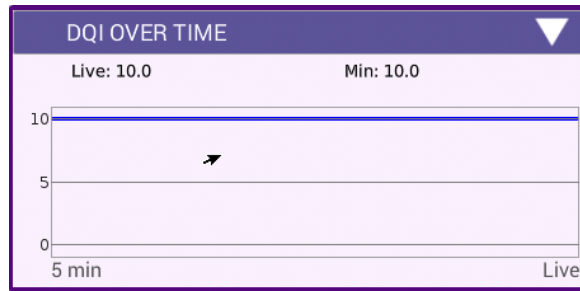
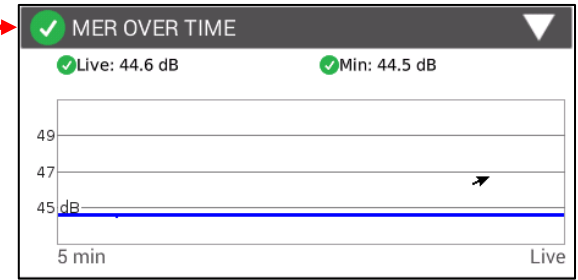
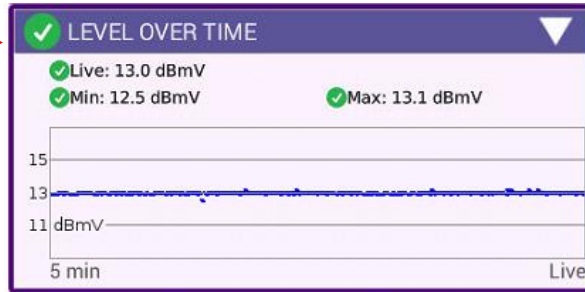

DOCSIS Expert

DOCSIS Expert

+0.0 dB TPC Work Order - Test Name

- DOWNSTREAM - 32 BONDED
- LEVEL OVER TIME
- MER OVER TIME
- BER OVER TIME
- DQI OVER TIME
- UPSTREAM - 5 BONDED
- TRANSMIT OVER TIME
- UPSTREAM ICFR
- UPSTREAM EQ ANALYSIS
- REGISTRATION
- THROUGHPUT
- PING / TRACEROUTE
- PACKET QUALITY

Configure Display Channel Search Stop

UPSTREAM - 5 BONDED

Reference bandwidth: Modem Default

UCD 4 | 16.400 MHz
64 QAM | 6.400 MHz | ATDMA

UCD	Freq (MHz)	Level (dBmV)	ICFR (dB)
4	16.400	46.5	0.8
3	22.800	46.8	0.8
2	29.200	46.3	0.6
1	35.600	45.8	0.7
9	39.600	46.5	1.4

TRANSMIT OVER TIME

Live: 46.5 dBmV
Min: 46.5 dBmV Max: 46.5 dBmV

5 min Live

UPSTREAM EQ ANALYSIS

Channel:		EQ Tap:	
Frequency:	16.400 MHz	Time:	0.20 μ s
TX Level:	46.5 dBmV	Level:	-29.8 dBc
Bandwidth:	6.4 MHz	Distance:	79.7 ft
		VOP:	0.830

DOCSIS Expert

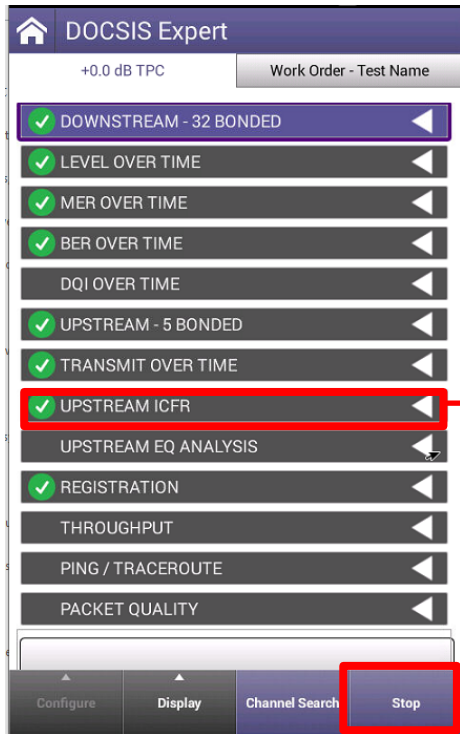

DOCSIS Expert

+0.0 dB TPC Work Order - Test Name

- ✓ DOWNSTREAM - 32 BONDED
- ✓ LEVEL OVER TIME
- ✓ MER OVER TIME
- ✓ BER OVER TIME
- DQI OVER TIME
- ✓ UPSTREAM - 5 BONDED
- ✓ TRANSMIT OVER TIME
- ✓ UPSTREAM ICFR**
- UPSTREAM EQ ANALYSIS
- ✓ REGISTRATION
- THROUGHPUT
- PING / TRACEROUTE
- PACKET QUALITY

Configure Display Channel Search **Stop**

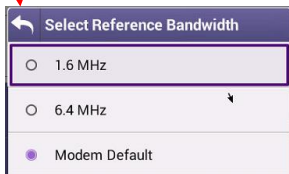
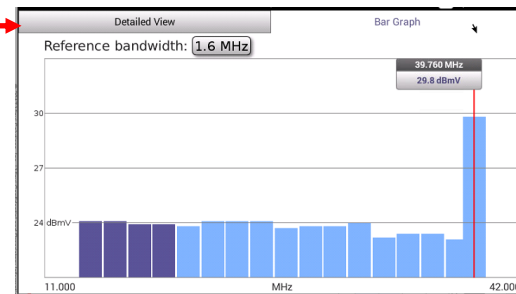
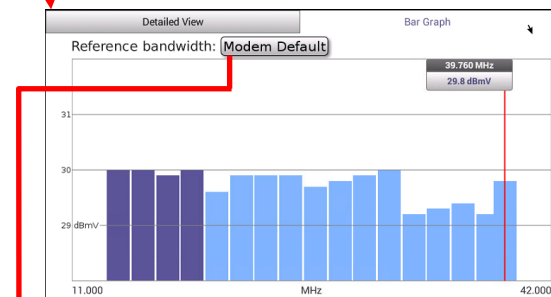
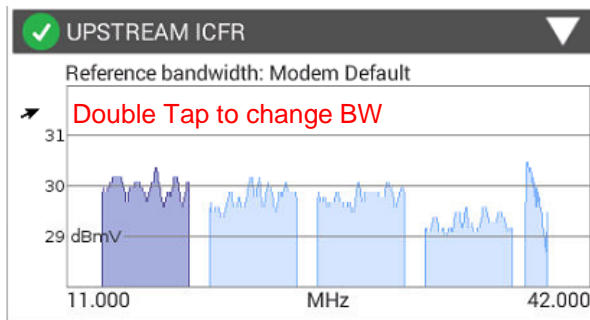

Select Reference Bandwidth

- 1.6 MHz
- 6.4 MHz
- Modem Default

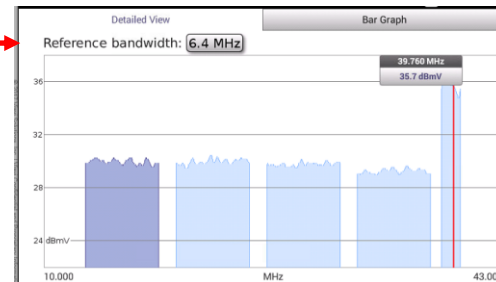

DOCSIS Expert

DOCSIS Expert

+0.0 dB TPC Work Order - Test Name

- DOWNSTREAM - 32 BONDED
- LEVEL OVER TIME
- MER OVER TIME
- BER OVER TIME
- DQI OVER TIME
- UPSTREAM - 5 BONDED
- TRANSMIT OVER TIME
- UPSTREAM ICFR
- UPSTREAM EQ ANALYSIS
- REGISTRATION
- THROUGHPUT
- PING / TRACEROUTE
- PACKET QUALITY

Configure Display Channel Search Stop

REGISTRATION

Service Plan: 00:07:11:1F:8C:12
Config File: d11_walledgarden_v6.cm

Cable Modem

Provisioning Mode: IPV6 ONLY
 IPv6 Address: 2001:558:40a2:42:207:11ff:fe1f8c12/128
 IPv6 Gateway Address: fe80::201:5cff:feb2:3046
 IPv6 Config File: d11_walledgarden_v6.cm

CPE

IPv4 Address: 98.226.73.212
 IPv4 Subnet Mask: 255.255.248.0
 IPv4 Gateway Address: 98.226.72.1

Servers

IPv6 TFTP Server: fe80::201:5cff:feb2:3046
 IPv6 DHCP Server: fe80::201:5cff:feb2:3046
 IPv6 TOD Server: fe80::201:5cff:feb2:3046

THROUGHPUT

THROUGHPUT (100 %)

Downstream URL: http://spt01mtpkca.mtpk.ca.charter.com/mtpkr2D2wh3reRuN0w.iso
 Upstream URL: http://spt01mtpkca.mtpk.ca.charter.com/mtpkr2D2wh3reRuN0w.iso

1.19 Gbps 42.30 Mbps
 RTT: 19 ms RTT: 19 ms

Receive Send

Configure Start Throughput

PING / TRACEROUTE

	Current	Minimum	Average	Maximum
Delay (ms)	0	0	0	0
Destination	98.226.72.1			
Echoes Sent	10			
Replies Returned	0			
Replies Lost	10			
Replies Lost %	100.00%			
Error				

PACKET QUALITY

Packet Loss: 299 Sent 0.0 % Loss

Max Round Trip Delay: 26 ms

Max Jitter: 19 ms

Stop Packet Quality

Start Pass Through Cable Modem

DOCSIS Expert Configure



DOCSIS Expert Configure Settings

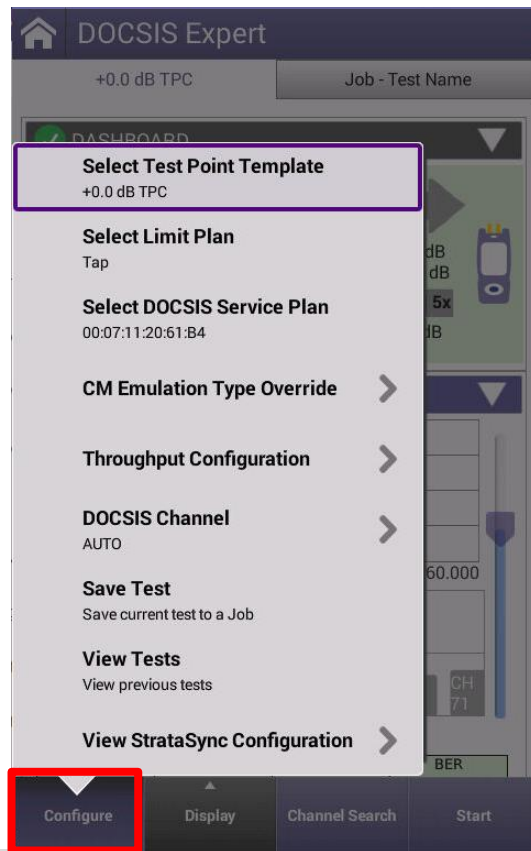

DOCSIS Expert Configure Settings

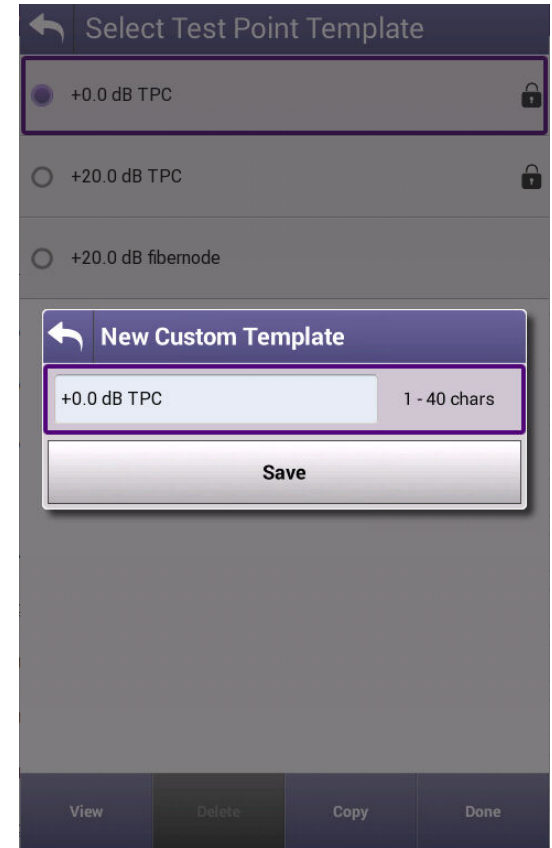
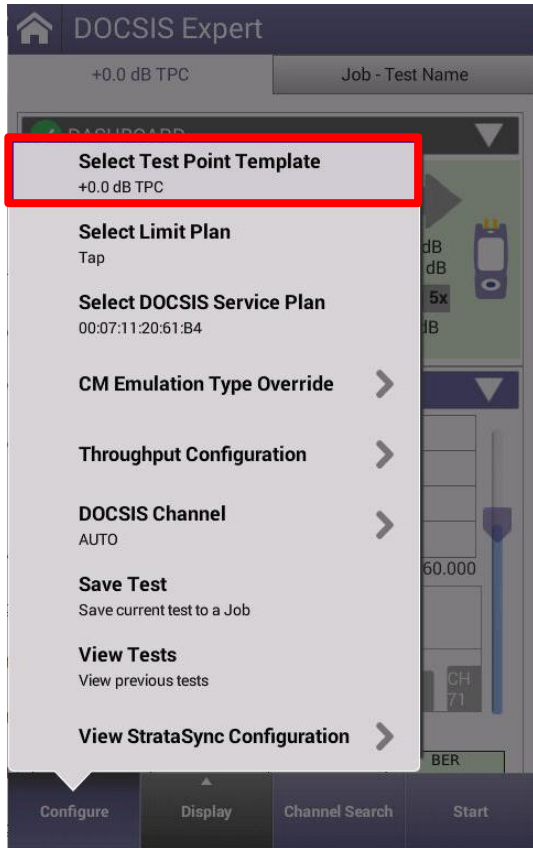

DOCSIS Expert Configure Settings

DOCSIS Expert

+0.0 dB TPC Job - Test Name

DASHBOARD

Select Test Point Template
+0.0 dB TPC

Select Limit Plan
Tap

Select DOCSIS Service Plan
00:07:11:20:61:B4

CM Emulation Type Override >

Throughput Configuration >

DOCSIS Channel >
AUTO

Save Test
Save current test to a Job

View Tests
View previous tests

View StrataSync Configuration >

Configure Display Channel Search Start

Select Limit Plan

Tap

Ground Block

CPE

Select DOCSIS Service Plan

00:07:11:1F:8C:12

00:07:11:1F:8C:13

00:07:11:1F:8C:14

00:07:11:1F:8C:15

00:07:11:1F:8C:16

Select CM Emulation Type

DOCSIS 3.0 8x4

DOCSIS 3.0 16x4

DOCSIS 3.0 24x4

DOCSIS 3.0 32x8

DOCSIS 3.1 32x8

CM Emulation Type

Override Cable Modem emulation type

CM Emulation Type
DOCSIS 3.0 8x4

DOCSIS Expert Configure Settings

Upstream

Throughput Settings

Override DOCSIS Service Plan
Override applies only to current Work Order.

Enter an Upstream URL

Upload Throughput URL
http://CATVSpeedTest.viavisolutions.com

Or select from list

00:07:11:1F:8C:12	http://CATVSpeedTest.viavisolutions.com
00:07:11:1F:8C:13	http://CATVSpeedTest.viavisolutions.com
00:07:11:1F:8C:14	http://CATVSpeedTest.viavisolutions.com
00:07:11:1F:8C:15	http://CATVSpeedTest.viavisolutions.com
00:07:11:1F:8C:16	http://CATVSpeedTest.viavisolutions.com

Upstream Address **Downstream Address**

Downstream

Throughput Settings

Override DOCSIS Service Plan
Override applies only to current Work Order.

Enter a Downstream URL

Downstream Throughput URL
http://CATVSpeedTest.viavisolutions.com/bigfile.zip

Or select from list

00:07:11:1F:8C:12	http://CATVSpeedTest.viavisolutions.com/bigfile.zip
00:07:11:1F:8C:13	http://CATVSpeedTest.viavisolutions.com/bigfile.zip
00:07:11:1F:8C:14	http://CATVSpeedTest.viavisolutions.com/bigfile.zip
00:07:11:1F:8C:15	http://CATVSpeedTest.viavisolutions.com/bigfile.zip
00:07:11:1F:8C:16	http://CATVSpeedTest.viavisolutions.com/bigfile.zip

Upstream Address **Downstream Address**

DOCSIS Expert

+0.0 dB TPC Job - Test Name

DASHBOARD

- Select Test Point Template
+0.0 dB TPC
- Select Limit Plan
Tap
- Select DOCSIS Service Plan
00:07:11:20:61:B4
- CM Emulation Type Override >
- Throughput Configuration >**
- DOCSIS Channel
AUTO >
- Save Test
Save current test to a Job
- View Tests
View previous tests
- View StrataSync Configuration >

Configure Display Channel Search Start

DOCSIS Expert Configure Settings

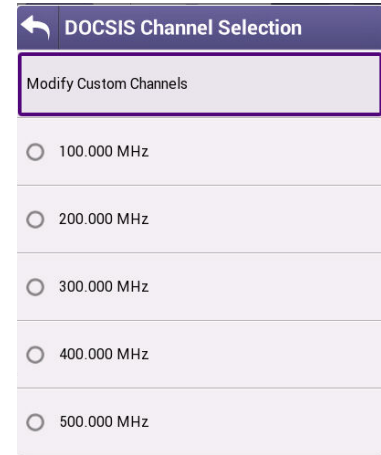
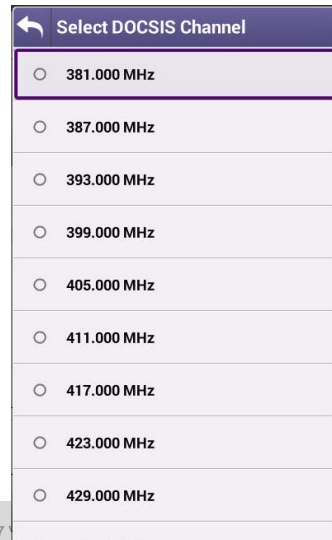
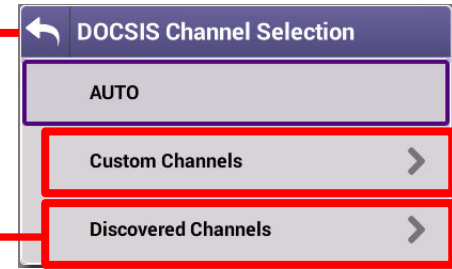
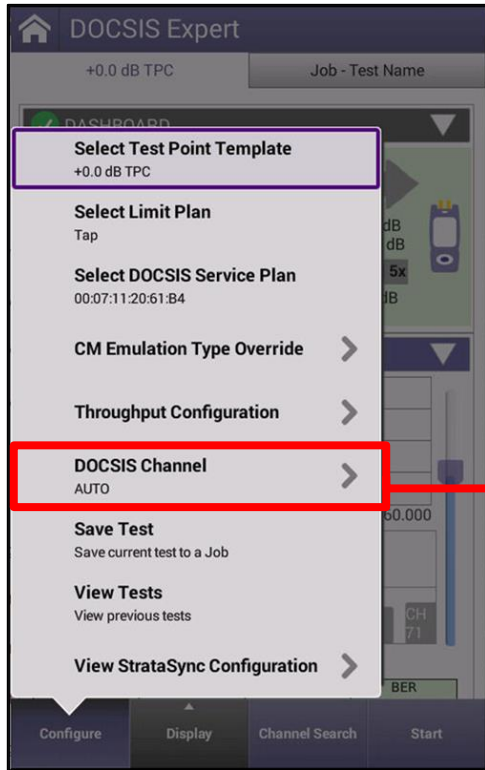

DOCSIS Expert Configure Settings

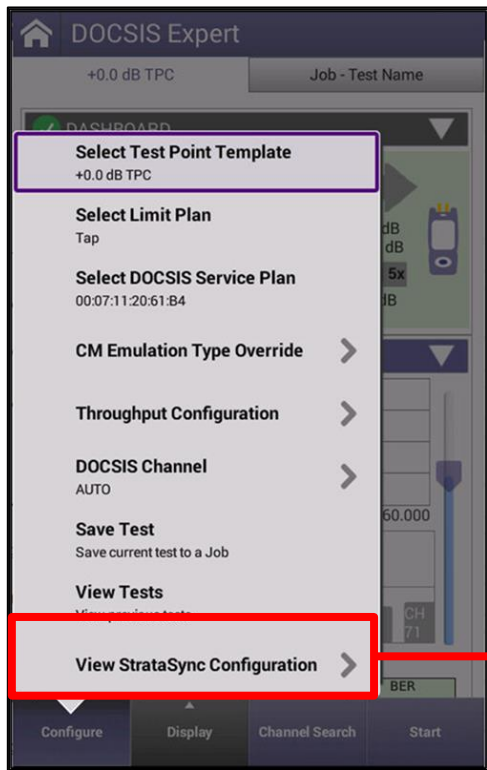

Channel Plan
AUTO

View StrataSync Configuration >

StrataSync Configuration

Limit Plan File Name
timlevel

Limit Plan Exclusion Zone File Name
Newtestonxofdm

Return Signal Generator (RSG) w/ Loopback

Getting Started with RSG Loopback

- RFG Loopback mode will appear in the CATV Network section on the ONX home screen
- To enter the mode press, or select, the RFG Loopback icon

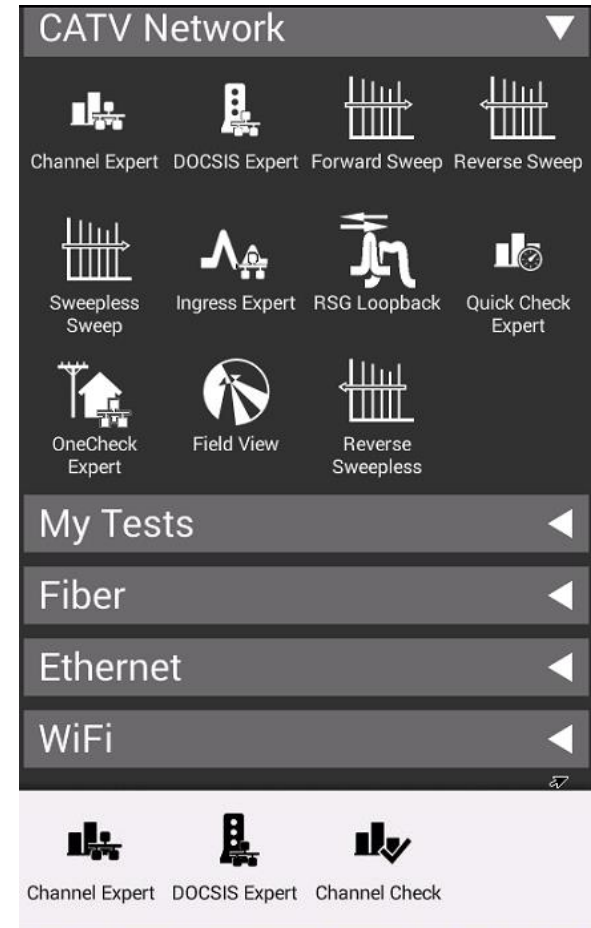
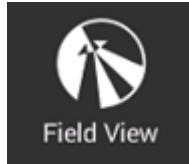

RSG Loopback

Return Signal Generator Loopback

Signal Transmit OFF MODE: Tx ONLY

Freq (MHz)	Level (dBmV)
------------	--------------

Configure Mode Start

The main screen shows a table for configuring carriers. The 'Configure' button at the bottom left is highlighted with a red box.

Carrier Configuration
Configure a Carrier

A button with a right-pointing arrow, highlighted with a red box.

Carrier Configuration

Signal Type
CW

Carriers:

Add Carrier Edit Carrier Remove Carrier Back

The 'Carrier Configuration' screen shows the signal type set to CW. The 'Add Carrier' button at the bottom left is highlighted with a red box.

Select Signal Type

CW

QAM

The 'Select Signal Type' dialog shows CW selected. A red line connects this dialog to the 'Frequency' dialog below.

Frequency

40 5.000 MHz - 85.000 MHz

OK

The 'Frequency' dialog shows the frequency set to 40 MHz. A red line connects this dialog to the 'Level' dialog below.

Level

40.00 dBmV

OK

The 'Level' dialog shows the level set to 40.00 dBmV. A red line connects this dialog back to the 'Carrier Configuration' screen.

RSG Loopback

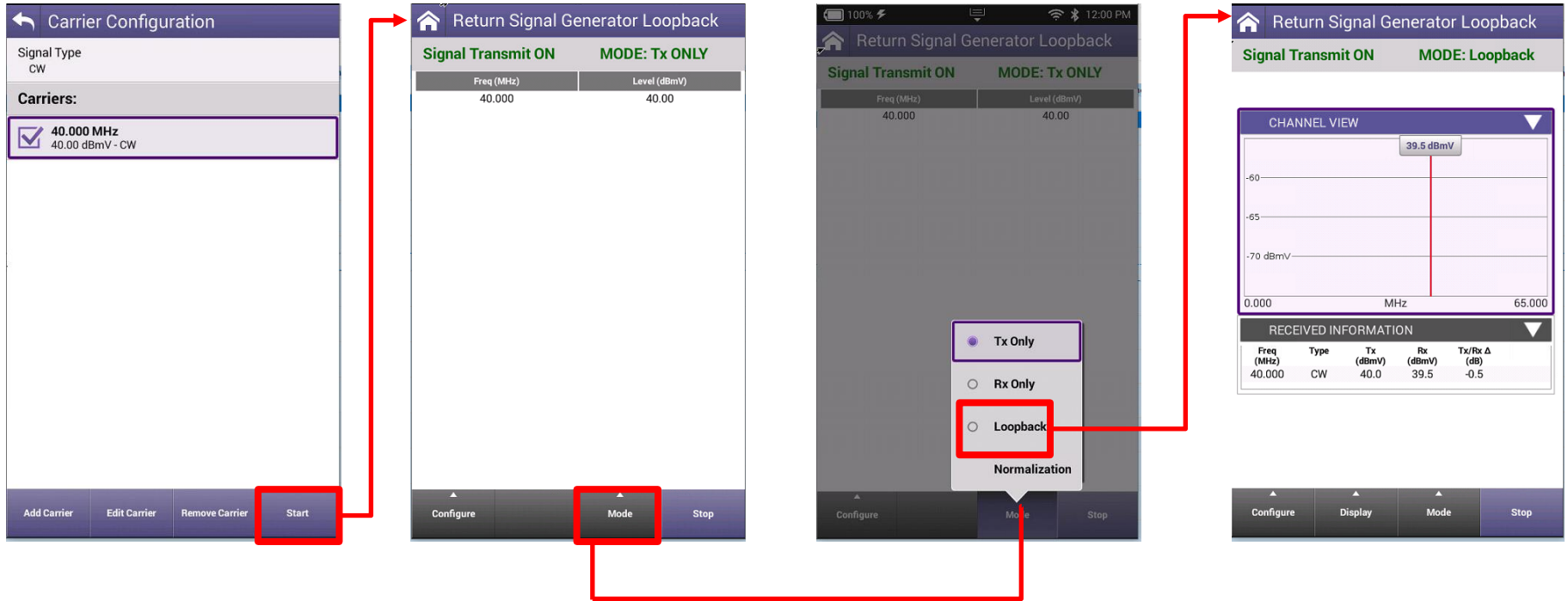

Field View with RSG

A night cityscape, likely Dubai, with a network overlay of white lines and glowing nodes. The overlay consists of several bright white nodes connected by thin white lines, forming a complex network pattern over the city lights. The background is a dark blue gradient with a large white triangle on the left side.

Ingress/Noise Mitigation Test Process

- Ingress/noise in the upstream path is very common and impacts subscriber services
- Ingress/noise can be constant, or intermittent
 - If ingress/noise is constant, and tech fixes an issue at a local test point, did that clean up the ingress/noise received in the headend, or is there still another issue at some other point in the network?
 - If ingress is intermittent, and spectrum is clean, tech doesn't know whether there is no ingress at this particular point, or the ingress isn't happening at this time
- Meter spectrum mode enables tech to test upstream spectrum only at their local test point

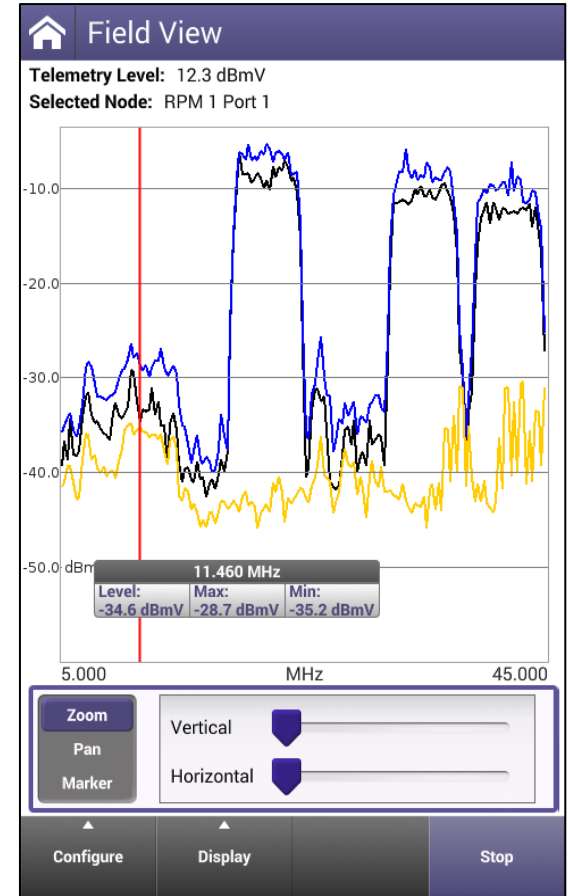

Getting Started with Field View

- If enabled on the ONX, Field View mode will appear in the CATV Network section on the ONX home screen
- To enter the mode press, or select, the Field View icon

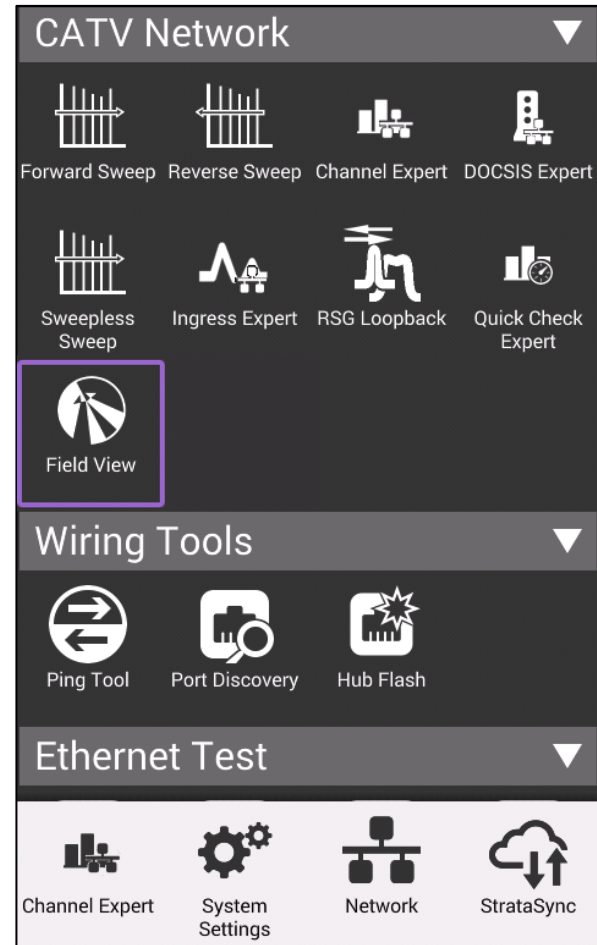
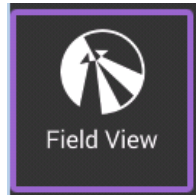

Using Field View

- Field View is the remote view of the headend return path on an instrument located in the field
- Isolates the noise source
- Using the remote display of the headend the tech can quickly confirm if actions taken are improving the network or if additional work is needed
- When an interfering ingress source is removed, the noise present at the headend will drop out revealing a lower noise floor at the headend
- A lower system noise floor eases demodulation of upstream carriers for the CMTS and leads to a better quality of experience for subscribers

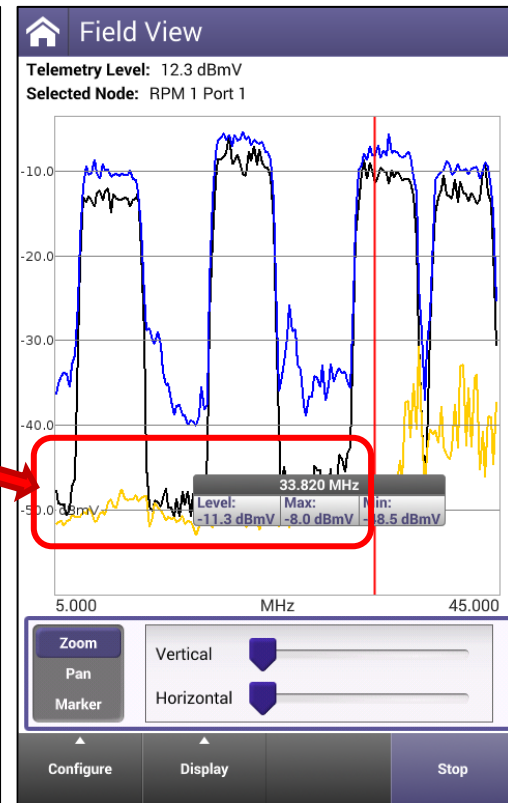
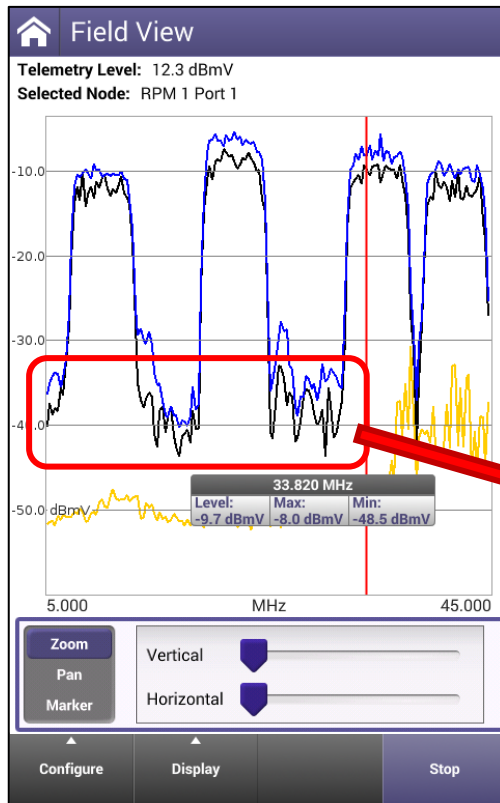

Left: Noise visible between the active upstream carriers
Right: Noise source cleaned up reveals a much lower system noise floor

Setting Field View Telemetry Receive Frequency

- An HSM connected to PathTrak at the headend is required for Field View
- The HSM sends a telemetry signal downstream for field devices, like the ONX or DSAM, providing visibility of the return spectrum remotely
- The telemetry receive frequency is entered on the ONX by pressing the Configure button then selecting “Configure Telemetry”
- This will bring up an entry box where the telemetry frequency can be entered

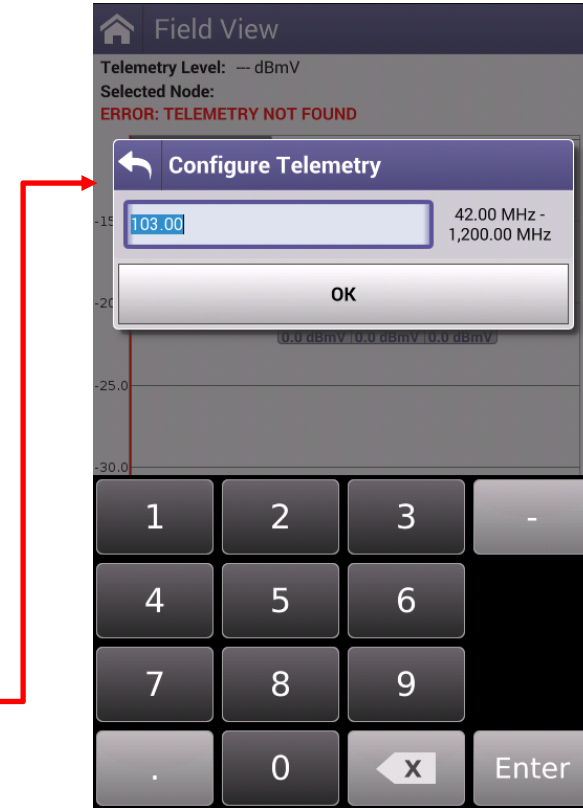
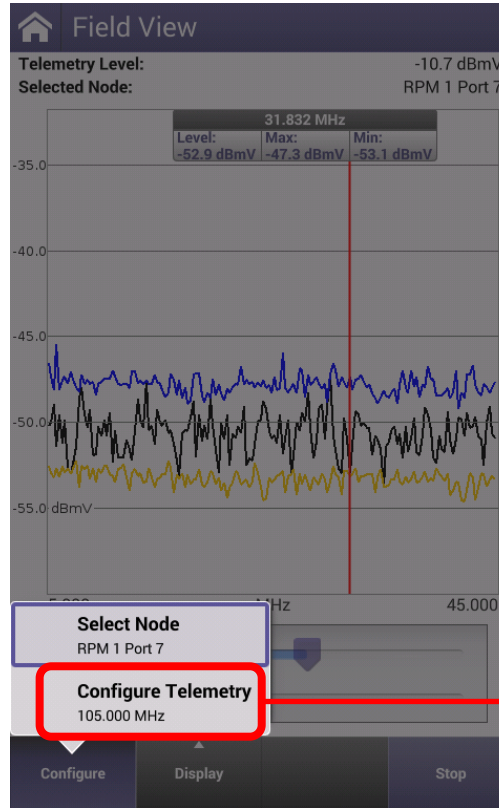

Field View Node Selection and Information

- Users can select the desired node from the list of actively broadcasting nodes from the PathTrak system
- Users can also get details of the specific broadcasting nodes

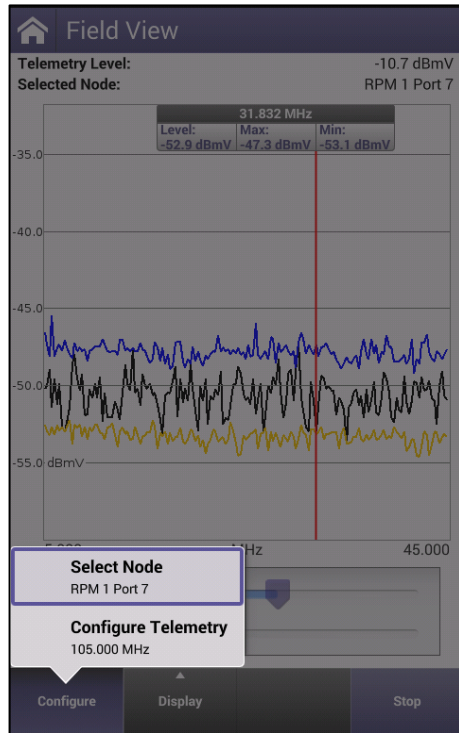

The screenshot shows the 'All Nodes' list. The nodes are listed with their status: RPM 1 Port 2 (Inactive), RPM 1 Port 3_renamed (Active), RPM 1 Port 4 (Inactive), RPM 1 Port 5 (Active), RPM 1 Port 6 (Inactive), RPM 1 Port 7 (Active and selected with a checkmark), RPM 1 Port 8 (Inactive), RPM 2 Port 1 (Inactive), RPM 2 Port 2 (Inactive), RPM 2 Port 3 (Inactive), RPM 2 Port 4 (Inactive), and RPM 2 Port 5 (Inactive). The bottom navigation bar includes 'Node Info', 'Show Active Nodes', and 'Select Node' buttons.

Node Name	Status
RPM 1 Port 2	Inactive
RPM 1 Port 3_renamed	Active
RPM 1 Port 4	Inactive
RPM 1 Port 5	Active
RPM 1 Port 6	Inactive
✓ RPM 1 Port 7	Active
RPM 1 Port 8	Inactive
RPM 2 Port 1	Inactive
RPM 2 Port 2	Inactive
RPM 2 Port 3	Inactive
RPM 2 Port 4	Inactive
RPM 2 Port 5	Inactive

The screenshot shows the 'Node Information' screen for the selected node, RPM 1 Port 7. The status is 'Broadcasting'. The table below provides detailed information:

Broadcasting	
Name	RPM 1 Port 7
UID	332
Center Frequency	25.000 MHz
Span	40.000 MHz
Dwell	100 μ s
Points	161
VBW	100 KHz
RBW	300 KHz

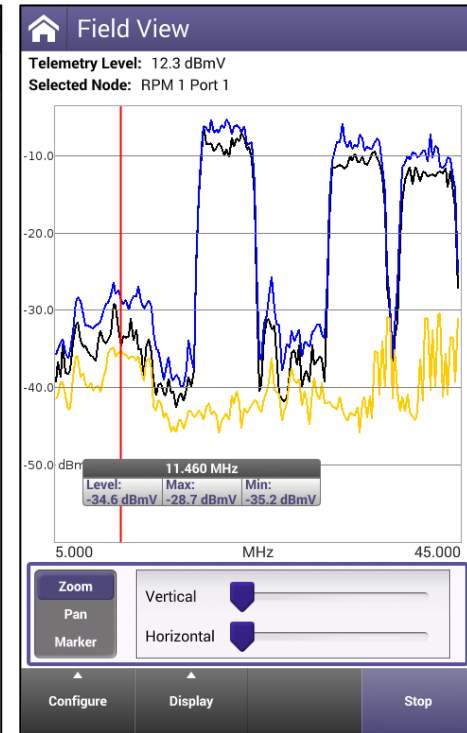

FieldView RSG Transmit Carriers

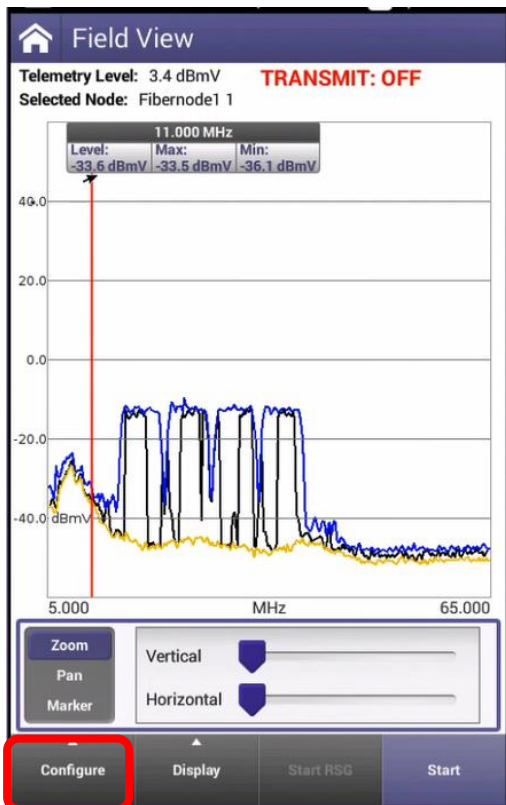

- Select Node
- Configure Telemetry
103.000 MHz
- Carrier Configuration**
Configure transmit carriers
- Normalize
Perform Normalization

Carrier Configuration

Signal Type
CW

Carriers:

- 5.000 MHz
15.00 dBmV - CW

Bottom Bar: Add Carrier, Edit Carrier, Remove Carrier, Done

Add Carrier

Frequency
42.000 MHz

Level
40.00 dBmV

OK

Field View RSG Transmit Carriers

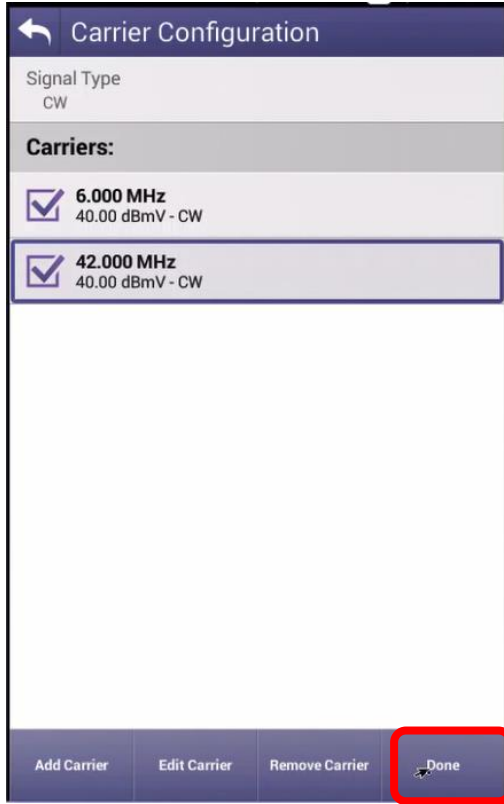

Carrier Configuration

Signal Type
CW

Carriers:

- 6.000 MHz
40.00 dBmV - CW
- 42.000 MHz
40.00 dBmV - CW

Bottom bar: Add Carrier, Edit Carrier, Remove Carrier, Done

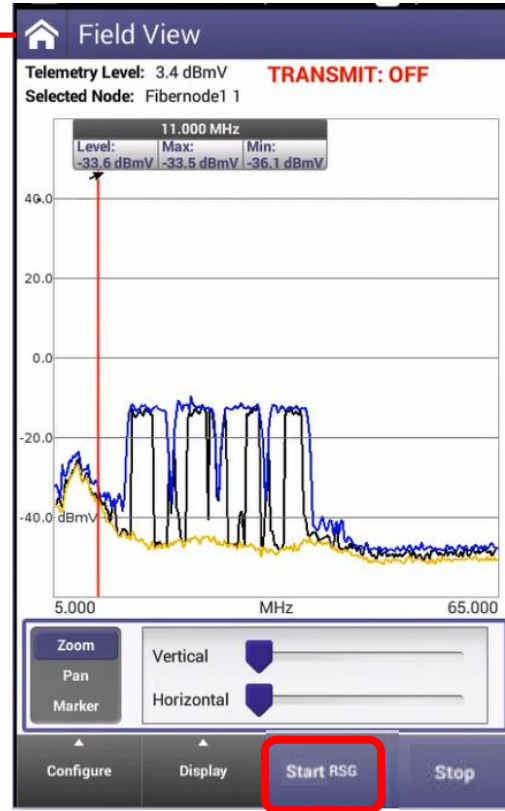

Field View

Telemetry Level: 3.4 dBmV **TRANSMIT: OFF**

Selected Node: Fibernode1 1

11.000 MHz		
Level:	Max:	Min:
-33.6 dBmV	-33.5 dBmV	-36.1 dBmV

Graph: dBmV vs MHz (5.000 to 65.000)

Bottom bar: Configure, Display, Start RSG, Stop

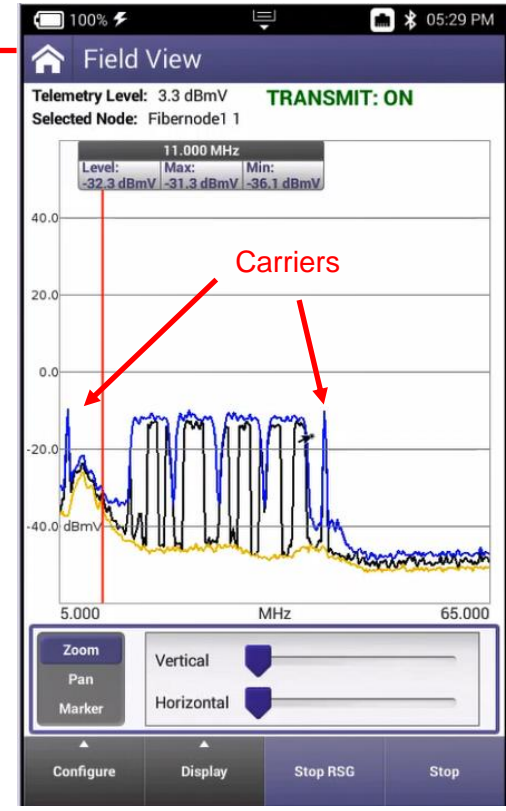

Field View

Telemetry Level: 3.3 dBmV **TRANSMIT: ON**

Selected Node: Fibernode1 1

11.000 MHz		
Level:	Max:	Min:
-32.3 dBmV	-31.3 dBmV	-36.1 dBmV

Graph: dBmV vs MHz (5.000 to 65.000)

Red arrows labeled "Carriers" point to the signal peaks in the graph.

Bottom bar: Configure, Display, Stop RSG, Stop

Field View Normalization

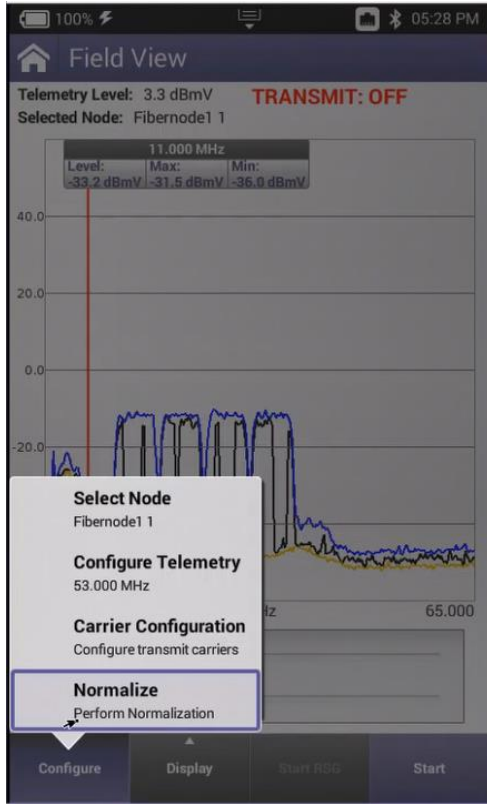

The screenshot shows the 'Normalization' screen. At the top, it says 'Normalization'. Below this, it displays the status:

Status:
Last Normalization Time:
January 02, 2019 02:37:24 PM

In the center, there is a diagram of a purple handheld meter with a loop antenna. Below the diagram, the text reads:

Normalization is required for accurate results.
Connect a short cable between port 1 and port 2 of the meter and press Start.

At the bottom right, there is a 'Start' button.

The screenshot shows the 'Normalization' screen. At the top, it says 'Normalization'. Below this, it displays the status:

Status: Completed Successfully
Last Normalization Time:
September 25, 2020 02:13:28 PM

In the center, there is a diagram of a purple handheld meter with a loop antenna. Below the diagram, the text reads:

Normalization is required for accurate results.
Connect a short cable between port 1 and port 2 of the meter and press Start.

At the bottom right, there is a 'Start' button.

OneCheck Expert Configure Settings

Getting Started with OneCheck Expert

OneCheck Expert mode will appear in the CATV Network section on the ONX home screen

To enter the mode press, or select, the OneCheck Expert icon

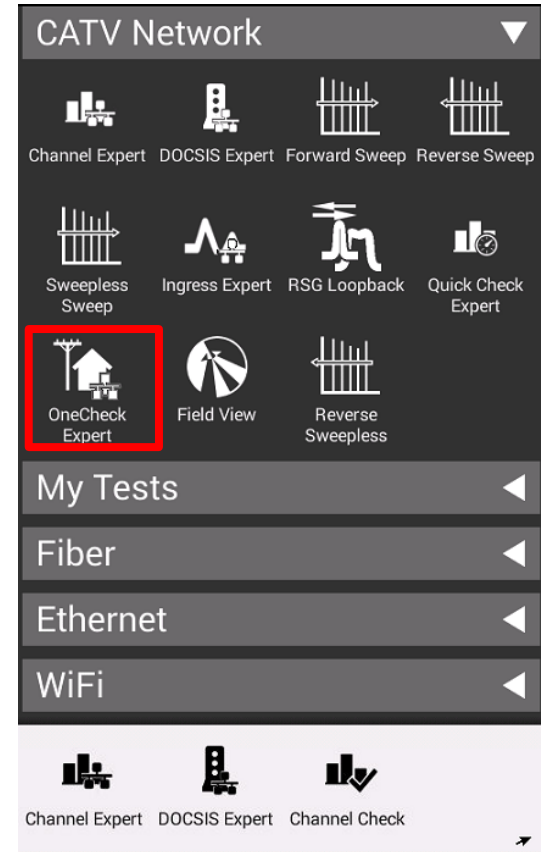
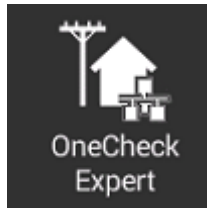

OneCheck Expert

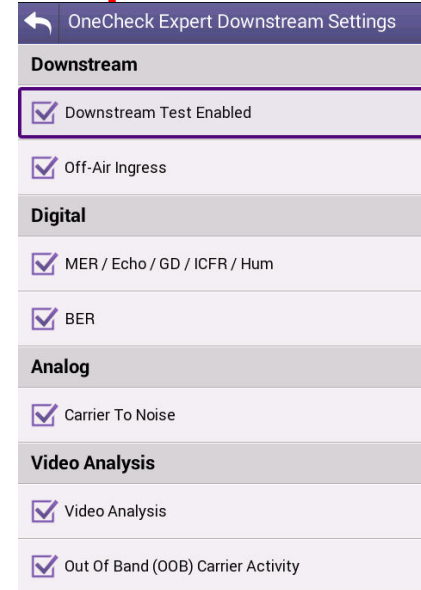
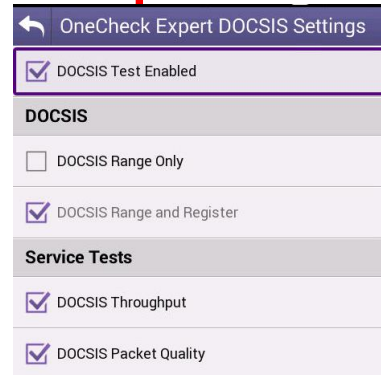
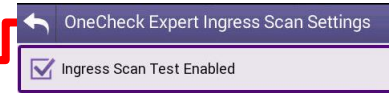
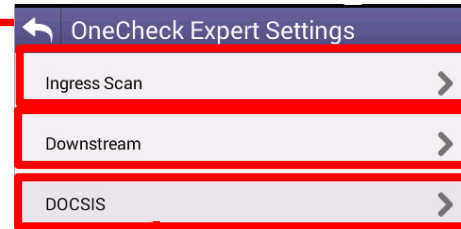
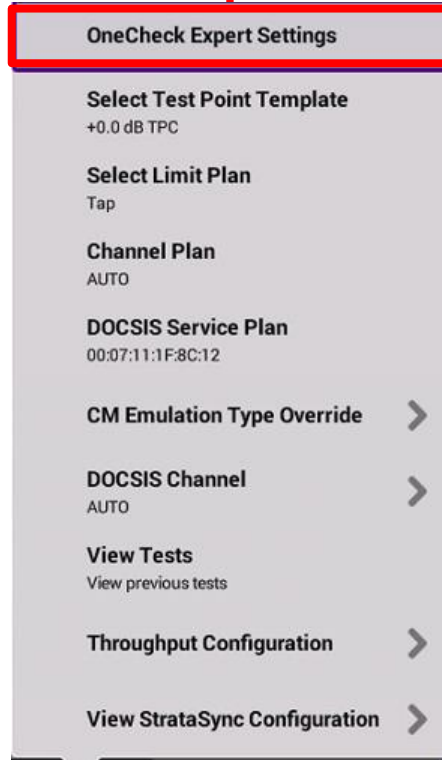
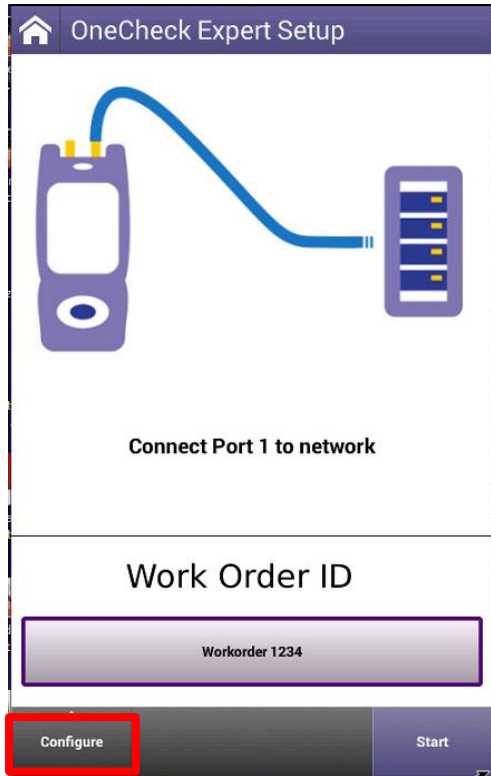

OneCheck Expert

OneCheck Expert Settings

Select Test Point Template
+0.0 dB TPC

Select Limit Plan
Tap

Channel Plan
AUTO

DOCSIS Service Plan
00:07:11:1F:8C:12

CM Emulation Type Override >

DOCSIS Channel >
AUTO

View Tests
View previous tests

Throughput Configuration >

View StrataSync Configuration >

Select Test Point Template

+0.0 dB TPC

+20.0 dB TPC

line extender

Select Limit Plan

Tap

Ground Block

CPE

Head End

Select Channel Plan

AUTO

Select DOCSIS Service Plan

00:07:11:1F:8C:12

00:07:11:1F:8C:13

00:07:11:1F:8C:14

00:07:11:1F:8C:15

00:07:11:1F:8C:16

OneCheck Expert

OneCheck Expert Settings

Select Test Point Template
+0.0 dB TPC

Select Limit Plan
Tap

Channel Plan
AUTO

DOCSIS Service Plan
00:07:11:1F:8C:12

CM Emulation Type Override >

DOCSIS Channel >

View Tests
View previous tests

Throughput Configuration >

View StrataSync Configuration >

CM Emulation Type

Override Cable Modem emulation type

CM Emulation Type
DOCSIS 3.0 8x4

Select CM Emulation Type

DOCSIS 3.0 8x4

DOCSIS 3.0 16x4

DOCSIS 3.0 24x4

DOCSIS 3.0 32x8

DOCSIS 3.1 32x8

DOCSIS Channel Selection

AUTO

Custom Channels >

Discovered Channels >

Select DOCSIS Channel

381.000 MHz

387.000 MHz

393.000 MHz

399.000 MHz

405.000 MHz

411.000 MHz

417.000 MHz

423.000 MHz

429.000 MHz

DOCSIS Channel Selection

Modify Custom Channels

100.000 MHz

200.000 MHz

300.000 MHz

400.000 MHz

500.000 MHz

OneCheck Expert

OneCheck Expert Settings

Select Test Point Template
+0.0 dB TPC

Select Limit Plan
Tap

Channel Plan
AUTO

DOCSIS Service Plan
00:07:11:1F:8C:12

CM Emulation Type Override >

DOCSIS Channel >
AUTO

View Tests
View previous tests

Throughput Configuration >

View StrataSync Configuration >

Throughput Settings

Override DOCSIS Service Plan
Override applies only to current Work Order.

Enter an Upstream URL

Upload Throughput URL
http://CATVSpeedTest.viavisolutions.com

Or select from list

00:07:11:1F:8C:12	http://CATVSpeedTest.viavisolutions.com
00:07:11:1F:8C:13	http://CATVSpeedTest.viavisolutions.com
00:07:11:1F:8C:14	http://CATVSpeedTest.viavisolutions.com
00:07:11:1F:8C:15	http://CATVSpeedTest.viavisolutions.com
00:07:11:1F:8C:16	http://CATVSpeedTest.viavisolutions.com

Upstream Address Downstream Address

StrataSync Configuration

Limit Plan File Name
MER

DOCSIS Service Plan File Name
default-docsisprofiles

Off Air Ingress Plan File Name
default-oiplans

Measurement Settings File Name
default-measurementssettings

Limit Plan Exclusion Zone File Name
default-exclusionzones

Ingress Expert

Ingress Expert

CATV Network

Channel Expert DOCSIS Expert Forward Sweep Reverse Sweep

Sweepless Sweep **Ingress Expert** RSG Loopback Quick Check Expert

OneCheck Expert Field View Reverse Sweepless

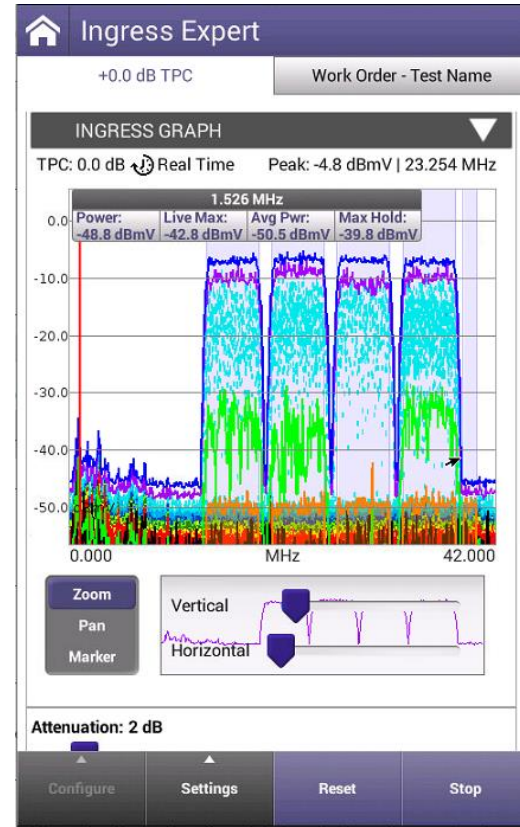

INGRESS EXPERT

INGRESS EXPERT is based on powerful OneExpert CATV HyperSpectrum technology (Real Time Spectrum Analyzer)

Innovative overlapping FFT (Fast Faurier transform) measures all transient interfering signals

INGRESS EXPERT is different from Swept Spectrum Analyzers (DSAM and Pathtrak) – its more accurate and has thousands of samples a second

Overlapping options provide additional detail

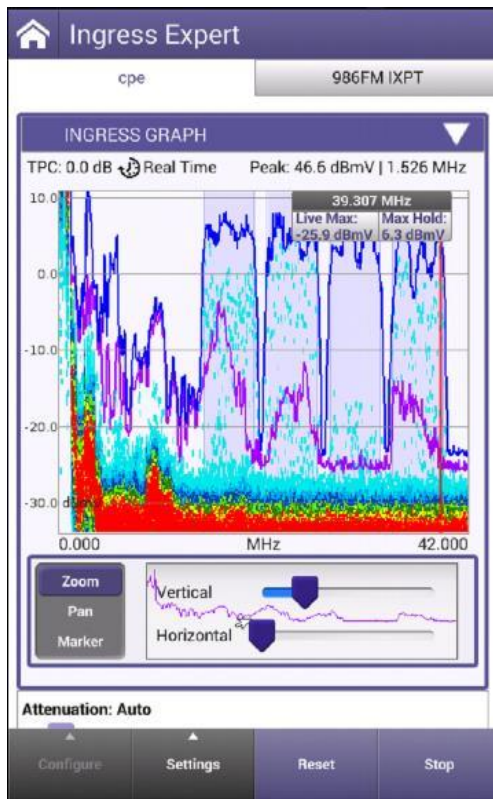

ONX630

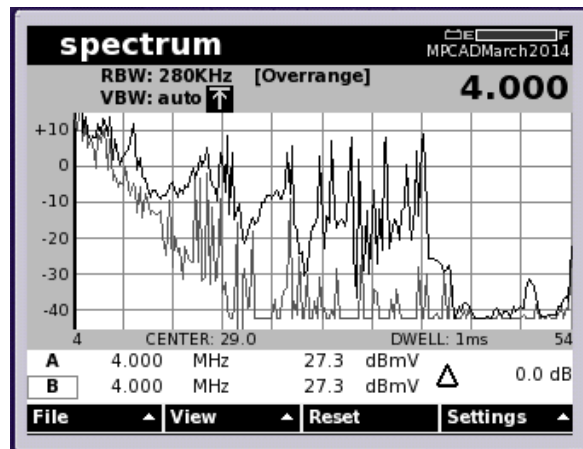

DSAM6300

INGRESS EXPERT - CONFIGURE

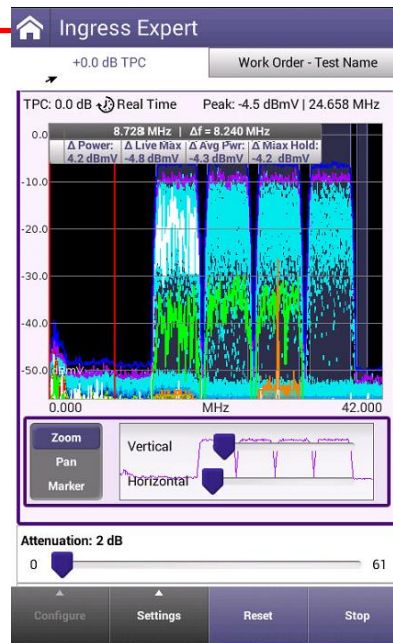
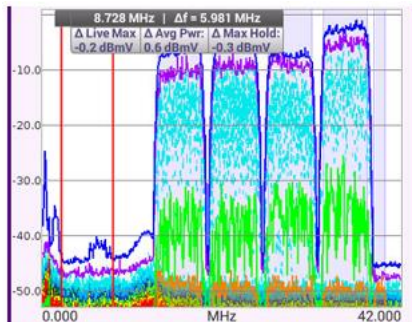
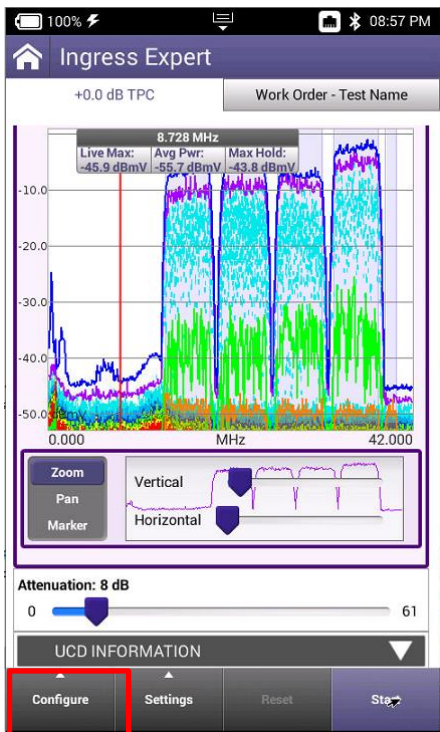

- Delta Markers
- Dark Mode
- Rotate Screen
Portrait
- Traces and Heatmap
- Auto AGC

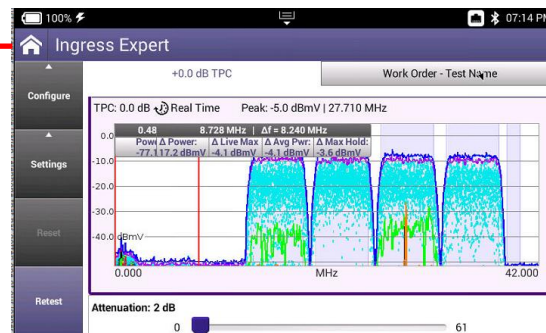

INGRESS EXPERT – HEATMAP OVERLAYS

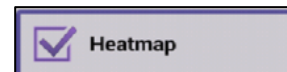
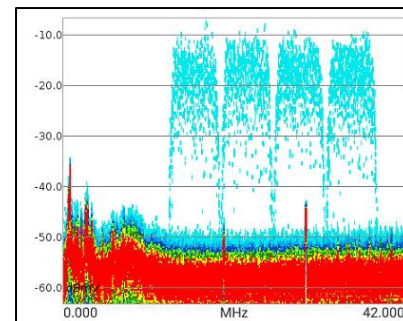
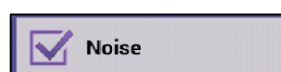
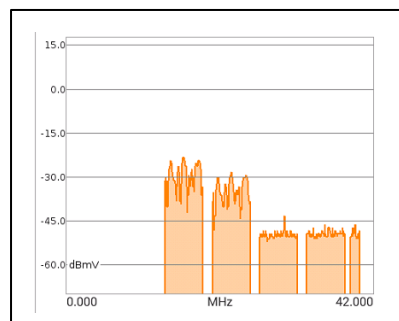
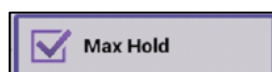
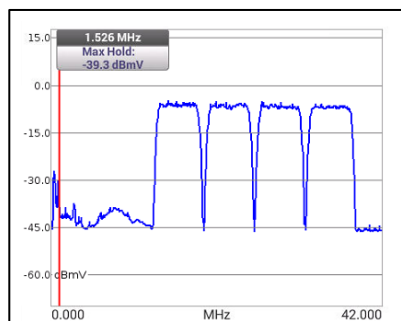
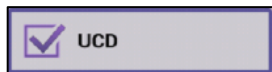
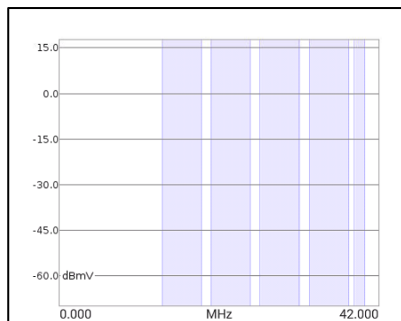
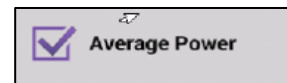
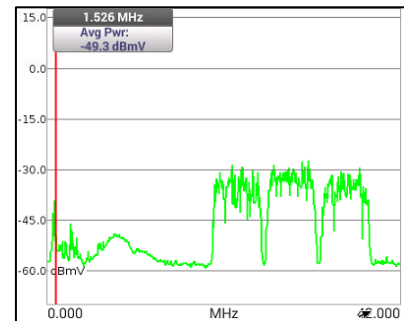
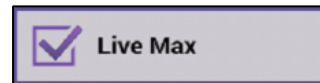
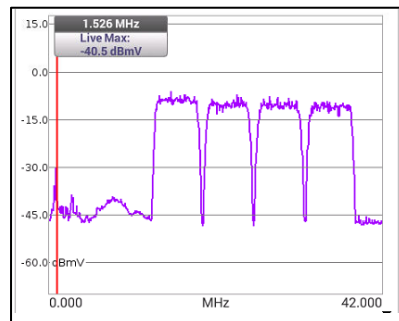
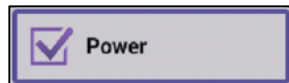
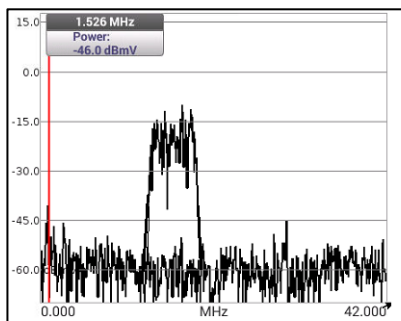
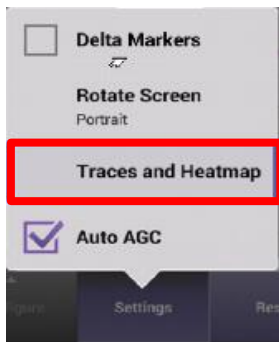

INGRESS EXPERT – AUTO-ACG

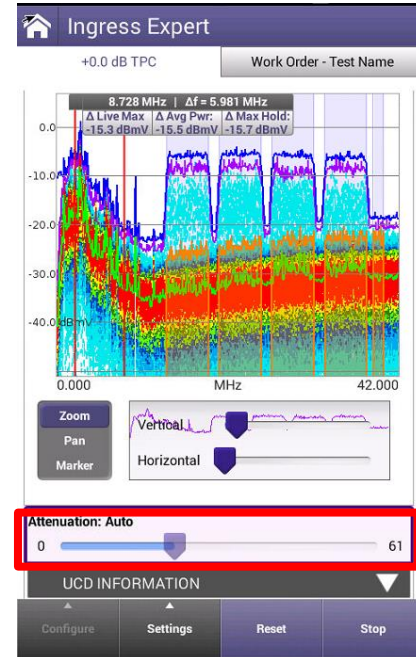
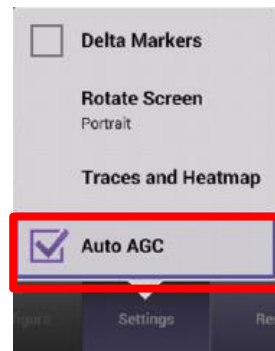
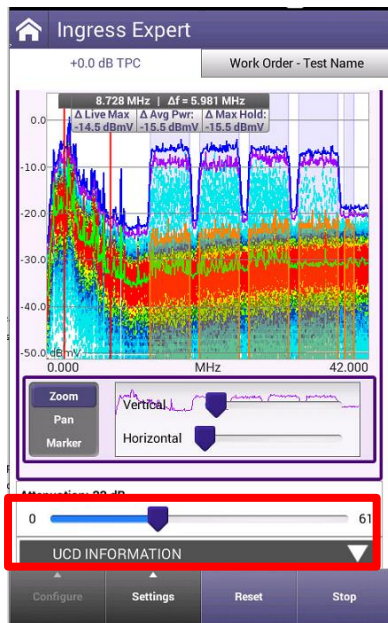
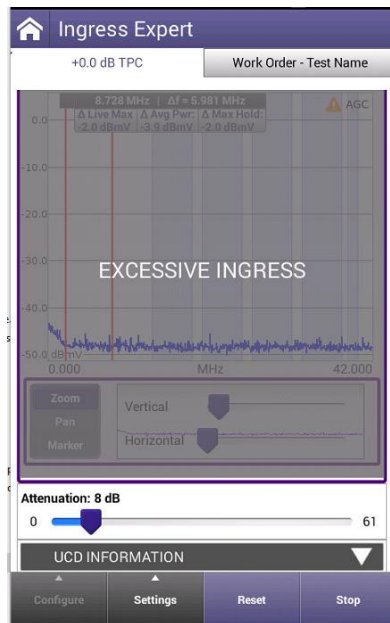
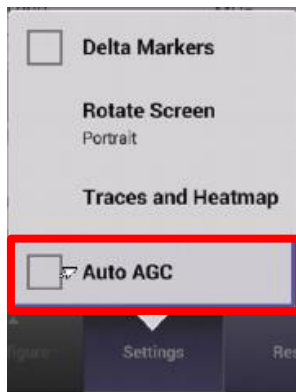

- DISABLING AUTO AGC requires the user manually attenuates the signal to prevent OVERRANGE
- NOTE: The spectrum Specification is 120 MHZ

- AUTO AGC will attempt keep spectrum view references, up to 60dB dynamic range
- NOTE: The Attenuation scale is disabled when AGC is checked

INGRESS EXPERT - CONFIGURE

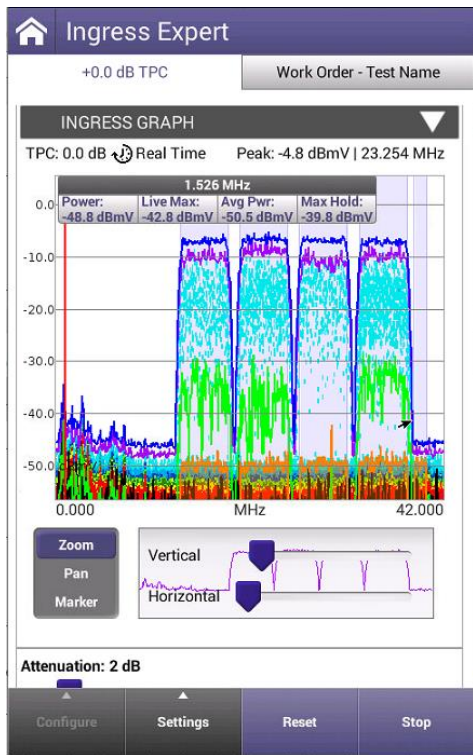

Select Test Point Template
+0.0 dB TPC

Select High Frequency
42.000 MHz - Real Time

Select Heatmap Persistence
Low

Save Test
Save current test to a Work Order

View Tests
View previous tests

View StrataSync Configuration

View Test Results

Tests for Current Work Order:
Tap noise

+0.0 dB TPC
+20.0 dB TPC
line extender

Select Span High Frequency
42.000 MHz Real Time
65.000 MHz Real Time
85.000 MHz Real Time
110.000 MHz Real Time

Select Heatmap Persistence
Low
Medium
High

Save Test
Save Test to Work Order
Test Name
Tap noise
Work Order ID
Workorder 1234

StrataSync Configuration
Test Point Templates File Name
default-testpoint-templates

INGRESS EXPERT – SNR and NOISE

- The NOISE setting will allow users to see the noise floor under the upstream carriers
- If the user performs a DOCSIS EXPERT test before INGRESS EXPERT, UCDs will match that of the network and give clear indication of the carriers width and location
- Additionally, UCDs will be demodulated with FREQUENCY, LEVEL and SNR calculated and displayed

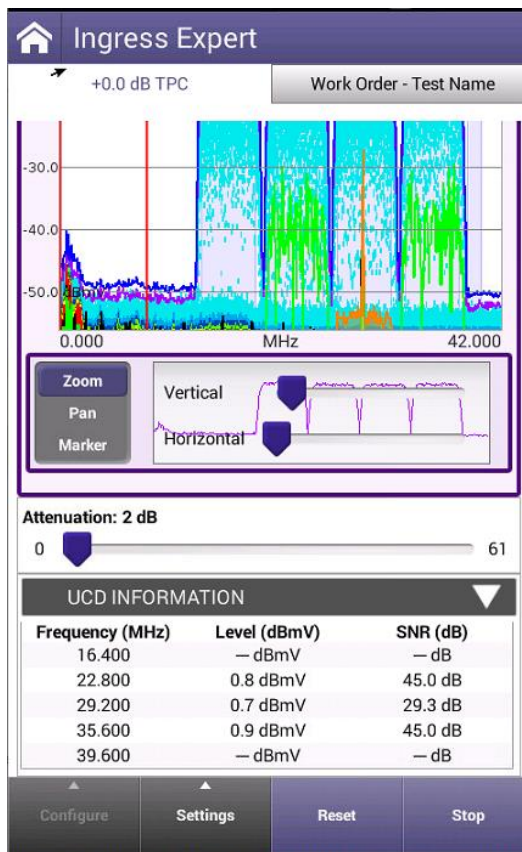



**Sweep & Plant Maintenance System
ONX-630 & SCU-1800**

SCU-1800

Advanced System Sweep

- **Fast** — Sweep, align, and troubleshoot faster than ever
- **Stealth Sweep™** with integrated Tilt/Align quickly validates amps and HFC networks faster than any other test
- Complete a downstream scan including MER/ BER in about 60 seconds
- **AutoChannel™** instantly identifies the channel lineup and eliminates guesswork
- **Powerful** — Designed to find difficult problems
- Combined DOCSIS 3.1 and sweep testing validates the complete HFC network
- **Ingress Expert** with Hyper Spectrum™ catches difficult return noise problems
- **Expert modes** with advanced parallel processing find hidden problems and root causes
- **Flexible** — Ready for your changing network needs
- The ONX-630's **dual diplexer** 42/85 or 65/204 with 1.2GHz supports next generation networks
- The ONX-630 is compatible with DSAM-6300 and SDA-55XX providing seamless transition
- Common sweep reporting for ONX-630 and DSAM ensures consistency via **StrataSync™**

Next Generation Sweep Gear

OneExpert CATV ONX-630

- Field upgradable: Sweep + DOCSIS 3.1 module
- Reverse Sweep capable to 204MHz
→ compatible with SDA-5500/5510
- Extended Forward Sweep range to 1.2GHz with new SCU-1800



ONX-630

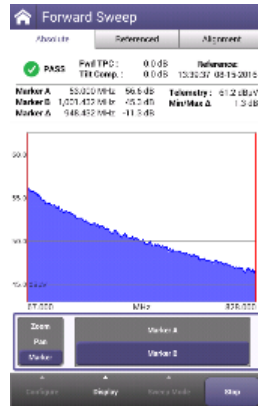

Sweep Control Unit SCU-1800

- 1RU unit with Ethernet interface (web browser/remote)
- Compatible with DSAM-6300
- Forward TX to 1.2GHz with ONX
 - HW capable up to 1.8GHz
 - 50dB Spurious Free Range
 - Narrow Sweep Pulses – fit between carriers
- Sixteen switchable return sweep ports (sw optional)
- Flexible mode of operation
 - Forward Tx only (5500)
 - Forward + Single User Reverse (5500)
 - Multi-User Reverse (5510)

SCU-1800 Appearance



SCU-1800 Sweep Transmitter/Receiver

- The headend/hub rack-mounted SCU-1800 Sweep Control Unit provides non-interfering downstream sweep to 1.218 GHz and upstream sweep to 204 MHz on up to 16 ports.
- The sweep is remotely configurable via Ethernet and browser, and a sweep plan can be built from imported information from the **OneExpert ONX**
- Additionally, there is an auto-fill capability in which the sweep points are automatically injected in unoccupied spectrum areas.

SCU-1800 Field Unit Compatibility

SDA / DSAM sweep type

Forward Sweep

- 50 to 1000 MHz

Reverse Sweep

- 5 to 85 MHz
- Single User Reverse
- Multi User Optional

▪ ONX sweep type

Forward sweep

- 54 to 1218 MHz
- -20 to +20 dBmV input range

Reverse Sweep

- 5 to 204 MHz frequency Range
- -20 to +20 dBmV input level range

SCU - Forward Sweep

- Uses downstream plant and inserted carriers
- Up to 500 sweep points
- Future proof with 1800 MHz capable hardware
- SDA Protocol

SCU - Reverse Sweep Inputs

- 16 isolated inputs
- Manual select standard
- Optional Auto input select

Frequency Range

- 5 to 204 MHz
- SDA Protocol

Typical SCU-1800 Connection diagram

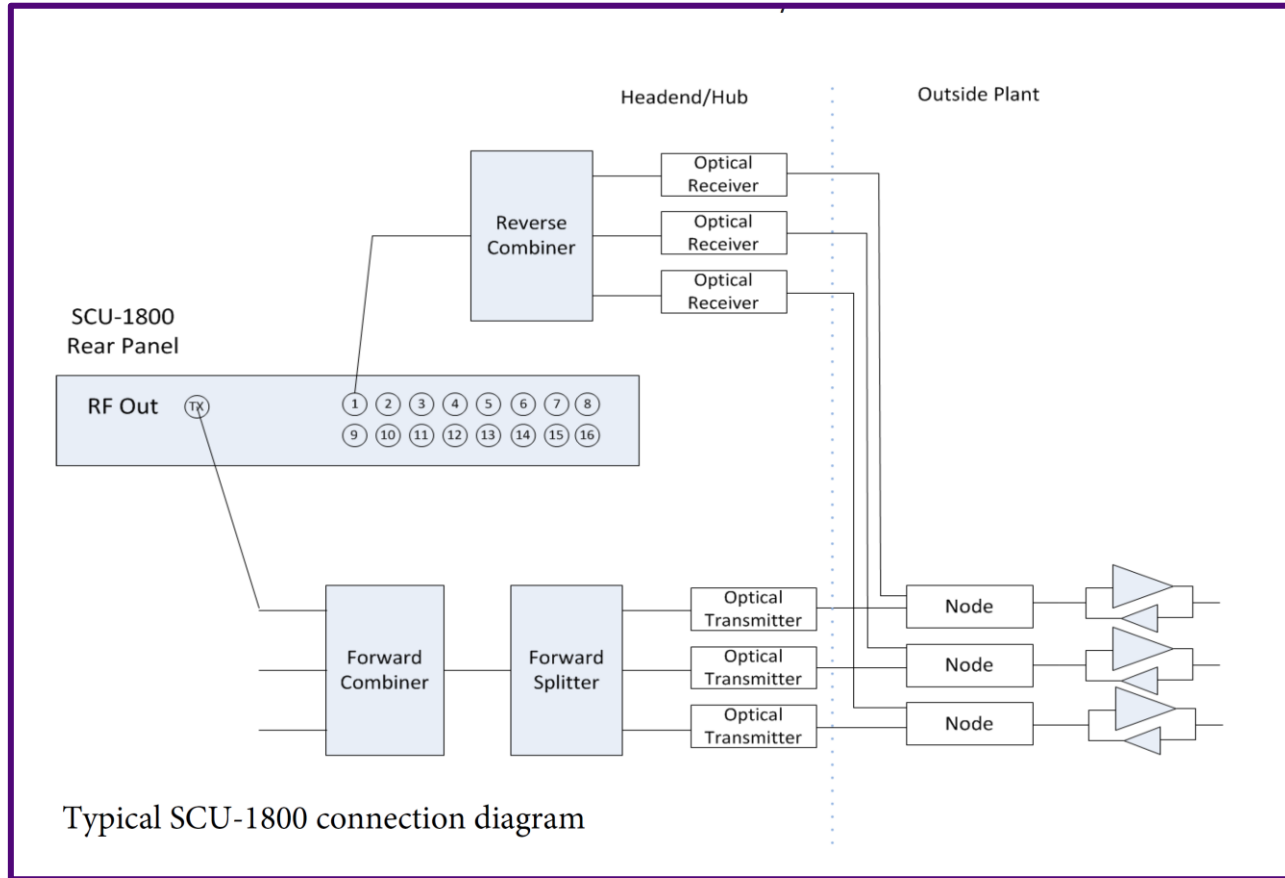

Typical SCU-1800 connection diagram

Sweep Beyond 1GHz

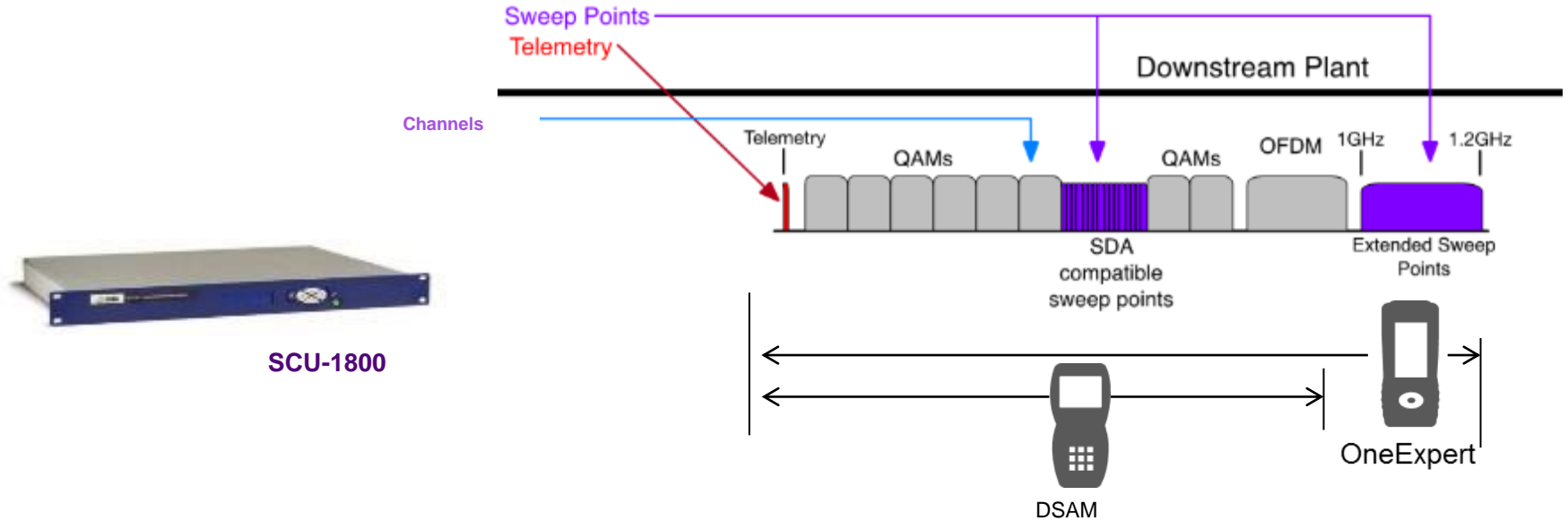

SCU-1800

- ONX coupled with new Sweep Control unit can provide sweep to 1.2GHz and beyond
- DSAM units on same system are still compatible up to 1GHz.

(New) Reverse Sweep to 204 MHz

SCU-1800

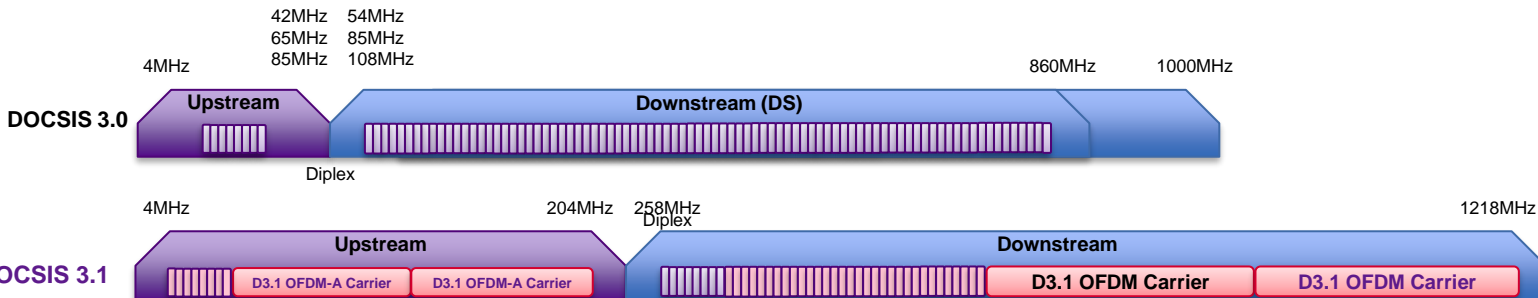
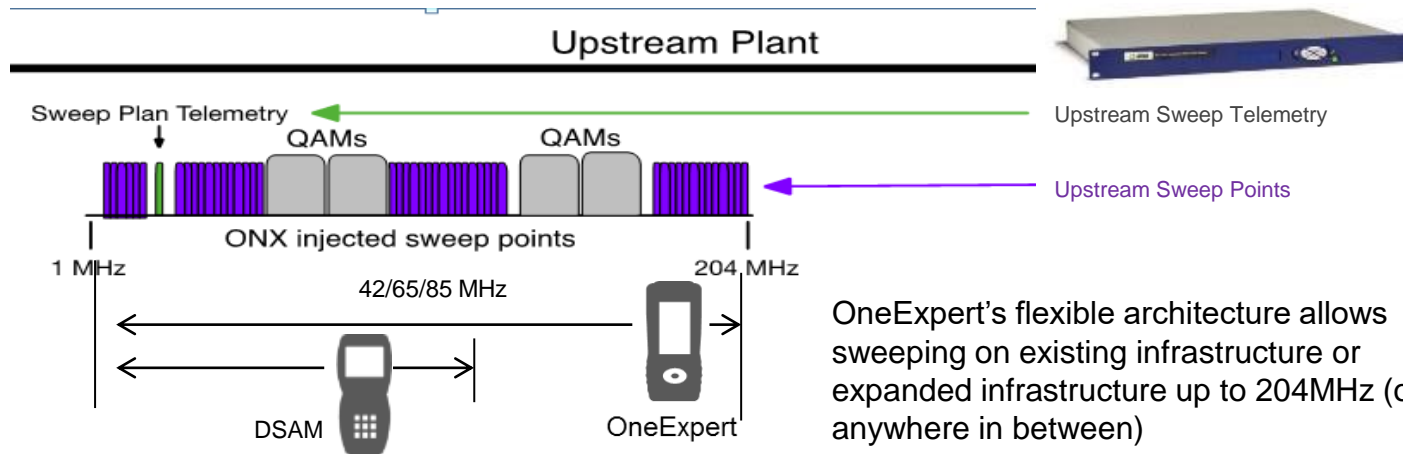

Configure Sweep Remotely

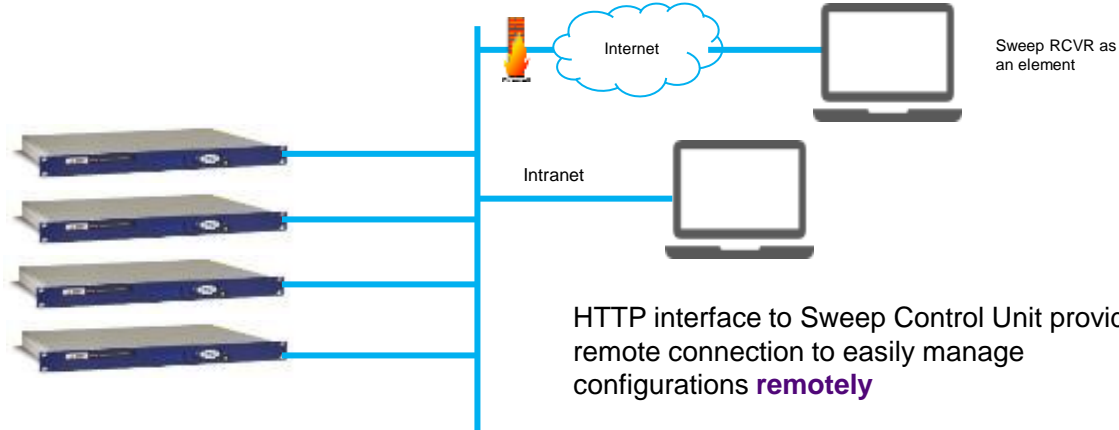

HTTP interface to Sweep Control Unit provides remote connection to easily manage configurations **remotely**

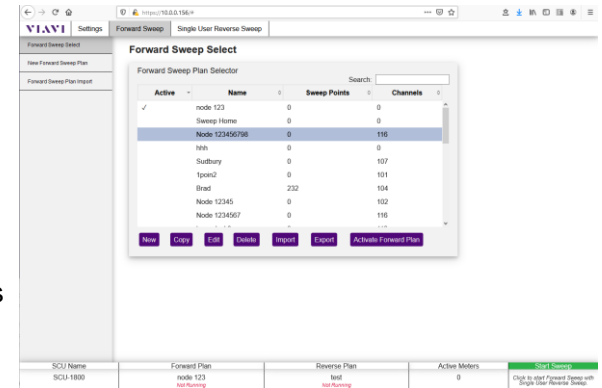

Configure Sweep Locally from a laptop



HTTP interface to Sweep Control Unit provides easy access to configurations **locally**

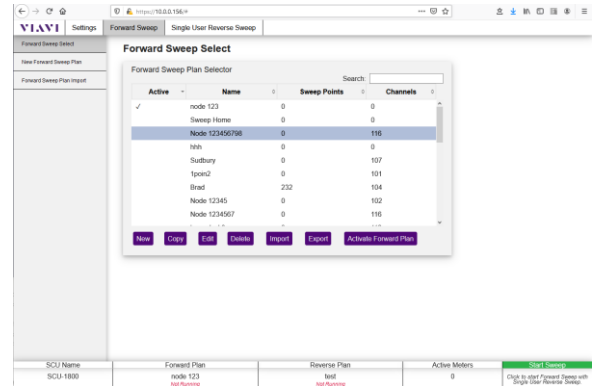

Multiple reverse sweep input ports

Reduces costs and improves performance

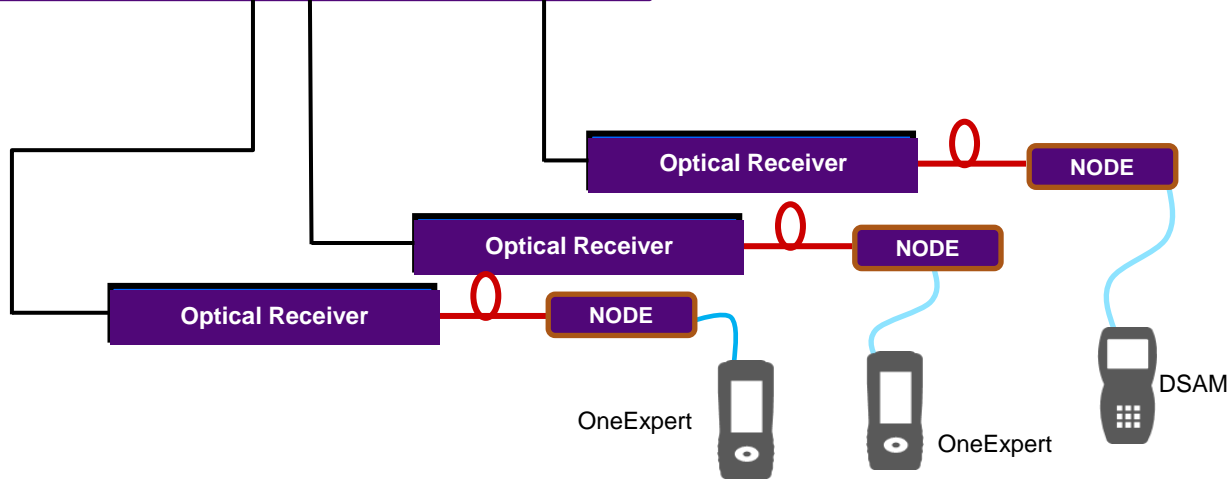

- ✓ Integrated 16 port capability (SW optional)
- ✓ Provides improved performance
 - ✓ Less combining
 - ✓ Improved noise floor
- ✓ Saves costs
 - ✓ Reduced rack space
 - ✓ Consolidation of sweep receivers

Sweep Specifications

- **Telemetry**

- Frequency Range: 42 to 1,218 MHz
- Frequency Resolution: 10 kHz
- Modulation FSK : ± 100 kHz deviation; 65 kbps
- Output Level: +20 to +50 dBmV, 1 dB resolution, 0.5dB accuracy typical, 1 dB accuracy over temp
- Spectral Purity: 50 dBc harmonics and spurious; recommend 1 MHz space from SC QAM edge

- **Sweep Pulse**

- Frequency Range: 42 to 1,218 MHz
- Bandwidth: <5 kHz @ 3dB BW; <50 kHz @ 50dB BW
- Frequency Resolution: 10 kHz
- Level : +20 to +50 dBmV, 1 dB resolution, 0.5dB accuracy typical, 1 dB accuracy over temp
- Spectral Purity: 50 dBc harmonics and spurious; recommend 1 MHz space from SC QAM edge

- **Forward Sweep**

- Telemetry frequency: Diplexer dependent 50-1,218MHz
- Forward sweep outputs: Up to 500 sweep points
- Supported Sweep Plan Active Carrier types (for reference and measurement by the field instrument) Analog (NTSC, PALB, PAL GH, PAL I, PAL DK,) Digital (6 or 8MHz), OFDM (24-192MHz),

- **Reverse Sweep**

- Frequency Range: 5 to 204 MHz
- Recommended input level: 0 dBmV
- Input range and accuracy: ± 20 dBmV allowable input range; ± 0.75 dB typical; ± 2 dB over temp
- Minimum Signal-to-Noise Ratio: 20 dB signal-to-noise ratio required on received reverse telemetry from field meters
- Reverse Sweep points injection: +20 to+50 dBmV
- Reverse Telemetry Level: +20 to+50 dBmV

SCU-1800 Settings

Test Point Compensation

Reverse Sweep Test Point Compensation

Port	TPC(dB)
1	0
2	0
3	0
4	0
5	0
6	0
7	0
8	0
9	0
10	0
11	0
12	0
13	0
14	0
15	0
16	0

Apply TPC to Reverse Telemetry Level

[Submit Query](#)

Sweep Settings

Forward Telemetry Frequency (MHz) 51

Forward Telemetry Level (dBmV) 20

Forward Sweep Level (dBmV) 20

Reverse Telemetry Frequency (MHz) 10

Automatically start sweep at power on

[Submit Query](#)

Firmware

Firmware Package Version
5.0.391

Firmware Details

Firmware Upgrade

[Browse...](#) No file selected.

[Upgrade Firmware](#)

General Settings

Signal Level Units dBmV

Device Name SCU-1800

HTTPS Enabled

Demo Mode Forward Sweep

[Submit Query](#)

SCU-1800 Settings

Options

Current Options

Catalog Number	Option Name	Option Type	Expiration
SCU-1800-SW-FWD	SCU-1800 Forward Sweep	perm	
SCU-1800-SW-REV-SWP	SCU-1800 Reverse Sweep Single User	perm	
SCU-1800-SW-REV-16PORT	SCU-1800 Enable 16 port Reverse Sweep	perm	
SCU-1800-SW-REV-SWP-MU	SCU-1800 Reverse Sweep Multi User	perm	

Deploy Option File

No file selected.

The screenshot shows a web browser at the URL https://10.0.0.156/#. The navigation menu includes Settings, Forward Sweep, and Single User Reverse Sweep. The 'Sweep Settings' section is active, displaying the following configuration:

- Forward Telemetry Frequency (MHz): 51
- Forward Telemetry Level (dBmV): 20
- Forward Sweep Level (dBmV): 20
- Reverse Telemetry Frequency (MHz): 10
- Automatically start sweep at power on:

A 'Submit Query' button is located at the bottom right of the settings panel.

About

Model Number
SCU-1800

Serial Number
0143469

SCU Receiver Calibration Date
4/3/2020

SCU Transmitter Calibration Date
2020-04-03 17:45:02

Login Settings

New Username

New Password

Confirm Password

Edit Channel Plan

Forward Sweep Select

Forward Sweep Plan Selector

Search:

Active	Name	Sweep Points	Channels
✓	node 123	0	0
	Sweep Home	0	0
	Node 123456798	0	116
	hhh	0	0
	Sudbury	0	107
	1poin2	0	101
	Brad	232	104
	Node 12345	0	102
	Node 1234567	0	116

Forward Sweep Edit

Plan Name:

Sweep Points List

Search:

Type	Frequency (MHz)	Span (MHz)	Level (dBmV)	Info
Channel	57.000	6	9.99	DIGITAL
Channel	63.000	6	10.80	DIGITAL
Channel	69.000	6	11.13	DIGITAL
Channel	75.250	1.536	6.93	DIGITAL
Channel	79.000	6	13.96	DIGITAL
Channel	85.000	7	13.90	DIGITAL
Channel	99.000	6	14.20	DIGITAL
Channel	104.250	1.536	7.93	DIGITAL
Channel	111.000	6	13.84	DIGITAL

Point Count: 116

Use level from channel plan build

Define Active Carriers in system which will be used as sweep points

Note: These carriers are not generated by the SCU but will be measured by the field instrument

Add Individual Active Channels to be used as sweep points

Note: These are active carriers that are to be used as measured sweep points by the field instrument but were not included in the channel plan import

Channel Type: Center Frequency (MHz): Channel Bandwidth: Level (dBmV):

Define carriers to be injected by the SCU-1800

Note: These are pulsed sweep points generated by the SCU-1800 in unoccupied spectrum

Add Multiple Sweep Injection Points

Note: This function inserts a sweep point at the start frequency given and will inject a sweep point every XX MHz defined by the Sweep Carrier Spacing up to and including the Stop Frequency if the Stop Frequency lands on the spacing boundary. This function utilizes a 500kHz guard band spacing and will only insert sweep points where there is at least 500kHz available from any previously defined carrier or sweep point.

Valid Frequency Range: 42 - 1210 MHz Valid Carrier Spacing Range: 1 - 8 MHz

Start Frequency (MHz): Stop Frequency (MHz): Sweep Carrier Spacing (MHz):

Add Individual Sweep Injection Points

Note: These are pulsed sweep points injected by the SCU-1800. Recommended to have 500kHz available spacing for each point.

Center Frequency (MHz):

New Channel Plan from ONX

VIavi Settings Forward Sweep Single User Reverse Sweep

Forward Sweep Select

New Forward Sweep Plan

Forward Sweep Plan Import

Forward Sweep Select

Forward Sweep Plan Selector

Search:

Active	Name	Sweep Points	Channels
✓	node 123	0	0
	Sweep Home	0	0
	Node 123456798	0	116
	hhh	0	0
	Sudbury	0	107
	1poin2	0	101
	Brad	232	104
	Node 12345	0	102
	Node 1234567	0	116

New Copy Edit Delete Import Export Activate Forward Plan

New Forward Sweep Plan

Step 1: Plan Name

Plan Name:

File Upload

File Upload

This PC > Desktop

Organize New folder

Name

- Node 8888.Ground Block.channel_plan.json
- Node 5555.Ground Block.channel_plan.json
- node 4444.Tap.channel_plan.json

File name: All Files (*.*)

New Forward Sweep Plan

Step 2: Import Channel Plan

Node 8888.Ground Block.channel_plan.json

New Channel Plan

Forward Sweep Select

Forward Sweep Plan Selector

Search:

Active	Name	Sweep Points	Channels
✓	node 123	0	0
	Sweep Home	0	0
	Node 123456798	0	116
	hhh	0	0
	Sudbury	0	107
	1pin2	0	101
	Brad	232	104
	Node 12345	0	102
	Node 1234567	0	116

New Forward Sweep Plan

Step 3: Add any additional sweep points.

Plan Name:

Sweep Points List

Search:

Type	Frequency (MHz)	Span (MHz)	Level (dBmV)	Info
Channel	57.000	6	9.99	DIGITAL
Channel	63.000	6	10.80	DIGITAL
Channel	69.000	6	11.13	DIGITAL
Channel	75.250	1.536	6.93	DIGITAL
Channel	79.000	6	13.96	DIGITAL
Channel	85.000	7	13.90	DIGITAL
Channel	99.000	6	14.20	DIGITAL
Channel	104.250	1.536	7.93	DIGITAL
Channel	111.000	6	13.84	DIGITAL

Point Count: 116

Use level from channel plan build

Define Active Carriers in system which will be used as sweep points

Note: These carriers are not generated by the SCU but will be measured by the field instrument

Add Individual Active Channels to be used as sweep points

Note: These are active carriers that are to be used as measured sweep points by the field instrument but were not included in the channel plan import.

Channel Type:
 Center Frequency (MHz):
 Channel Bandwidth:
 Level (dBmV):

Add Individual Sweep Injection Points

Note: These are pulsed sweep points injected by the SCU-1800. Recommended to have 500kHz available spacing for each point.

Center Frequency (MHz):

Define carriers to be injected by the SCU-1800

Note: These are pulsed sweep points generated by the SCU-1800 in unoccupied spectrum

Add Multiple Sweep Injection Points

Note: This function inserts a sweep point at the start frequency given and will inject a sweep point every XX MHz defined by the Sweep Carrier Spacing up to and including the Stop Frequency if the Stop Frequency lands on the spacing boundary. This function utilizes a 500kHz guard band spacing and will only insert sweep points where there is at least 500kHz available from any previously defined carrier or sweep point.

Valid Frequency Range: 42 - 1218 MHz Valid Carrier Spacing Range: 1 - 8 MHz

Start Frequency (MHz):
 Stop Frequency (MHz):
 Sweep Carrier Spacing (MHz):

Export and Import Channel Plan

VIavi Settings Forward Sweep Single User Reverse Sweep

Forward Sweep Select

New Forward Sweep Plan

Forward Sweep Plan Import

Forward Sweep Select

Forward Sweep Plan Selector

Search:

Active	Name	Sweep Points	Channels
✓	node 123	0	0
	Sweep Home	0	0
	Node 123456798	0	116
	hhh	0	0
	Sudbury	0	107
	1point	0	101
	Brad	232	104
	Node 12345	0	102
	Node 1234567	0	116

New Copy Edit Delete Import Export Activate Forward Plan

Save As

This PC > Documents

Search Documents

Organize New folder

Name	Date modified	Type
reflector.txt	5/14/2018 10:47 PM	Text Document
SDA Sweep Doc	10/30/2020 5:18 PM	File folder

File name: SweepPlan-3.json

Save as type: Text Documents (*.txt)

Encoding: UTF-8

Save Cancel

Forward Sweep Plan Import

Browse... SweepPlan-3.json

Import Forward Plan

Browse... SweepPlan-3.json

Import Forward Plan

Reverse Channel Plan

VIavi Settings Forward Sweep Single User Reverse Sweep

Reverse Sweep Select

New Reverse Sweep Plan

Reverse Sweep Plan Import

Reverse Sweep Active Meters

Reverse Sweep Select

Reverse Sweep Plan Selector

Search:

Active	Name	Sweep Points
✓	test	43
	Sudbury Rtn Mid-Split	177

Enable Reverse Sweep

New Reverse Sweep Plan

Step 1: Enter a name for the new reverse plan.

Plan Name:

Define carriers to be injected by the field meter

Note: These are pulsed sweep points generated by the field meter in unoccupied spectrum

Warning: SDA-5000 units may function incorrectly when the plan contains points below 5 MHz.

Add Multiple Sweep Injection Points

Note: This function inserts a sweep point at the start frequency given and will inject sweep points at the interval given.

Valid Frequency Range:

4 - 204 MHz

Start(MHz): Stop(MHz): Step Size(MHz):

New Reverse Sweep Plan

Step 2: Add any additional reverse sweep points.

Plan Name:

Sweep Points List

Search:

Type	Frequency (MHz)
Sweep Point	4.000
Sweep Point	5.000
Sweep Point	6.000
Sweep Point	7.000
Sweep Point	8.000
Sweep Point	9.000
Sweep Point	10.000
Sweep Point	11.000
Sweep Point	12.000
Sweep Point	13.000

Point Count: 42

Add Individual Sweep Injection Points

Note: These are pulsed sweep points injected by the field meter. Recommended to have 500kHz available spacing for each point.

Center(MHz):

Export and Import Reverse Channel Plan

VIavi Settings Forward Sweep Single User Reverse Sweep

Reverse Sweep Select

Reverse Sweep Plan Import

Reverse Sweep Active Meters

Reverse Sweep Select

Reverse Sweep Plan Selector

Search:

Active	Name	Sweep Points
✓	test	43
	Sudbury Rtn Mid-Split	177

Enable Reverse Sweep

Save As

< > > This PC > Documents

Organize New folder

Name	Date modified	Type
reflector.txt	5/14/2018 10:47 PM	Text D
SDA Sweep Doc	10/30/2020 5:18 PM	File fol

File name: SweepPlan-7.json

Save as type: Text Documents (*.txt)

Encoding: UTF-8

Reverse Sweep Plan Import

SweepPlan-7.json

Forward Sweep Overview

Ver 4.4.18



Forward Sweep with SDA 5500

- Sweep transmitter and headend monitor
- Constantly monitors video, audio, and digital carriers plus sweep insertion points
- Transmits any level variations to the Receiver on a telemetry carrier to update the reference
 - Keeps receiver up to date on headend levels

FORWARD SWEEP

Meter receives sweep pulses and reference levels transmitted from headend or hub site and displays difference levels (delta).

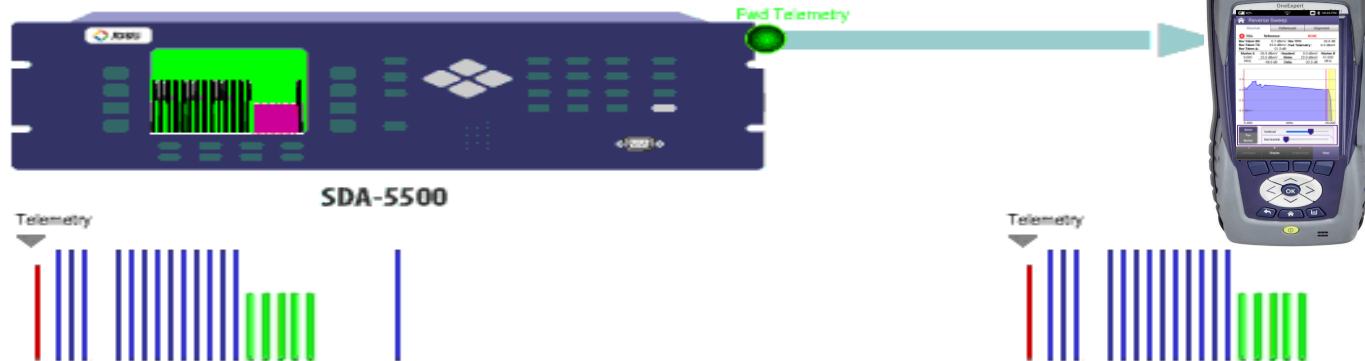

Forward Sweep with SCU-1800

- Sends sweep pulses telemetry and Channel level data to ONX via telemetry.
- Note: This channel level data is not constantly updated like the SDA

Forward Sweep

SCU-1800 gets channel plan from ONX and levels. Sweep insertion points are built here and transmitted out



Forward Sweep Test

- Forward Sweep allows techs to see frequency response of the carriers that are programmed in at the SDA 5500/SCU-1800
 - Helping techs find and correct plant issues
 - Saving a reference then allows delta comparisons to be made at various test points over time

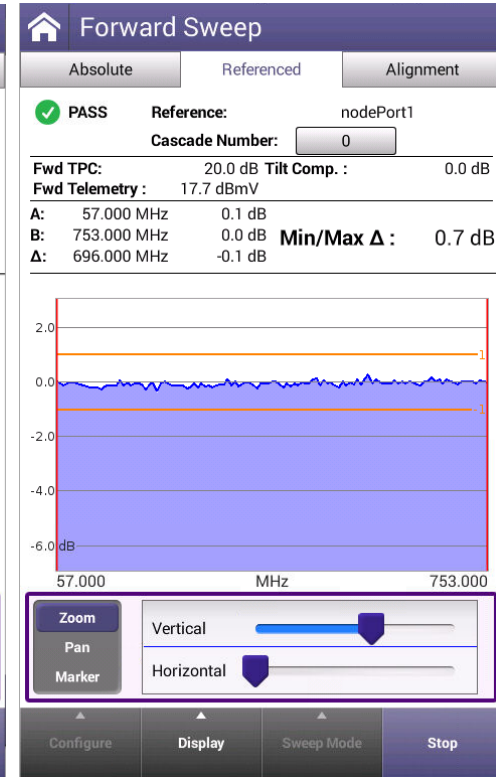

Absolute Tab – Showing All Signals Power Levels

Referenced Sweep Limit Threshold

Fwd Test point Compensation
Forward telemetry received Level

Marker A & B Information:
Absolute Level of the carrier

Graphical and Marker Adjustments
Zoom, Pan, Marker

Configure Menu
Display Menu

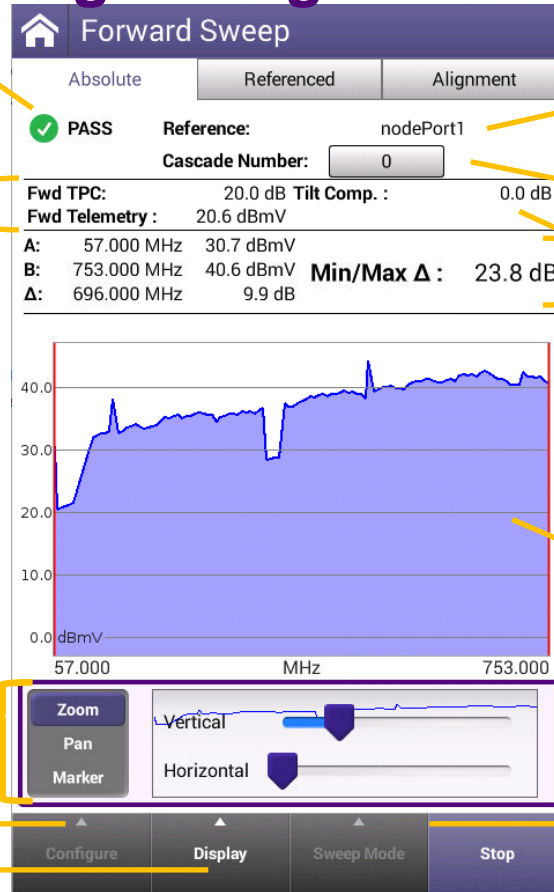

If a Reference is set, the Reference File Name is displayed (None – if no reference is set)

Place amplifier cascade
Tilt Comp

Min/Max delta

Absolute Sweep trace

Go to Forward or Reverse Sweep
Stop / Start the test

Saving a Reference

- Once ready, to save a reference first stop the test – Then press the Configure button and select “Save Test/Reference”
- Enter a Name for the reference and check the box “Set as Reference”
- Press the Save button - once saved, press the Back button to return to the test mode

Forward Sweep

Absolute Referenced Alignment

Reference: NONE

Cascade Number: 0

Fwd TPC: 20.0 dB Tilt Comp.: 0.0 dB

Fwd Telemetry: 17.7 dBmV

A: 57.000 MHz 30.5 dBmV

B: 753.000 MHz 40.2 dBmV

Δ: 696.000 MHz 9.7 dB

Min/Max Δ: 26.0 dB

Zoom Pan Marker

Vertical

Horizontal

Configure Display Sweep Mode Start

Forward Sweep

Absolute Referenced Alignment

Reference: NONE

Cascade Number: 0

Fwd TPC: 20.0 dB Tilt Comp.: 0.0 dB

Fwd Telemetry: 17.5 dBmV

A: 111.000 MHz 25.4 dBmV

B: 760.000 MHz 32.5 dBmV

Δ: 649.000 MHz 7.1 dB

Min/Max Δ: 25.9 dB

Sweep Config
Modify Sweep Configuration

Configure Test Point
+20.0 dB Fiber Node

Alignment Carrier Configuration
Add/Remove Carriers for Alignment

Choose Reference
Set reference sweep data

Save Test/Reference
Save current test to a Work Order

View Tests
View previous tests

Configure Display Sweep Mode Start

Save Forward Sweep Test

Save Test to Work Order

Work Order ID
Node123

Set as Reference

Cascade Number
0

Save was successful

Test Name
nodePort1

Set Name to Current Date Save

Forward Sweep

Absolute Referenced Alignment

PASS Reference: nodePort1

Cascade Number: 0

Fwd TPC: 20.0 dB Tilt Comp.: 0.0 dB

Fwd Telemetry: 17.7 dBmV

A: 57.000 MHz 0.1 dB

B: 753.000 MHz 0.0 dB

Δ: 696.000 MHz -0.1 dB

Min/Max Δ: 0.7 dB

Zoom Pan Marker

Vertical

Horizontal

Configure Display Sweep Mode Stop

ReferenceTab – Showing Relative RF Levels

Referenced Sweep Limit Threshold

Fwd Test point Compensation
Forward telemetry received Level

Marker A & B Information:
Absolute Level of the carrier

Graphical and Marker Adjustments
Zoom, Pan, Marker

Configure Menu
Display Menu

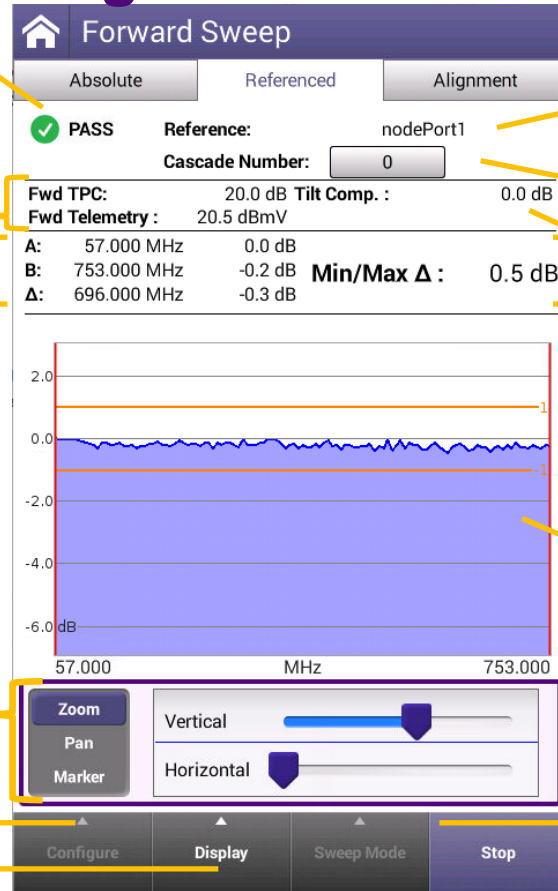

If a Reference is set, the Reference File Name is displayed (None – if no reference is set)

Place amplifier cascade Tilt Comp

Min/Max delta

Referenced Sweep trace

Go to Forward or Reverse Sweep
Stop / Start the test

Graphical and Marker Adjustments

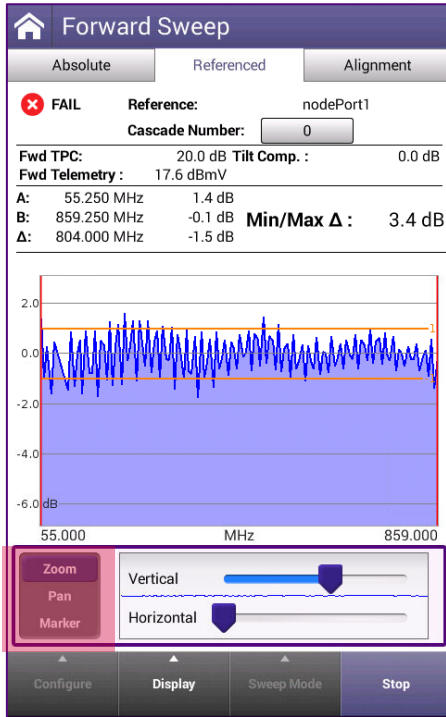

Zoom – Same as Pinch and Zoom on touch screen

- Vertical - Adjusts the dB/div
- Horizontal - Adjusts the frequency span

Pan – Adjust the bars to change the frequency span and slide the bar left or right to quickly change the displayed start and stop frequency based on the span

Marker – Select the “Marker A” or “Marker B” to move that marker left or right with the arrow keys

- CMTS values will adjust based on the frequency selected
- Markers can also be moved via touch screen

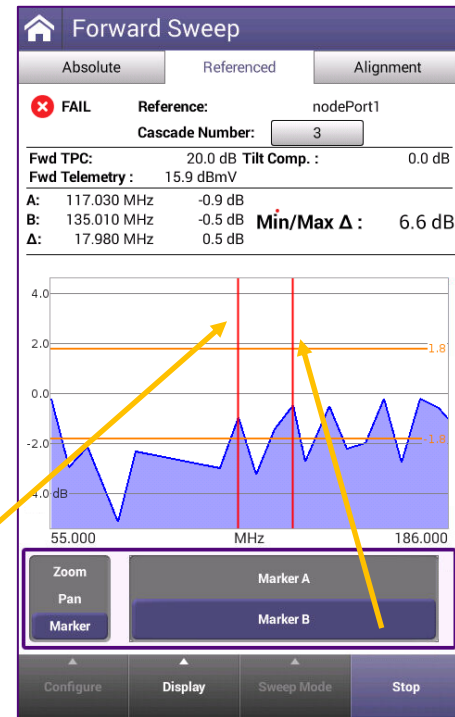
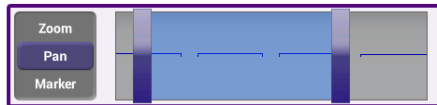



VIAVI Solutions

Forward Sweep

Forward Sweep Configure

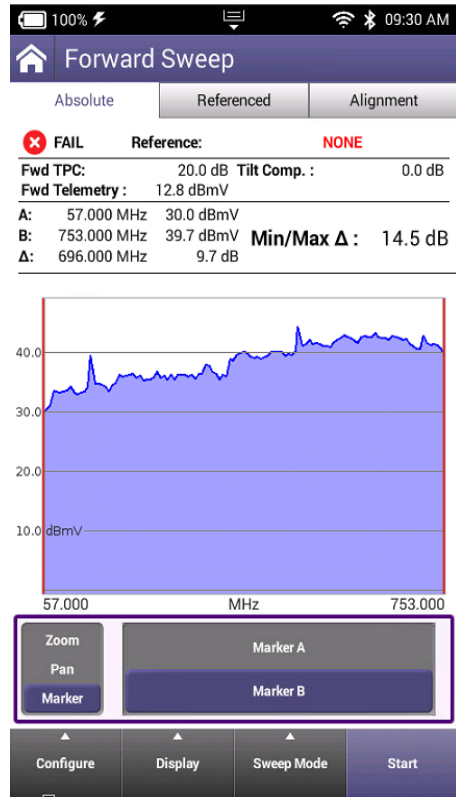

Sweep Config
Modify Sweep Configuration

Configure Test Point
+20.0 dB TPC1

Alignment Carrier Configuration
Add/Remove Carriers for Alignment

Choose Reference
Set reference sweep data

Save Test/Reference
Save current test to a Work Order

View Tests
View previous tests

Configure Sweep

Changes will restart test

SDA 5500 Telemetry Frequency
51.000 MHz

SDA 5510 Telemetry Frequency
52.000 MHz

Reverse Sweep User Mode
Single User

Enable Sweep Limit

Digital carrier bandwidth
6.000 MHz

Sweep Limit
4.0 dB

Select Reverse Sweep User Mode

Single User

Multi User

Forward Sweep Test Point

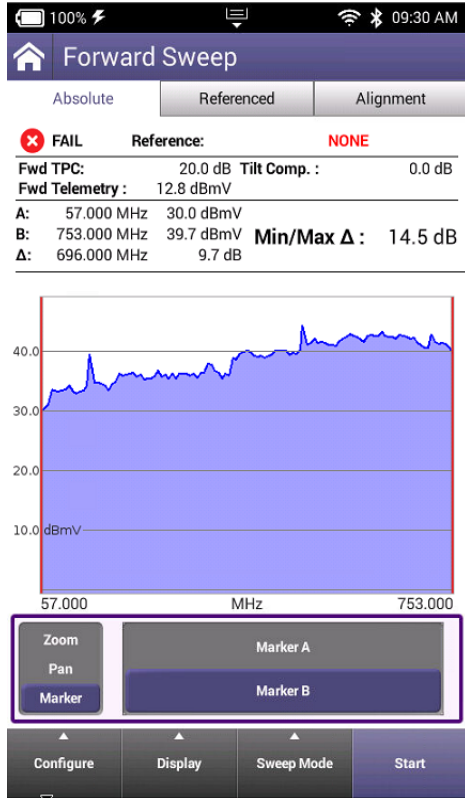

Sweep Config
Modify Sweep Configuration

Configure Test Point
+20.0 dB TPC1

Alignment Carrier Configuration
Add/Remove Carriers for Alignment

Choose Reference
Set reference sweep data

Save Test/Reference
Save current test to a Work Order

View Tests
View previous tests

Select Test Point Template

+0.0 dB TPC

+20.0 dB TPC

View | Delete | Copy | Done

New Custom Template

+20.0 dB TPC 1 1 - 40 chars

Save

Configure Test Point Template

+20.0 dB TPC 1

Forward Test Point Compensation
20.0 dB

Reverse Test Point Compensation
20 dB

Reverse Sweep Injection
8.0 dBmV

Reverse Telemetry Level
20.0 dBmV

Forward Tilt Compensation
0.0 dB

Forward Low Tilt Frequency
5.000 MHz

Forward High Tilt Frequency
800.000 MHz

Reverse Port Mode
Single Port

High Power Environment

Select Reverse Port Mode

Single Port

Dual Port

Forward Sweep Alignment

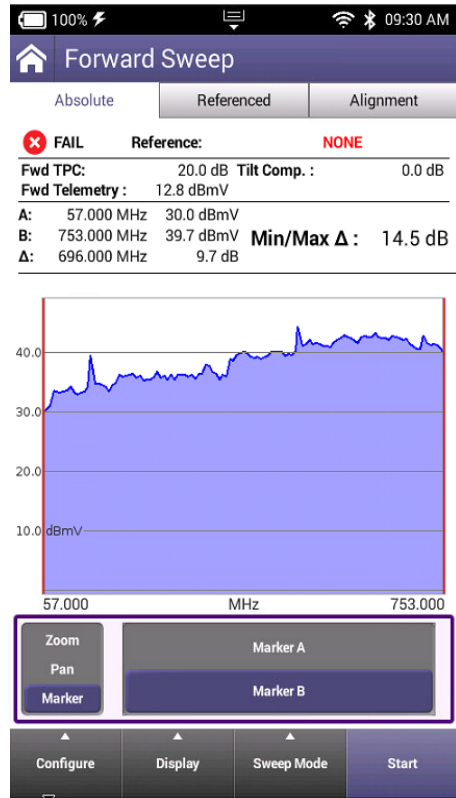

The 'Sweep Config' menu is shown, with the following options:

- Sweep Config**
Modify Sweep Configuration
- Configure Test Point**
+20.0 dB TPC 1
- Alignment Carrier Configuration**
Add/Remove Carriers for Alignment
- Choose Reference**
Set reference sweep data
- Save Test/Reference**
Save current test to a Work Order
- View Tests**
View previous tests

The 'Alignment Carrier Configuration' menu is shown, with the following options:

- Alignment Carrier Configuration**
Add/Remove Carriers for Alignment
- Choose Reference**
Set reference sweep data
- Save Test/Reference**
Save current test to a Work Order
- View Tests**
View previous tests

Below the menu, there are two input fields for carrier frequencies: '57.000 MHz' and '747.000 MHz'. At the bottom, there are buttons for 'Add Carrier', 'Remove Carrier', and 'Load Defaults'.

The 'Add Carrier' dialog box is shown, with the 'Carrier Frequency (MHz)' set to '747.000'. Below it, the 'Frequency (MHz)' dialog box is shown, with the frequency set to '747.000' and a range of '48.000 - 1002.000'. An 'OK' button is visible at the bottom of the 'Frequency (MHz)' dialog.

Forward Sweep Point Clear Reference

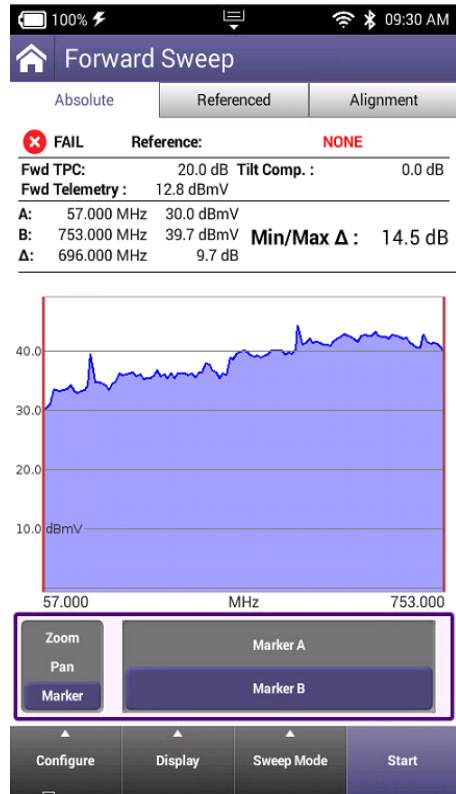

Sweep Config
Modify Sweep Configuration

Configure Test Point
+20.0 dB TPC 1

Alignment Carrier Configuration
Add/Remove Carriers for Alignment

Choose Reference
Set reference sweep data

Save Test/Reference
Save current test to a Work Order

View Tests
View previous tests

Forward Sweep Reference

Work Order | Recent References

Forward Reference **NONE**

From Work Order:

Tests for Current Work Order:

Work Order ID

Node 8888

Clear Reference | Set Reference

Select Work Order

New Work Order ...

- Node 8888
- Node 5555
- node 4444
- Node 123
- Work Order - 10-22-39 10-25-2020

Forward Sweep Point Save Reference

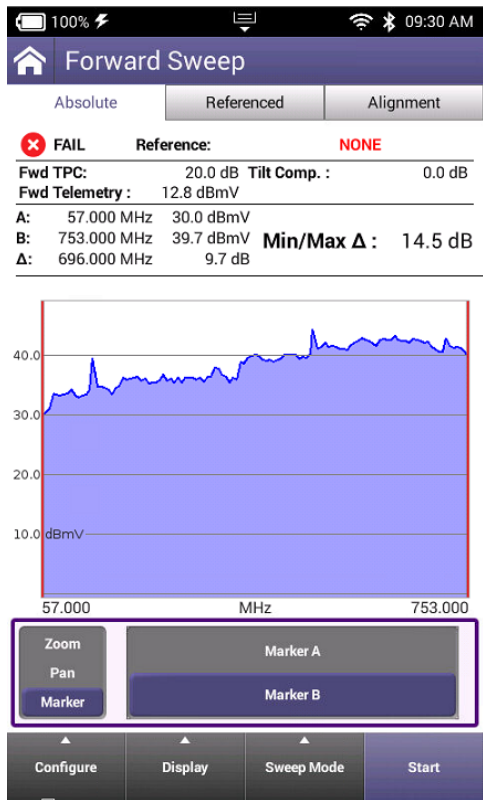

The screenshot shows the 'Sweep Config' menu. The options are:

- Sweep Config**
Modify Sweep Configuration
- Configure Test Point**
+20.0 dB TPC 1
- Alignment Carrier Configuration**
Add/Remove Carriers for Alignment
- Choose Reference**
Set reference sweep data
- Save Test/Reference** (highlighted with a purple box)
Save current test to a Work Order
- View Tests**
View previous tests

The screenshot shows the 'Save Forward Sweep Test' dialog box. The options are:

- Save Test to Work Order**
- Test Name
Node 123 Port 2
- Work Order ID
Node 8888
- Set as Reference

At the bottom, there are three buttons: 'Set Name to Current Date', 'Save', and 'Save'.

Forward Sweep Review Test



Sweep Config
Modify Sweep Configuration

Configure Test Point
+20.0 dB TPC 1

Alignment Carrier Configuration
Add/Remove Carriers for Alignment

Choose Reference
Set reference sweep data

Save Test/Reference
Save current test to a Work Order

View Tests
View previous tests

Detailed description: This is a menu for 'Sweep Config' with options to modify configuration, configure test points, alignment carriers, choose references, save tests, and view previous tests. The 'View Tests' option is highlighted with a red box.

Forward Sweep Tests

Tests for Current Work Order:

Node 123 Port 2

Work Order ID

Node 8888

View Results

Detailed description: This screen shows the results of the 'Forward Sweep Tests' for 'Node 123 Port 2'. It displays the 'Work Order ID' as 'Node 8888' and includes a 'View Results' button at the bottom right.

Forward Sweep Test Markers

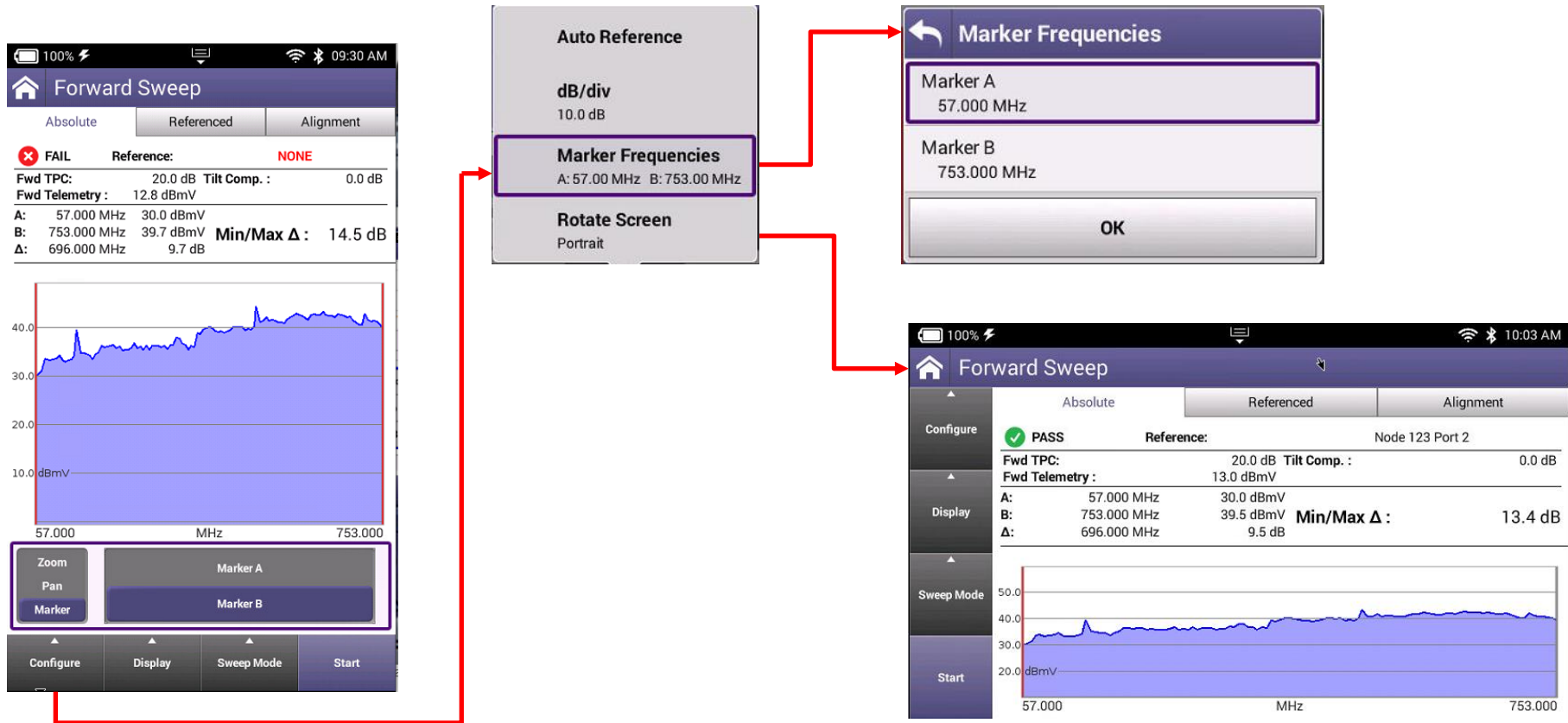

Forward Sweep Screens

Absolute "Raw"

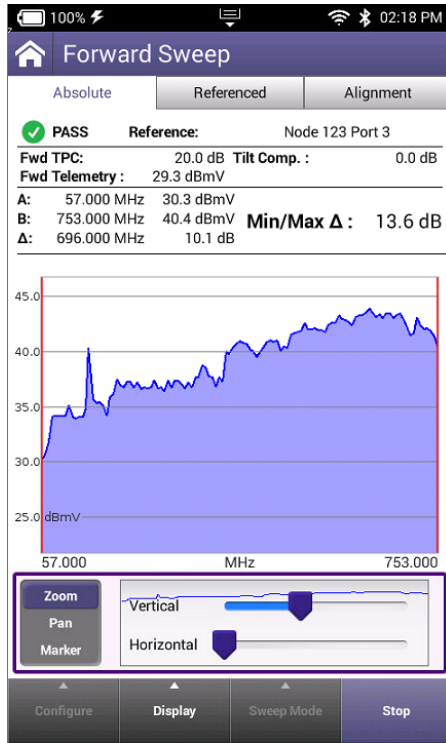

Referenced

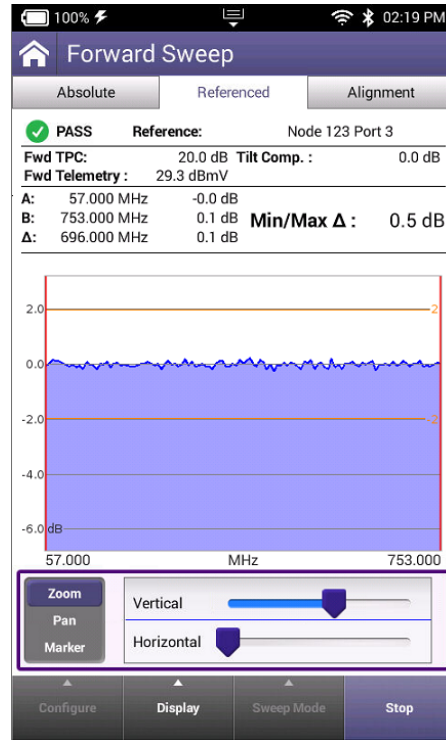

Alignment

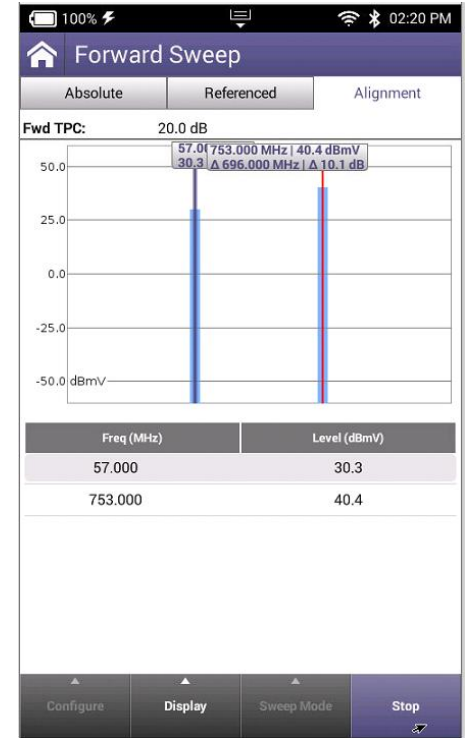

Reverse Sweep Overview

Ver 4.4.18

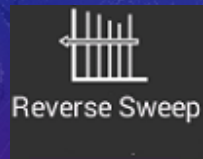

Return Sweep Principle

Sweep transmitter

Sends forward Telemetry carrier that contains the return sweep channel plan and a return telemetry frequency to the field units

The field unit captures the telemetry and transmits the return telemetry and sweep points to the headend device SDA5500/SCU-1800

The headend device measures the levels and returns the information to the field unit for display.

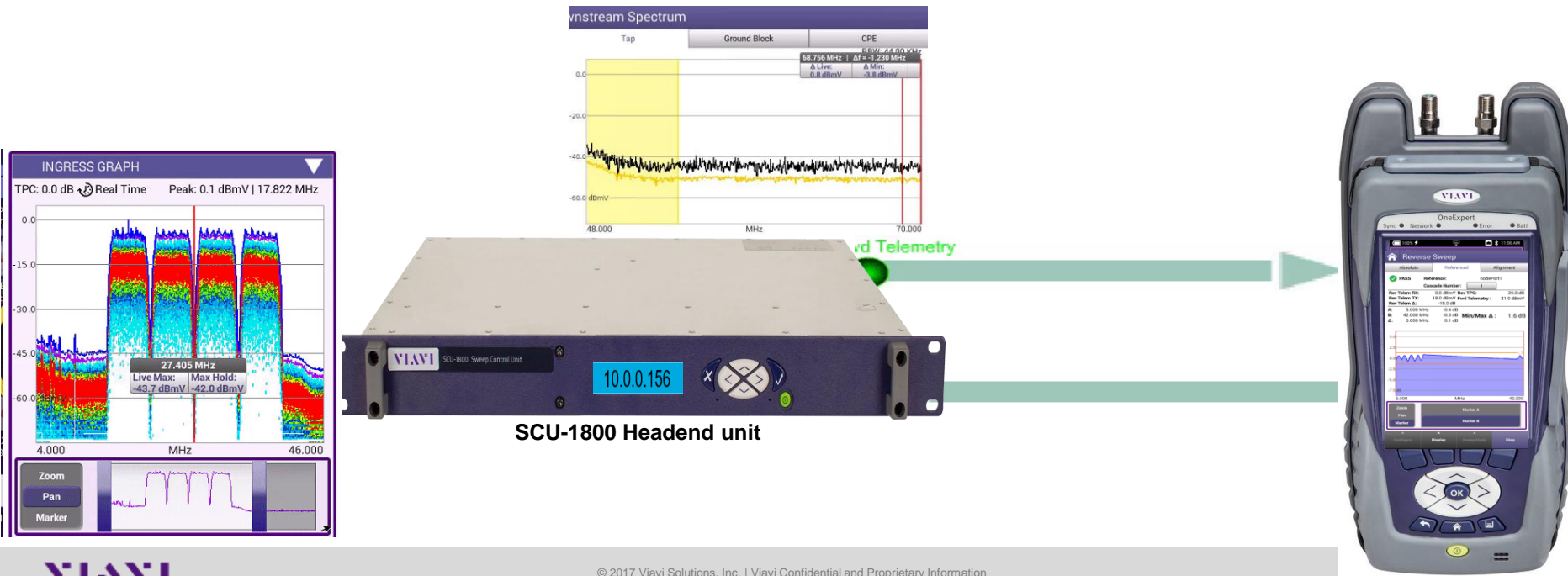

Introducing Optional Reverse Sweepless Sweep mode

- The Absolute tab shows the live estimated response at the Headend
 - In Channel Frequency Response is adapted from upstream pre-equalization established between the ONX at the test location and the SDA/SCU .The Referenced tab shows any amplitude deltas over frequency from the original test location to the current test location

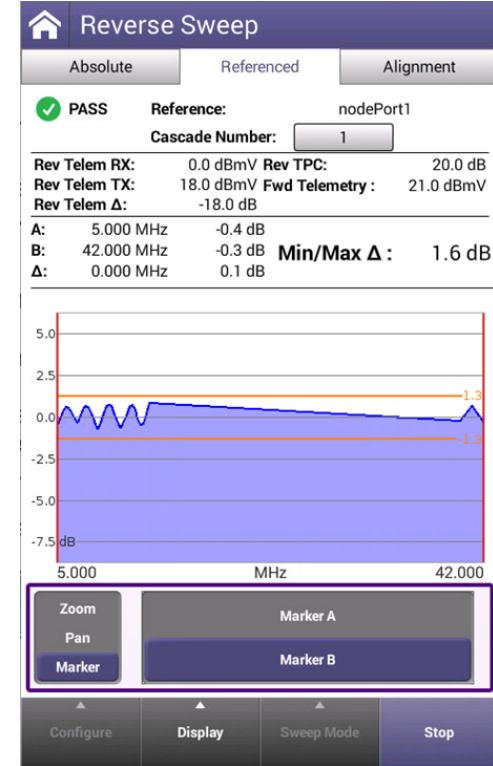
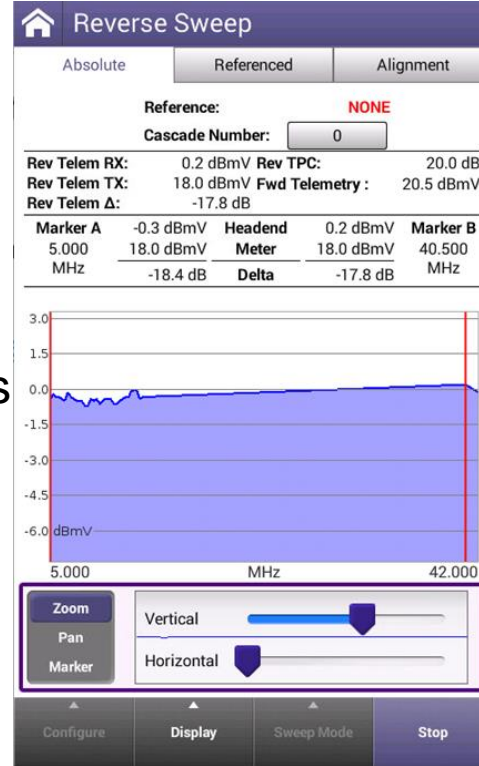

Absolute Tab – Showing Adjusted Headend Response

Referenced Sweep Limit Threshold

Telemetry level at the transmitter

Telemetry level transmitted from ONX

Delta level

Marker A & B Information:

Frequency, adjusted level at the SDA/SCU, the meter's adjusted transmit level, the delta (loss / gain) between meter and SDA/SDU

Graphical and Marker Adjustments
Zoom, Pan, Marker

Configure Menu
Display Menu

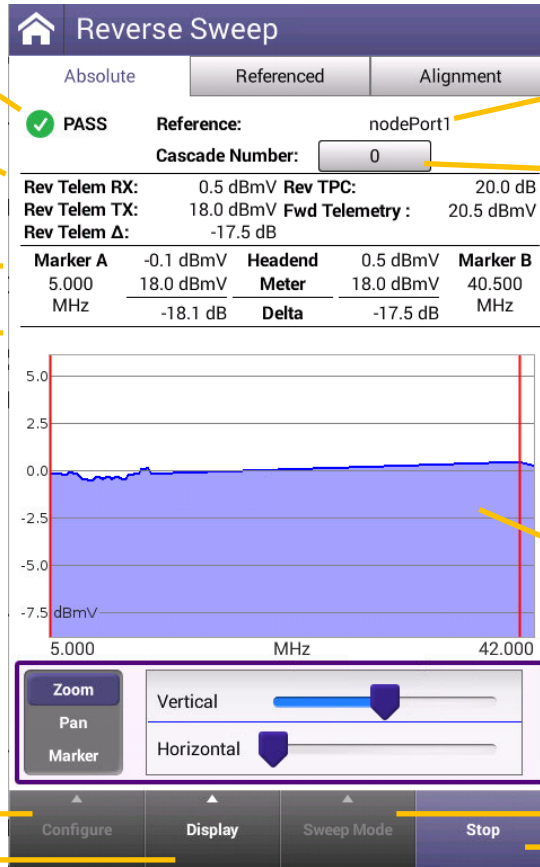

If a Reference is set, the Reference File Name is displayed (None – if no reference is set)

Place amplifier cascade

Reverse Test Point Compensation Value

Forward Received Telemetry Level

The absolute trace is the adjusted frequency response expected at the connected SDA/SCU located at the headend

Go to Forward or Reverse Sweep
Stop / Start the test

Saving a Reference

- Once ready, to save a reference first stop the test – Then press the Configure button and select “Save Test/Reference”
- Enter a Name for the reference and check the box “Set as Reference”
- Press the Save button - once saved, press the Back button to return to the test mode

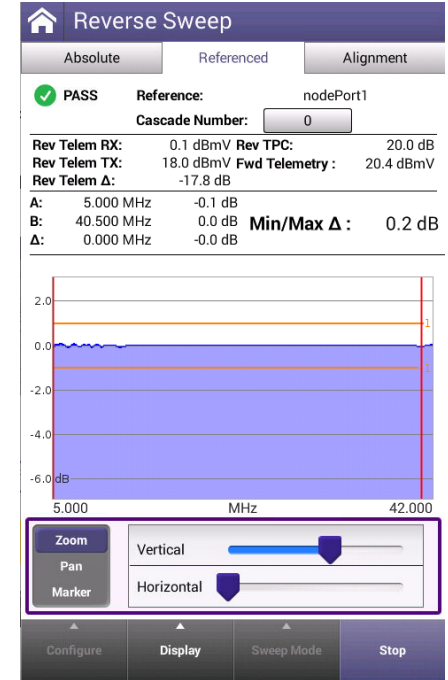
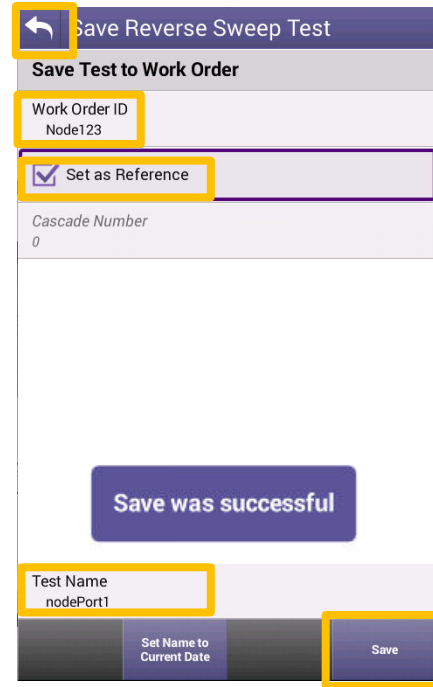
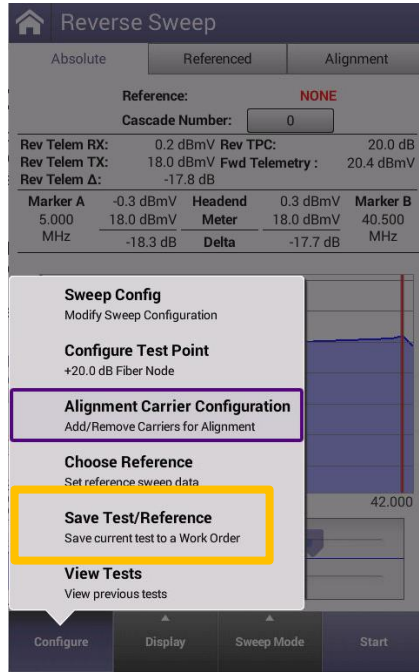
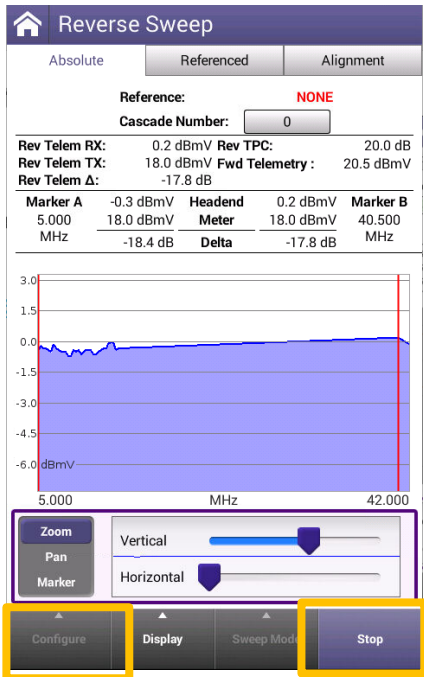

Referenced Tab – Displays frequency response deltas

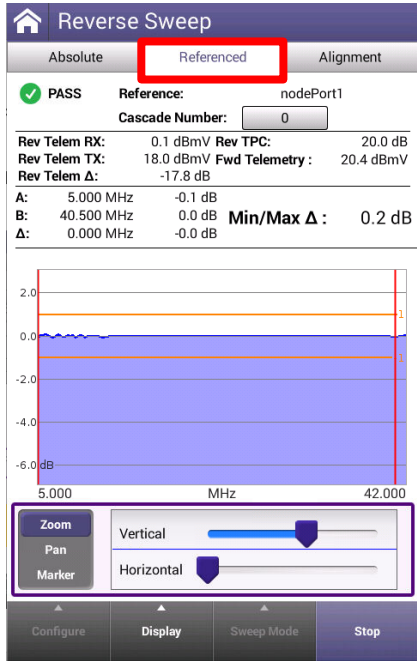

Just after saving a reference the reference trace will be very close to zero and may adjust slightly over time

As new test points are measured, and levels differ over frequency relative to the original test point, the Referenced sweep trace will update to reflect those deltas

Negative response shows where signal loss / attenuation occurs, while positive response shows where signal gain / amplification occurs relative to the reference test point

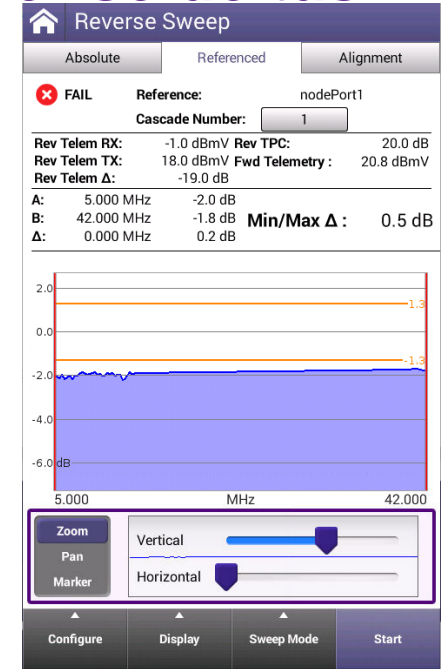
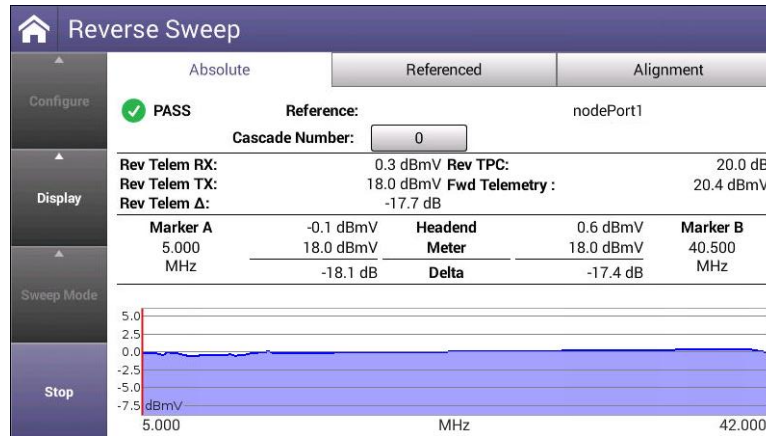

About 2.5 dB additional attenuation in this portion of the network than when compared to the originally referenced sweep response trace – Indicating there is 2.5dB of relative loss at this test location and should be corrected

Referenced Tab – Continued

Referenced Sweep Limit Threshold

Telemetry level at the transmitter

Telemetry level transmitted from ONX
delta level

Marker A & B Information:
Frequency, the delta
(loss / gain) between the originally referenced
trace and the currently measured trace
Delta – difference in marker frequency and
marker response difference

Configure Menu
Display Menu

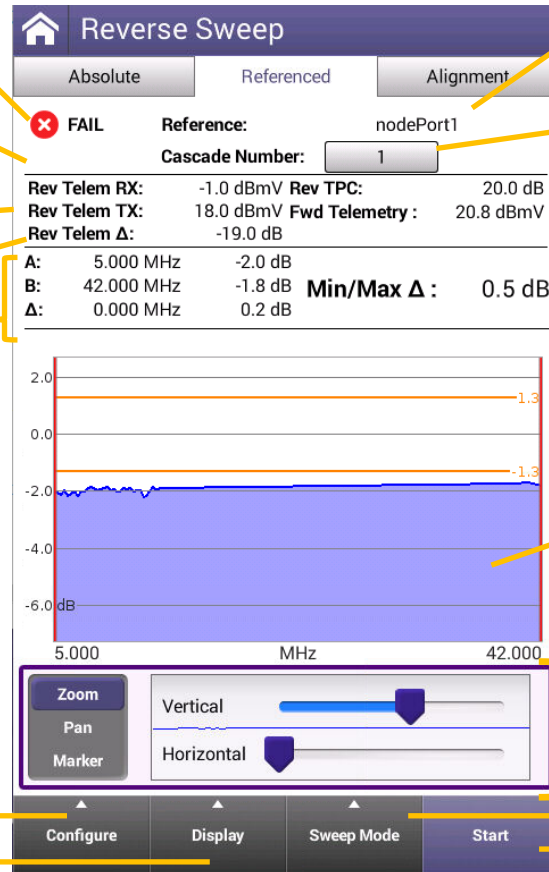

The Reference File Name
(None – if no reference is set)

Place amplifier cascade

Reverse Test Point Compensation
Value and Forward Telemetry
received level

Minimum or Maximum delta in the
trace between the markers

The referenced trace displays
frequency response deltas between
the original trace and the currently
measured trace

Graphical and Marker Adjustments
Zoom, Pan, Marker

Go to Forward or Reverse Sweep
Stop / Start the test

Graphical and Marker Adjustments

Zoom – Same as Pinch and Zoom on touch screen

- Vertical - Adjusts the dB/div
- Horizontal - Adjusts the frequency span

Pan – Adjust the bars to change the frequency span and slide the bar left or right to quickly change the displayed start and stop frequency based on the span

Marker – Select the “Marker A” or “Marker B” to move that marker left or right with the arrow keys

- CMTS values will adjust based on the frequency selected
- Markers can also be moved via touch screen

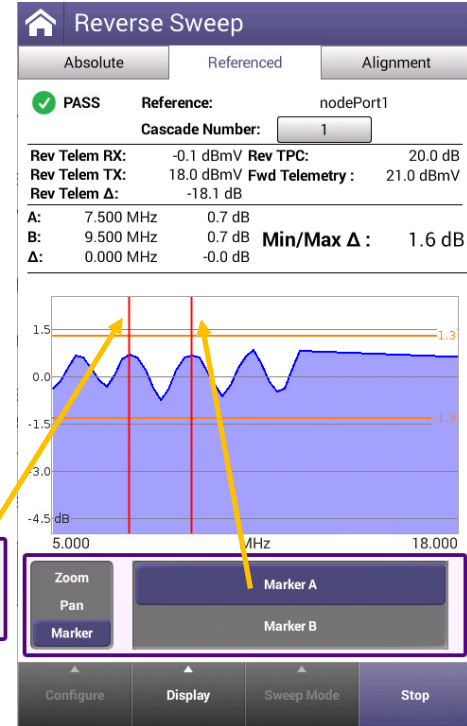
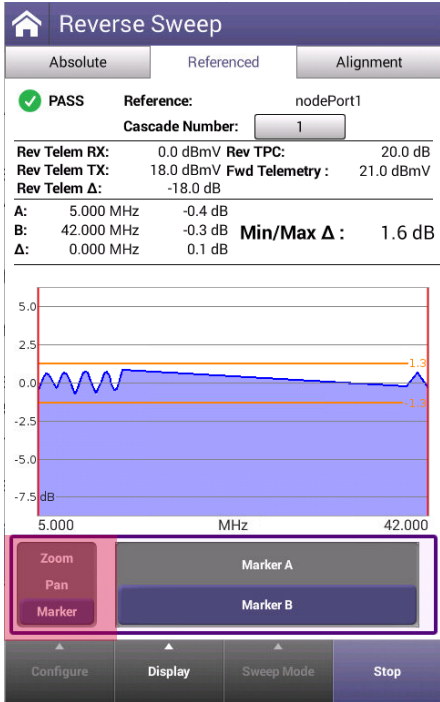

Return Sweep

Reverse Sweep Configure

Reverse Sweep

Absolute Referenced Alignment

PASS Reference: Node 123 Port 3

Rev Telem RX:	1.4 dBmV	Rev TPC:	20.0 dB
Rev Telem TX:	17.0 dBmV	Fwd Telemetry :	30.1 dBmV
Rev Telem Δ:	-15.6 dB		

Marker A	0.5 dBmV	Headend	1.9 dBmV	Marker B
4.000	17.0 dBmV	Meter	17.0 dBmV	41.500
MHz	-16.5 dB	Delta	-15.1 dB	MHz

5.0
0.0
-5.0
-10.0
-15.0 dBmV

4.000 MHz 45.000

Zoom
Pan
Marker

Vertical
Horizontal

Configure Display Sweep Mode Start

- Forward Sweep
- Reverse Sweep
- Reverse Sweepless Sweep

Configure Sweep

Changes will restart test

SDA 5500 Telemetry Frequency
51.000 MHz

SDA 5510 Telemetry Frequency
52.000 MHz

Reverse Sweep User Mode
Single User

Enable Sweep Limit

Digital carrier bandwidth
6.000 MHz

Sweep Limit
4.0 dB

Select Reverse Sweep User Mode

Single User

Multi User

Select Digital carrier bandwidth

6.000 MHz

8.000 MHz

Reverse Sweep Configure Test Point

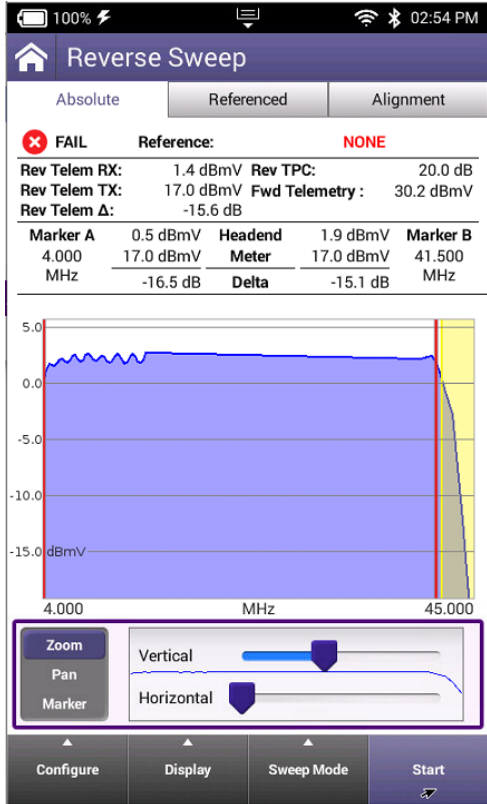

Sweep Config
Modify Sweep Configuration

Configure Test Point
+20.0 dB TPC1

Alignment Carrier Configuration
Add/Remove Carriers for Alignment

Choose Reference
Set reference sweep data

Save Test/Reference
Save current test to a Work Order

View Tests
View previous tests

Select Test Point Template

+0.0 dB TPC

+20.0 dB TPC

View | Delete | Copy | Done

New Custom Template

+20.0 dB TPC 1 1 - 40 chars

Save

Configure Test Point Template

+20.0 dB TPC 1

Forward Test Point Compensation
20.0 dB

Reverse Test Point Compensation
20 dB

Reverse Sweep Injection
8.0 dBmV

Reverse Telemetry Level
20.0 dBmV

Forward Tilt Compensation
0.0 dB

Forward Low Tilt Frequency
5.000 MHz

Forward High Tilt Frequency
800.000 MHz

Reverse Port Mode
Single Port

High Power Environment

Select Reverse Port Mode

Single Port

Dual Port

Reverse Sweep Configure Test Point Injection

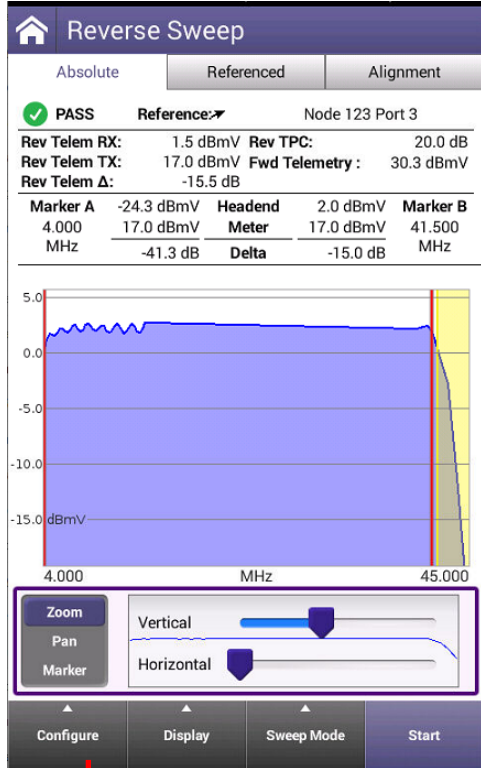

Sweep Config
Modify Sweep Configuration

Configure Test Point
+20.0 dB TPC1

Alignment Carrier Configuration
Add/Remove Carriers for Alignment

Choose Reference
Set reference sweep data

Save Test/Reference
Save current test to a Work Order

View Tests
View previous tests

Select Test Point Template

- +0.0 dB TPC
- +20.0 dB TPC
- +20.0 dB TPC 1

View / Edit Delete Copy Done

New Custom Template

+20.0 dB TPC 1 1 - 40 chars

Save

Configure Test Point Template

Forward Test Point Compensation: 20.0 dB

Reverse Test Point Compensation: 20 dB

Reverse Sweep Injection: 17.0 dBmV

Reverse Telemetry Level: 17.0 dBmV

Forward Tilt Compensation: 0.0 dB

Forward Low Tilt Frequency: 54.000 MHz

Forward High Tilt Frequency: 860.000 MHz

Reverse Port Mode: Single Port

High Power Environment

The sum of Reverse Test Point Compensation and Reverse Sweep Injection must be less than or equal to 53.0 dBmV for valid results.

Reverse Sweep Injection

17.0 dBmV

OK

Reverse Telemetry Level

17.0 dBmV

OK

Select Reverse Port Mode

Single Port

Dual Port

Reverse Sweep Alignment

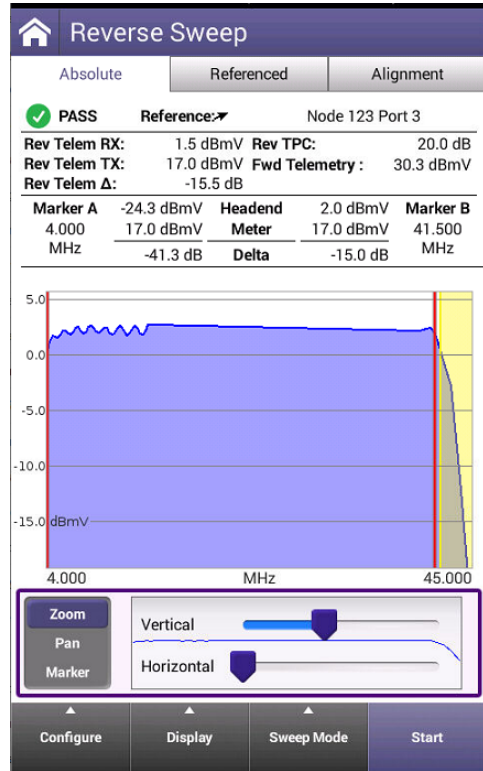

Sweep Config
Modify Sweep Configuration

Configure Test Point
+20.0 dB TPC 1

Alignment Carrier Configuration
Add/Remove Carriers for Alignment

Choose Reference
Set reference sweep data

Save Test/Reference
Save current test to a Work Order

View Tests
View previous tests

Alignment Carrier Configuration

Forward Sweep | Reverse Sweep

- 5.000 MHz
- 14.000 MHz
- 41.500 MHz

Add Carrier | Remove Carrier | Load Defaults

Add Carrier
Carrier Frequency (MHz)
41.500

Frequency (MHz)
41.500 | 4.000 - 204.000
OK

Reverse Sweep Clear Or Choose Reference

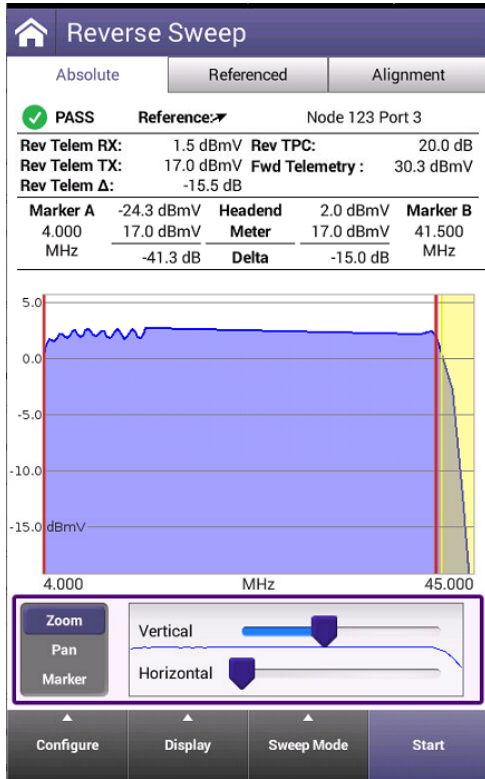

Sweep Config
Modify Sweep Configuration

Configure Test Point
+20.0 dB TPC 1

Alignment Carrier Configuration
Add/Remove Carriers for Alignment

Choose Reference
Set reference sweep data

Save Test/Reference
Save current test to a Work Order

View Tests
View previous tests

Reverse Sweep Reference

Work Order | Recent References

Reverse Reference: Node 123 Port 3
From Work Order: 5678

Tests for Current Work Order:

Node 123 Port 3

Work Order ID: 5678

Clear Reference | Set Reference

Reverse Sweep Reference

Work Order | Recent References

Reverse Reference: Node 123 Port 3
From Work Order: 5678

Recently Used References:

- Node 123 Port 3
5678
- Node 123 Port 2
Node 123
- node 123 port3
home8542
- node 123 port3
node 12345
- node 123 port1r
node 12345
- node 123 rev
node 123
- node333p1
node333
- node23noderet
node23

Clear Reference | Set Reference

Reverse Sweep Save Reference

Reverse Sweep

Absolute | Referenced | Alignment

PASS Reference: Node 123 Port 3

Rev Telem RX:	1.5 dBmV	Rev TPC:	20.0 dB
Rev Telem TX:	17.0 dBmV	Fwd Telemetry:	30.3 dBmV
Rev Telem Δ:	-15.5 dB		

Marker A	-24.3 dBmV	Headend	2.0 dBmV	Marker B
4.000	17.0 dBmV	Meter	17.0 dBmV	41.500
MHz	-41.3 dB	Delta	-15.0 dB	MHz

Graph showing dBmV vs MHz (4.000 to 45.000). The graph displays a blue signal line with a shaded area below it, indicating a sweep test. A vertical red line is positioned at 41.500 MHz, corresponding to Marker B.

Zoom | Pan | Marker

Vertical | Horizontal

Configure | Display | Sweep Mode | Start

Sweep Config
Modify Sweep Configuration

Configure Test Point
+20.0 dB TPC 1

Alignment Carrier Configuration
Add/Remove Carriers for Alignment

Choose Reference
Set reference sweep data

Save Test/Reference
Save current test to a Work Order

View Tests
View previous tests

Save Reverse Sweep Test

Save Test to Work Order

Test Name
Node 123 Port 3

Work Order ID
5678

Set as Reference

Reverse Sweep Tests

Tests for Current Work Order:

Node 123 Port 3

Reverse Sweep Display Settings

Reverse Sweep

Absolute Referenced Alignment

PASS Reference: Node 123 Port 3

Rev Telem RX: 1.5 dBmV Rev TPC: 20.0 dB
 Rev Telem TX: 17.0 dBmV Fwd Telemetry : 30.3 dBmV
 Rev Telem Δ: -15.5 dB

A: 4.000 MHz 0.0 dB
 B: 41.500 MHz 0.1 dB **Min/Max Δ :** 0.1 dB
 Δ: 37.500 MHz 0.1 dB

4.000 MHz 45.000

Zoom Vertical Horizontal

Pan

Marker

Configure Display Sweep Mode Start

Auto Reference

dB/div
2.0 dB

Marker Frequencies
A: 4.00 MHz B: 41.50 MHz

Rotate Screen
Portrait

dB/div

1.0 dB

2.0 dB

5.0 dB

10.0 dB

20.0 dB

Marker Frequencies

Marker A
4.000 MHz

Marker B
41.500 MHz

OK

Reverse Sweep

Absolute Referenced Alignment

PASS Reference: Node 123 Port 3

Rev Telem RX: 1.5 dBmV Rev TPC: 20.0 dB
 Rev Telem TX: 17.0 dBmV Fwd Telemetry : 30.3 dBmV
 Rev Telem Δ: -15.5 dB

A: 4.000 MHz 0.0 dB
 B: 41.500 MHz 0.1 dB **Min/Max Δ :** 0.1 dB
 Δ: 37.500 MHz 0.1 dB

4.000 MHz 45.000

Sweep Mode

Stop

Reverse Sweep Screens

Absolute "Raw"

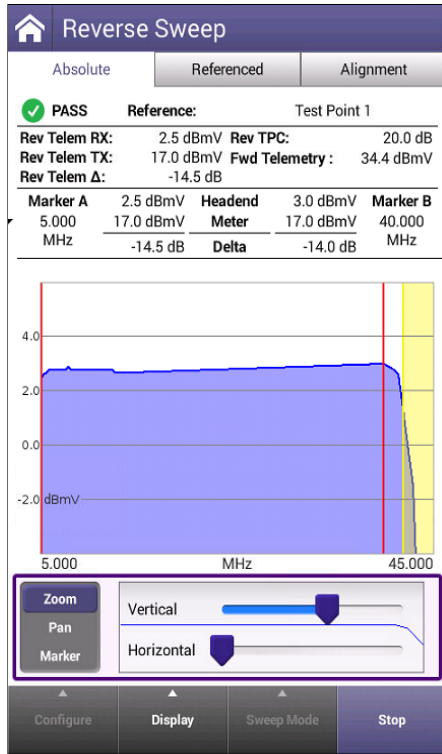

Referenced

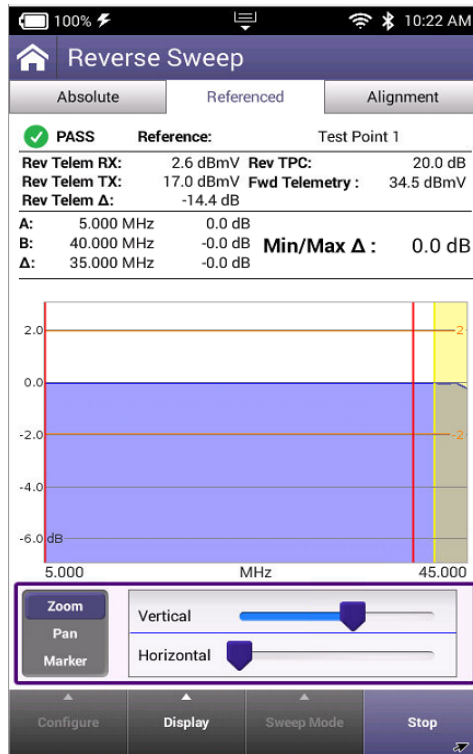

Alignment

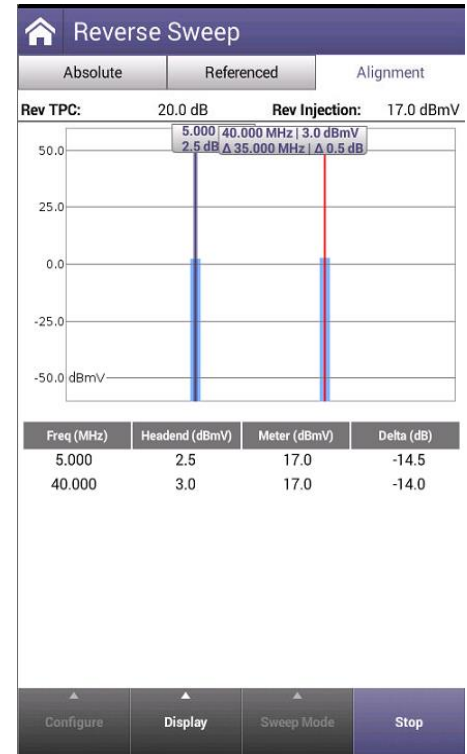

Reverse Sweepless Sweep Overview

Viavi ONX-CATV Optional Feature



Reverse
Sweepless

Upstream Sweepless Sweep

- Uses the CMTS/Modem technology for Upstream Sweepless Sweep
- Non-intrusive / Passive Sweep Solution
 - No effect on any system carriers
- No rack space needed for Upstream Sweepless Sweep
 - No Powering
 - No Cooling
 - No Operational Failure point (Transmitters)
- As Upstream carriers are added, Sweep coverage is simultaneously increased
 - As carriers are added, additional sweep points are also added to the solution
 - Therefore, increasing the sweep resolution throughout the entire frequency band
 - Wide-band carriers (6.4MHz / OFDMA) carriers make active sweep insertion more complex
- No need to swap out transmitters as technology changes / evolves
- R-Phy compatible, sweep passively today in your new deployments

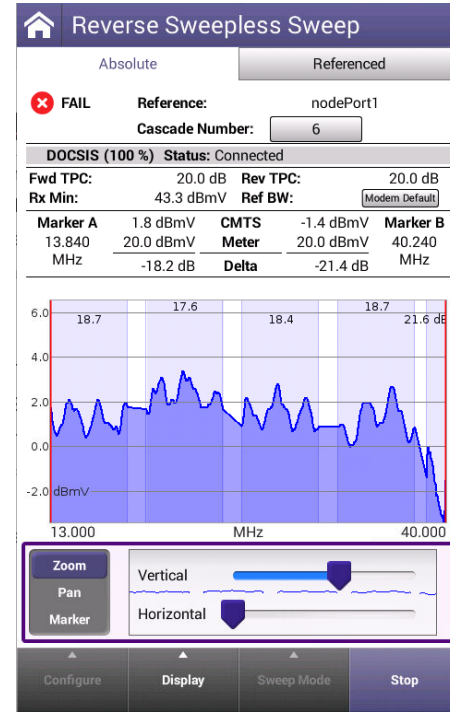

Introducing Optional Reverse Sweepless Sweep mode

- Reverse Sweepless Sweep allows techs to see frequency response issues in the active return frequencies
 - Helping techs find and correct plant issues similar to active reverse sweep
- Reverse Sweepless Sweep graphs combine active upstream transmitted DOCSIS channels with CMTS response information
- Saving a reference then allows delta comparisons to be made at various test points over time

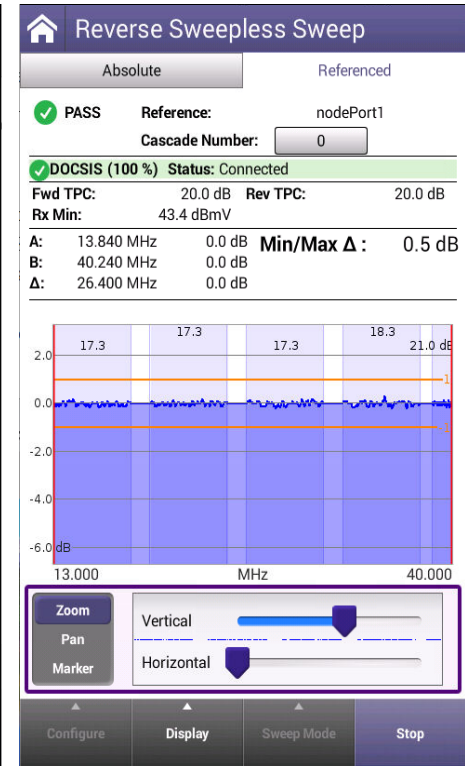

Introducing Optional Reverse Sweepless Sweep mode

- The Absolute tab shows the live estimated response at the Headend
 - In Channel Frequency Response is adapted from upstream pre-equalization established between the ONX at the test location and the CMTS / RPHY device location
- The Referenced tab shows any amplitude deltas over frequency from the original test location to the current test location

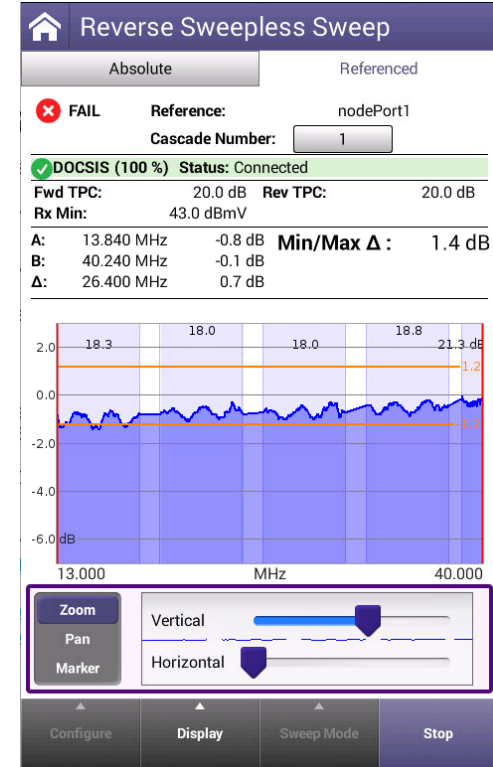

Absolute Tab – Showing Adjusted Headend Response

Reverse Sweepless Sweep

Absolute Referenced

PASS Reference: nodePort1
Cascade Number: 0

DOCSIS (100 %) Status: Connected

Fwd TPC:	20.0 dB	Rev TPC:	20.0 dB
Rx Min:	43.2 dBmV	Ref BW:	Modem Default

Marker A	2.3 dBmV	CMTS	-1.5 dBmV	Marker B
13.840 MHz	20.0 dBmV	Meter	20.0 dBmV	40.240 MHz
	-17.7 dB	Delta	-21.5 dB	

Graph: dBr/V vs MHz (13.000 to 40.000)

Graph Markers:

17.5	17.5	17.5	18.3	21.0 dB
------	------	------	------	---------

Control Panel:

- Zoom
- Pan
- Marker
- Vertical slider
- Horizontal slider

Bottom Buttons: Configure, Display, Sweep Mode, Stop

Referenced Sweep Limit Threshold

DOCSIS Communication Status

Forward Test Point Compensation Value

Minimum Received Downstream Channel level

Marker A & B Information:
Frequency, adjusted level at the CMTS, the meter's adjusted transmit level, the delta (loss / gain) between meter and CMTS

Graphical and Marker Adjustments
Zoom, Pan, Marker

Configure Menu
Display Menu

If a Reference is set, the Reference File Name is displayed (None – if no reference is set)

Place amplifier cascade

Reverse Test Point Compensation Value

Reference Bandwidth – More details below

The absolute trace is the adjusted frequency response expected at the headend or Remote PHY Node

Go to Forward or Reverse Sweep
Stop / Start the test

Saving a Reference

- Once ready, to save a reference first stop the test – Then press the Configure button and select “Save Test/Reference”
- Enter a Name for the reference and check the box “Set as Reference”
- Press the Save button - once saved, press the Back button to return to the test mode

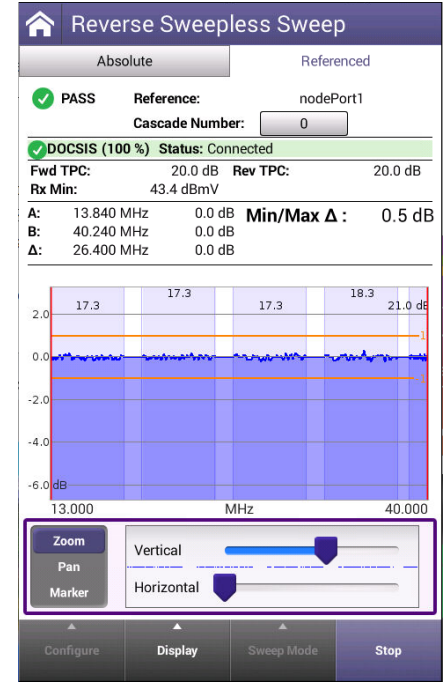
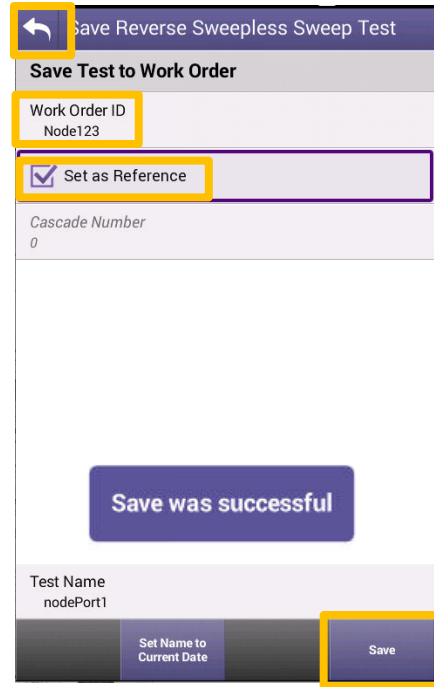
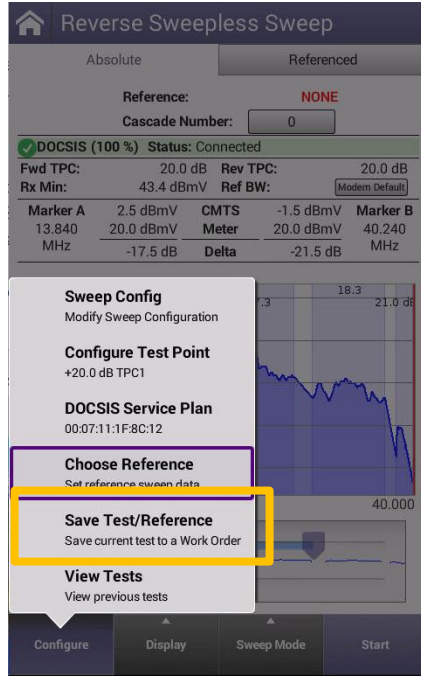

Referenced Tab – Displays frequency response deltas

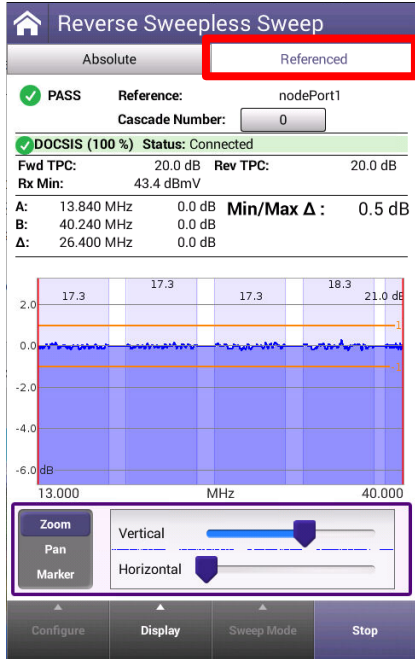

Just after saving a reference the reference trace will be very close to zero and may adjust slightly over time

As new test points are measured, and levels differ over frequency relative to the original test point, the Referenced sweep trace will update to reflect those deltas

Negative response shows where signal loss / attenuation occurs, while positive response shows where signal gain / amplification occurs relative to the reference test point

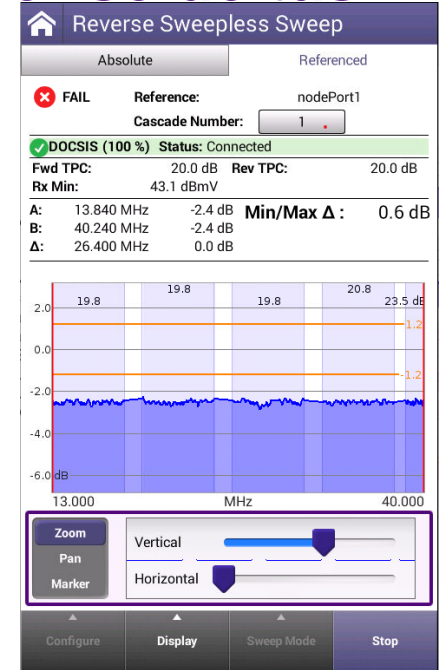
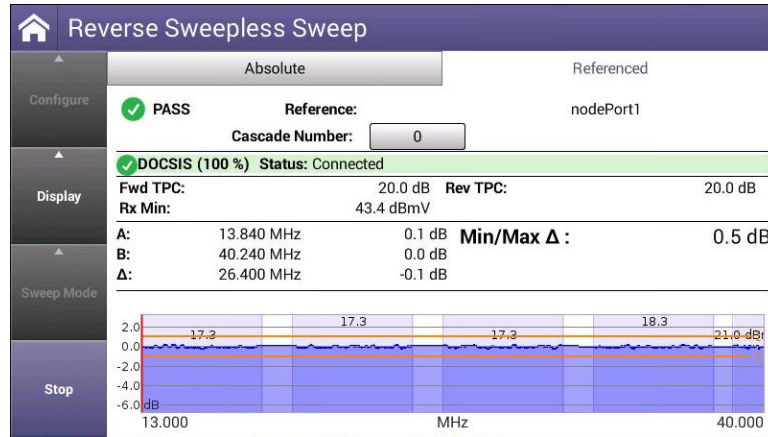

About 2.5 dB additional attenuation in this portion of the network than when compared to the originally referenced sweep response trace – Indicating there is 2.5dB of relative loss at this test location and should be corrected

Referenced Tab – Continued

Referenced Sweep Limit Threshold

DOCSIS Communication Status

Forward Test Point Compensation Value

Minimum Received Downstream Channel level

Marker A & B Information:
Frequency, the delta (loss / gain) between the originally referenced trace and the currently measured trace
Delta – difference in marker frequency and marker response difference

[Configure Menu](#)
[Display Menu](#)

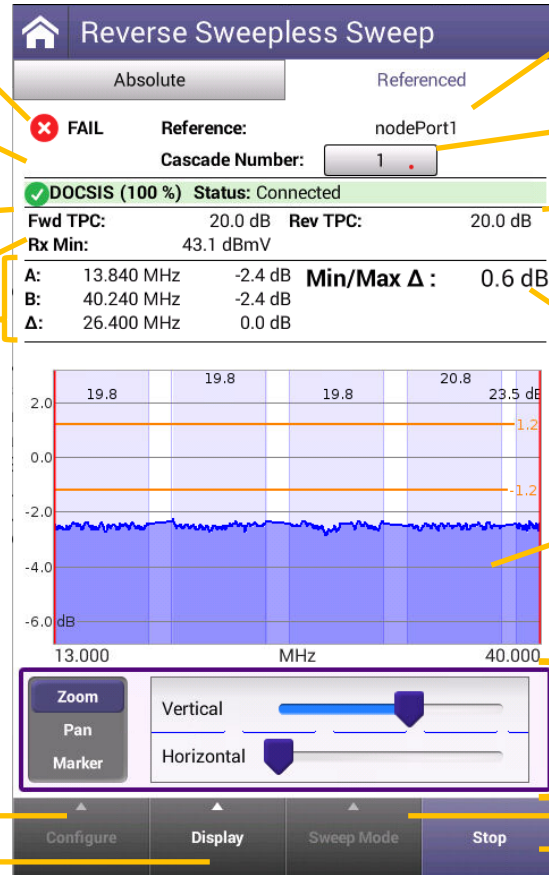

The Reference File Name (None – if no reference is set)

Place amplifier cascade

Reverse Test Point Compensation Value

Minimum or Maximum delta in the trace between the markers

The referenced trace displays frequency response deltas between the original trace and the currently measured trace

Graphical and Marker Adjustments
[Zoom, Pan, Marker](#)

Go to Forward or Reverse Sweep Stop / Start the test

Reference Bandwidth (Ref BW)

- Reference Bandwidth adjusts how the ONX displays each upstream channel's power relative to the selected bandwidth
- Most techs know Upstream SC-QAM's transmitted power relative to a common 6.4MHz bandwidth
- Due to the variability of OFDMA channel widths, DOCSIS spec uses a 1.6MHz wide bandwidth for OFDMA channels
- On the ONX the Modem Default shows the transmit power for the SC-QAM's based on the channel's bandwidth of 3.2MHz or 6.4MHz and OFDMA channels based on the spec of 1.6MHz
- Selecting a Reference Bandwidth of either 1.6MHz or 6.4MHz will adjust the displayed channel transmit power levels for all channels of all types based on the selected bandwidth
 - 1.6MHz Ref BW 6.4MHz SC-QAMs will appear 6dB lower
 - 6.4MHz Ref BW OFDMA carriers appear 6dB higher

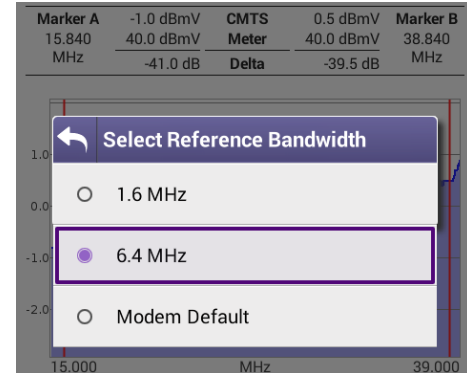
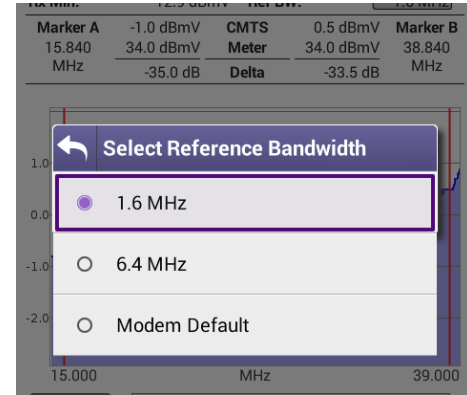

Graphical and Marker Adjustments

Zoom – Same as Pinch and Zoom on touch screen

- Vertical - Adjusts the dB/div
- Horizontal - Adjusts the frequency span

Pan – Adjust the bars to change the frequency span and slide the bar left or right to quickly change the displayed start and stop frequency based on the span

Marker – Select the “Marker A” or “Marker B” to move that marker left or right with the arrow keys

- CMTS values will adjust based on the frequency selected
- Markers can also be moved via touch screen

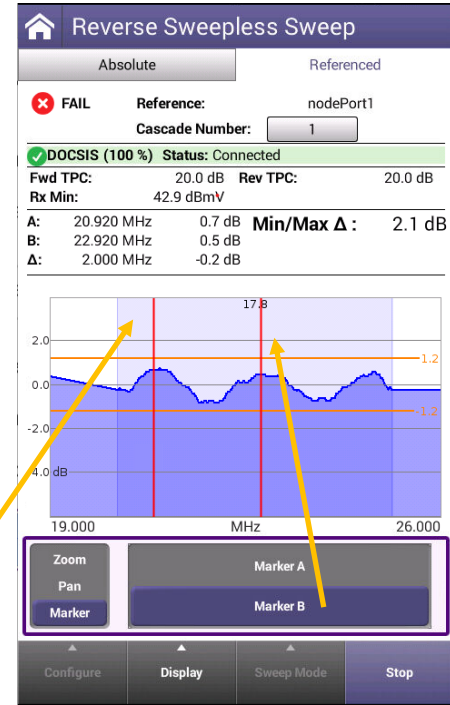
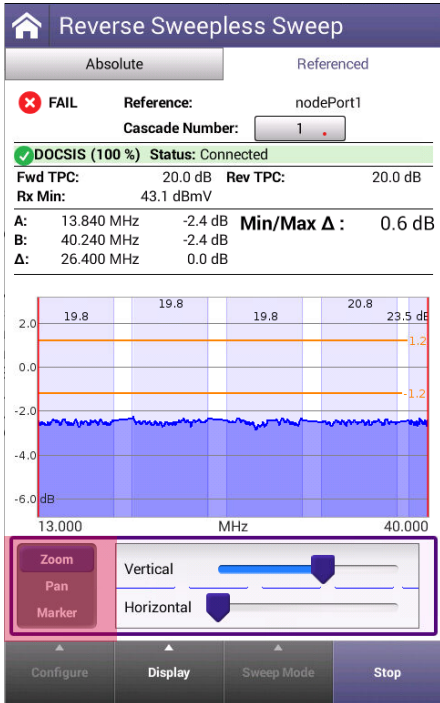

Sweepless Sweep

Sweepless Sweep Configure

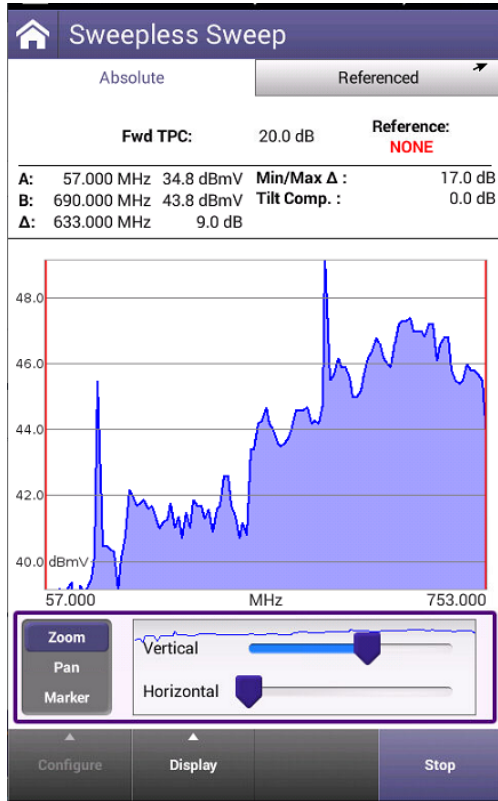

The 'Sweep Config' menu is shown, which is accessed from the 'Configure' button in the main interface. It contains the following options:

- Sweep Config**
Modify Sweep Configuration
- Configure Test Point**
+20.0 dB TPC 1
- Choose Reference**
Set reference sweep data
- Save Test/Reference**
Save current test to a Work Order
- View Tests**
View previous tests

The 'Configure Sweep' menu is shown, which is accessed from the 'Sweep Config' menu. It contains the following options:

- Configure Sweep**
- Changes will restart test**
- Enable Sweep Limit**
- Sweep Limit
4.0 dB

Sweepless Sweep Configure

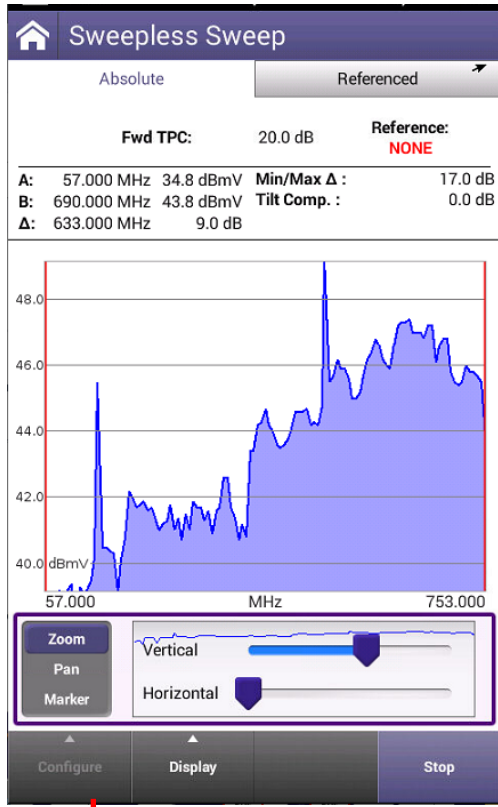

Sweep Config
Modify Sweep Configuration

Configure Test Point
+20.0 dB TPC 1

Choose Reference
Set reference sweep data

Save Test/Reference
Save current test to a Work Order

View Tests
View previous tests

Configure Test Point Template

+20.0 dB TPC 1

Forward Test Point Compensation
20.0 dB

Forward Tilt Compensation
0.0 dB

Forward Low Tilt Frequency
54.000 MHz

Forward High Tilt Frequency
860.000 MHz

Select Test Point Template

+0.0 dB TPC

+20.0 dB TPC

+20.0 dB TPC 1

View / Edit | Delete | Copy | Done

Sweepless Sweep Clear Reference

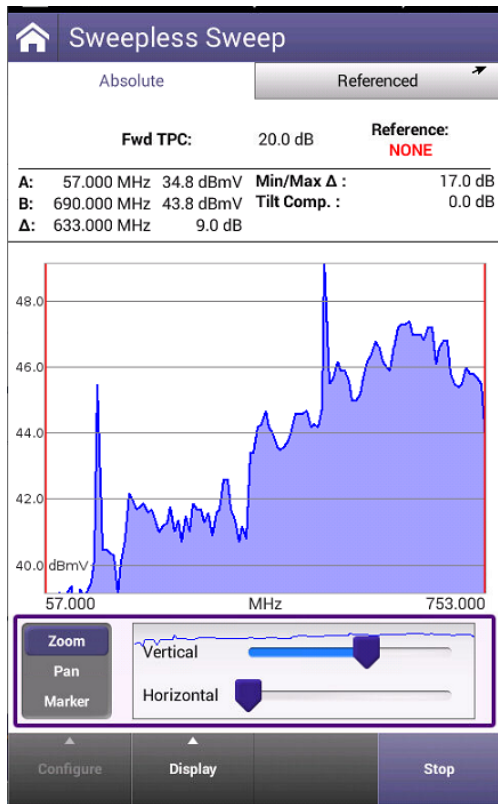

The 'Sweep Config' menu is shown, containing the following options:

- Sweep Config
Modify Sweep Configuration
- Configure Test Point
+20.0 dB TPC 1
- Choose Reference**
Set reference sweep data
- Save Test/Reference
Save current test to a Work Order
- View Tests
View previous tests

A red box highlights the 'Choose Reference' option.

The 'Sweepless Sweep Reference' menu is shown, containing the following options:

- Sweepless Sweep Reference
- Work Order
- Recent References
- Reverse Reference
From Work Order: NONE
- Tests for Current Work Order:
- Work Order ID
44
- Clear Reference**
- Set Reference

A red box highlights the 'Clear Reference' option.

Sweepless Sweep Save File or Reference

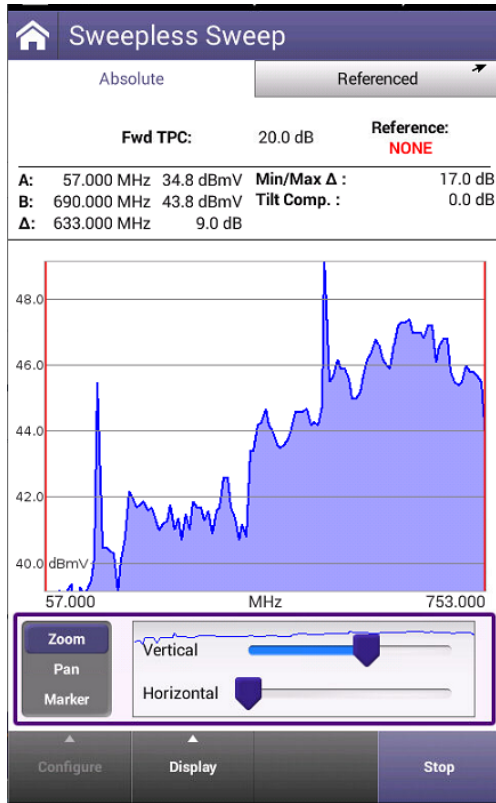

The 'Sweep Config' menu is shown as a floating window. It contains the following options:

- Sweep Config**: Modify Sweep Configuration
- Configure Test Point**: +20.0 dB TPC 1
- Choose Reference**: Set reference sweep data
- Save Test/Reference**: Save current test to a Work Order
- View Tests**: View previous tests

Red arrows indicate the flow from the 'Configure' button in the main interface to this menu, and from the 'Save Test/Reference' option to the 'Save Sweepless Sweep Test' screen.

The 'Save Sweepless Sweep Test' dialog is shown as a floating window. It contains the following information and options:

- Save Test to Work Order**
- Test Name**: node333refforward
- Work Order ID**: 44
- Set as Reference**
- Set Name to Current Date** (button)
- Save** (button)

Red arrows indicate the flow from the 'Save Test/Reference' option in the 'Sweep Config' menu to this dialog, and from the 'Save' button back to the main interface.

Sweepless Sweep Configure

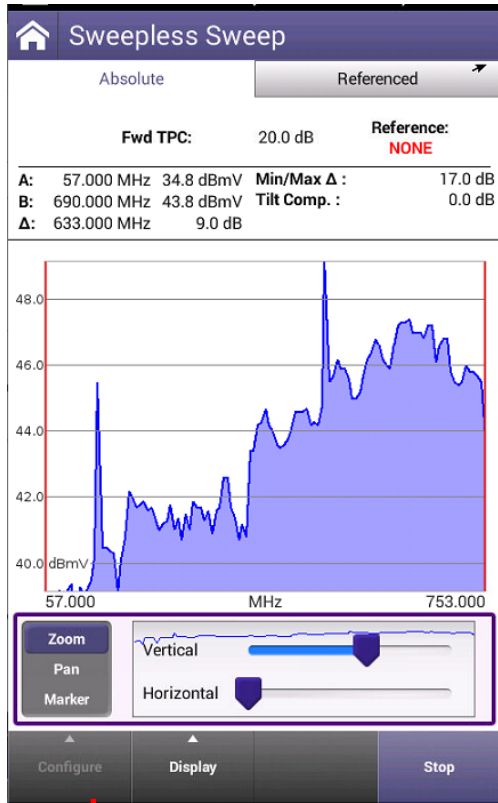

The screenshot shows the 'Sweep Config' menu with the following options:

- Sweep Config**
Modify Sweep Configuration
- Configure Test Point**
+20.0 dB TPC 1
- Choose Reference**
Set reference sweep data
- Save Test/Reference**
Save current test to a Work Order
- View Tests**
View previous tests

The 'View Tests' option is highlighted with a purple border. Red arrows indicate the flow from the 'Configure' button in the first screenshot to this menu, and from the 'View Tests' option to the next screenshot.

The screenshot shows the 'Sweepless Sweep Tests' screen. At the top, there is a back arrow and the title 'Sweepless Sweep Tests'. Below this, it says 'Tests for Current Work Order:'. The main area is empty. At the bottom, there is a 'Work Order ID' field with the value '44'. A 'View Results' button is located at the bottom right.

Sweepless Sweep Configure

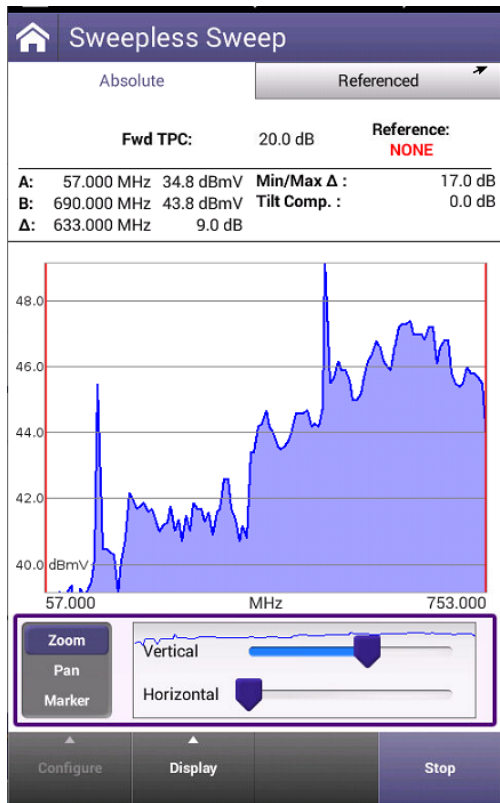

Auto Reference

dB/div
2.0 dB

Marker Frequencies
A: 57.00 MHz B: 757.25 MHz

Rotate Screen
Portrait

← dB/div

1.0 dB

2.0 dB

5.0 dB

10.0 dB

20.0 dB



Sweepless Sweep Absolute and Referenced

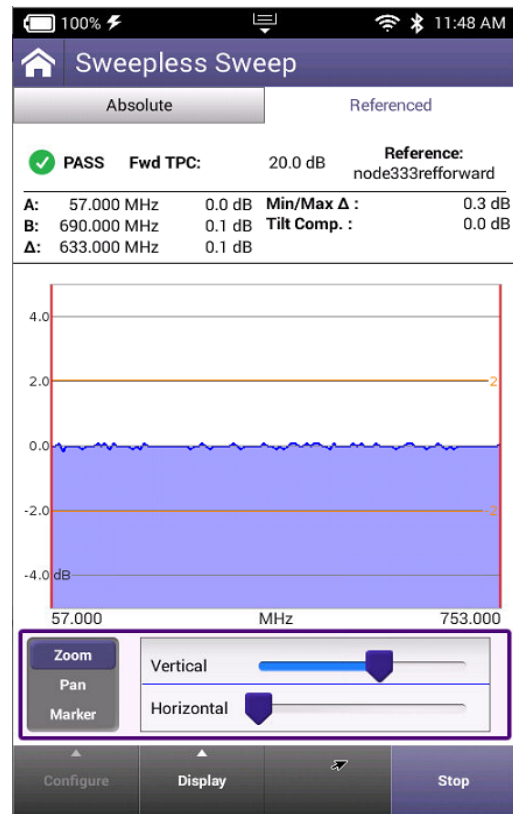

Sweepless Return Sweep

Reverse Sweepless Sweep Configure and Test Point

Reverse Sweepless Sweep

Reference: **NONE**

DOCSIS (100%) Status: Connected

Fwd TPC:	20.0 dB	Rev TPC:	20.0 dB
Rx Min:	32.2 dBmV	Ref BW:	Modem Default

Marker A	-0.6 dBmV	CMTS	0.1 dBmV	Marker B
13.840 MHz	33.0 dBmV	Meter	33.0 dBmV	40.240 MHz
	-33.6 dB	Delta	-32.9 dB	

Graph: 4.0 dBmV to -4.0 dBmV vs 13.000 MHz to 40.000 MHz

Controls: Zoom, Pan, Marker, Configure, Display, Sweep Mode, Stop

Sweep Config
Modify Sweep Configuration

Configure Test Point
+20.0 dB TPC 1

DOCSIS Service Plan
00:07:11:1F:8C:12

Choose Reference
Set reference sweep data

Save Test/Reference
Save current test to a Work Order

View Tests
View previous tests

Select Test Point Template

- +0.0 dB TPC
- +20.0 dB TPC
- +20.0 dB TPC 1**

Buttons: View, Delete, Copy, Done

Configure Sweep

Changes will restart test

Enable Sweep Limit

Sweep Limit
4.0 dB

Configure Test Point Template

+20.0 dB TPC 1

Forward Test Point Compensation
20.0 dB

Reverse Test Point Compensation
20 dB

Reverse Sweepless Service plan Select

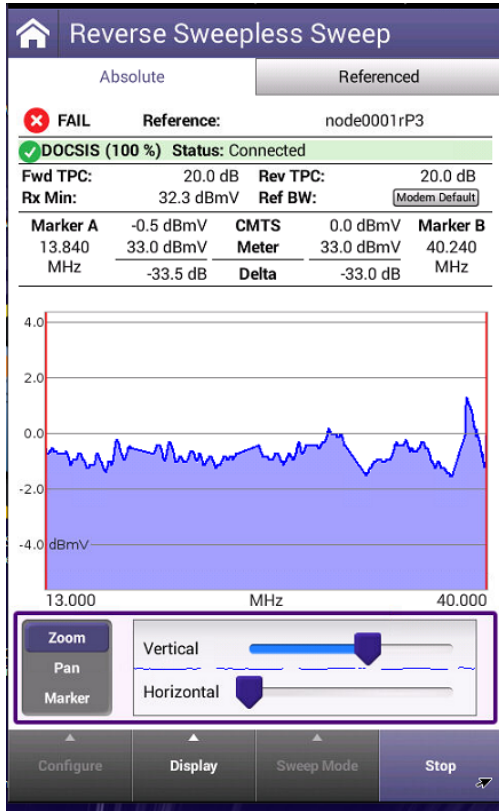

- Sweep Config**
Modify Sweep Configuration
- Configure Test Point**
+20.0 dB TPC 1
- DOCSIS Service Plan**
00:07:11:1F:8C:12
- Choose Reference**
Set reference sweep data
- Save Test/Reference**
Save current test to a Work Order
- View Tests**
View previous tests

Reverse Sweepless Sweep Reference

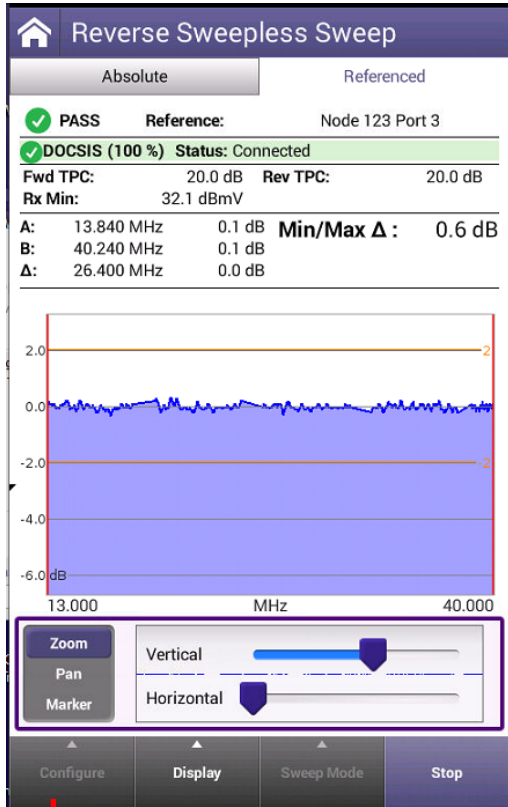

Sweep Config
Modify Sweep Configuration

Configure Test Point
+20.0 dB TPC 1

DOCSIS Service Plan
00:07:11:1F:8C:12

Choose Reference
Set reference sweep data

Save Test/Reference
Save current test to a Work Order

View Tests
View previous tests

Reverse Sweep Reference

Work Order Recent References

Reverse Reference NONE

From Work Order:

Tests for Current Work Order:

Work Order ID
3434

Clear Reference Set Reference

Save Reverse Sweep Test

Save Test to Work Order

Test Name
Node 123 Port 3

Work Order ID
3434

Set as Reference

Set Name to Current Date Save

Reverse Sweepless Sweep Type

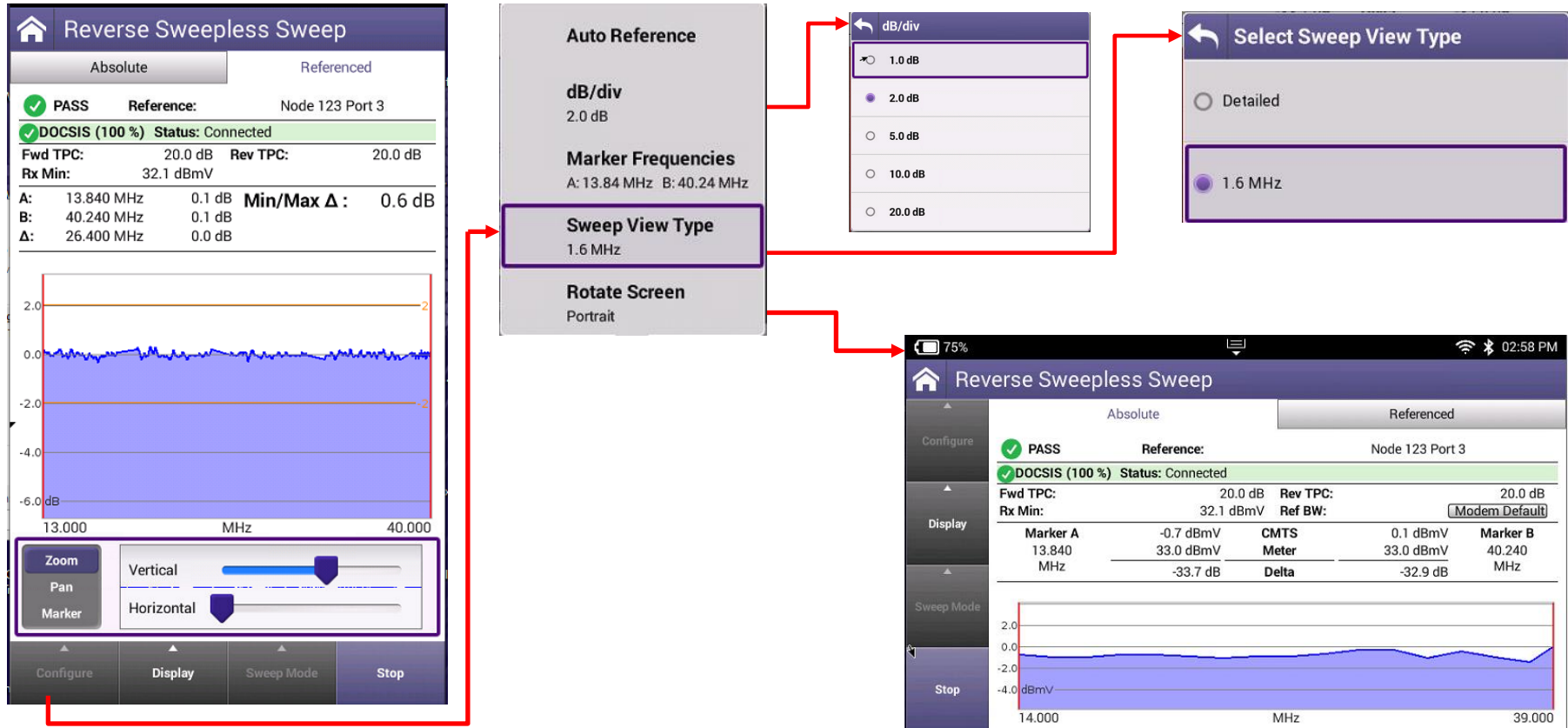

Reverse Sweepless Sweep Absolute and Referenced

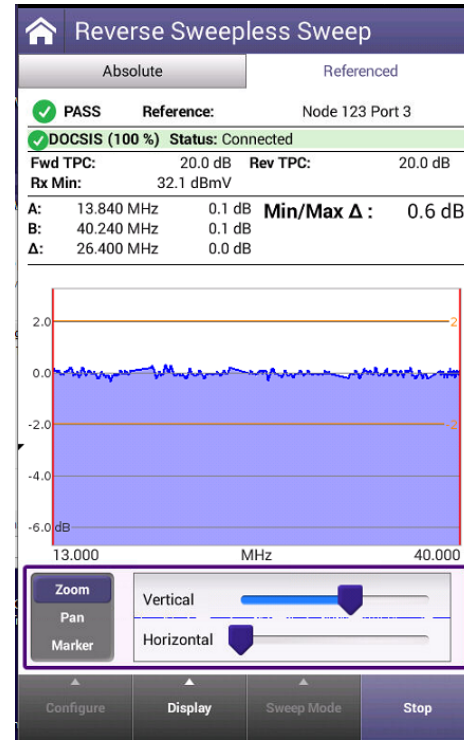
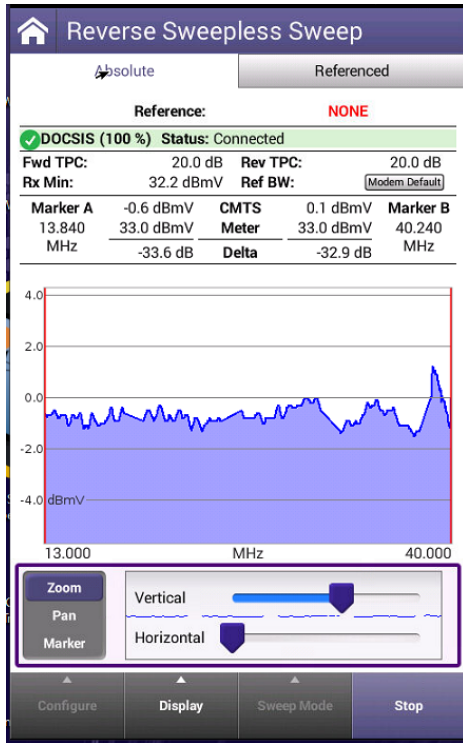

Typical Reverse Sweep Errors

Telemetry not found

Sweep Error

Telemetry Not Found

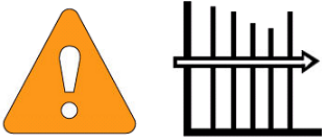

Sweep was not able to obtain telemetry.
Check if telemetry frequency is configured correctly
If signal levels are high, configure your test point for High Power Environment

Stop Retry

Forward Sweep | Single User Reverse Sweep

Sweep Settings

Forward Telemetry Frequency (MHz)

Forward Telemetry Level (dBmV)

Forward Sweep Level (dBmV)

Reverse Telemetry Frequency (MHz)

Automatically start sweep at power on

Submit Query

Multi User Reverse Sweep

Sweep Settings

Forward Telemetry Frequency (MHz)

Forward Telemetry Level (dBmV)

Reverse Telemetry Frequency (MHz)

Automatically start sweep at power on

Submit Query

Configure Sweep

Changes will restart test

SDA 5500 Telemetry Frequency
52.000 MHz

SDA 5510 Telemetry Frequency
53.000 MHz

Reverse Sweep User Mode
Single User

Enable Sweep Limit

Digital carrier bandwidth
6.000 MHz

Sweep Limit
3.0 dB

Configure Sweep

Changes will restart test

SDA 5500 Telemetry Frequency
52.000 MHz

SDA 5510 Telemetry Frequency
53.000 MHz

Reverse Sweep User Mode
Multi User

Enable Sweep Limit

Digital carrier bandwidth
6.000 MHz

Sweep Limit
3.0 dB

Invalid Telemetry

Invalid Telemetry

•3 possibilities

•#1. Using the multiple user frequency when sweeping the forward sweep single sweep or when sweeping forward. using multiple users frequency

Verify correct telemetry.

•#2. The input level is of telemetry exceed +25 dBmV into ONX

•#3. RF channel power into the ONX exceeds 20 dBmV.

Check the High Power Environment in the Test Point template

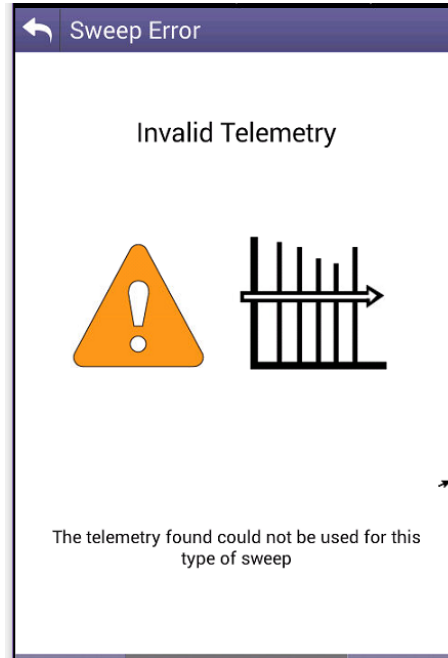

Figure 4: High Power setting

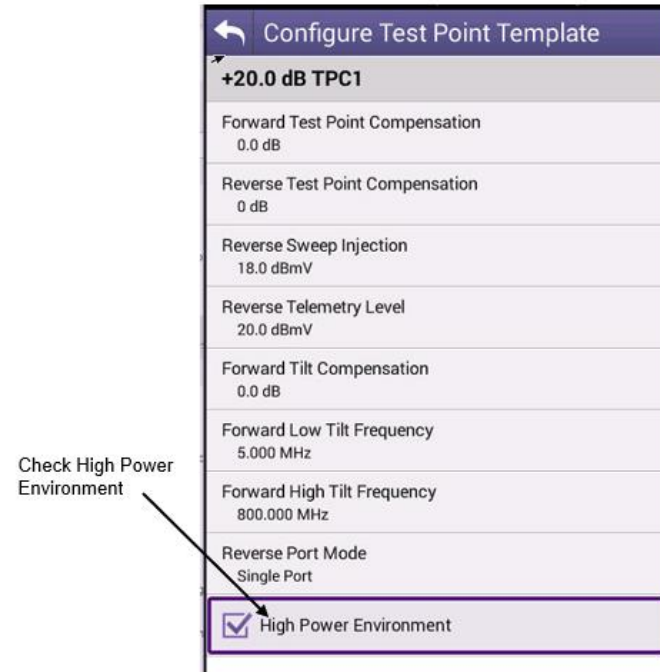
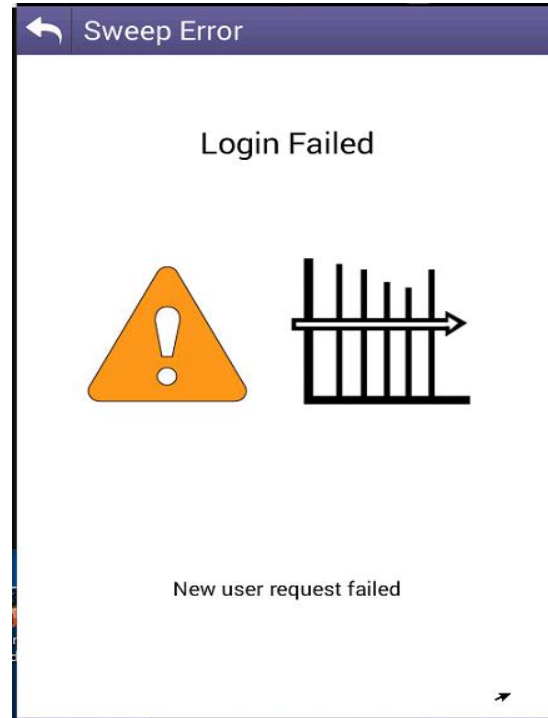

Figure 5: High Power setting

Login Failure

Return Sweep Error

- Login Failure
- Typically cause by the return Telemetry level is to low for the SCU-1800 to decode or not present at the SCU-1800
- Return Telemetry > 30 dB to the input of the SCU-1800
- Too much return RF power into the SCU-1800



Sweep Offline

- Sweep Offline
- Verify Reverse Sweep is check on SDA 5500 return sweep is on
- Too much return RF power. Verify out put on ONX is not too high.
- **Please Review SCU-1800 Getting Started Guide**



QAM Video Option



Need for Video Verification

- RPD Installation process step: RF verification and adjustment, provisioning verification
 - Each node port/service group can have a unique configuration
 - Adds process complexity, incorrect configuration provisioning is common

Common Configuration Problems

- A QAM carrier specified in Logical Channel Plan (LCP) is missing or impaired
- Programs defined in the LCP are not mapped within the QAM (missing PID/Program)
- Programs defined in the LCP are mapped to the QAM but there is no data in the program (stalled PID)
- Programs defined in the LCP are mapped to share same frequency as a DOCSIS carrier
- Out of Band (OOB) carriers are not enabled
- OOB Carrier is enabled but no data is flowing



<5 Minute Comprehensive RF/Service Test at RPD Output

Was:

- 30+ minutes/port
- Multiple STB's + TV
- Paper checklist
- Temp drop to truck
- Sampling only
- Error-prone

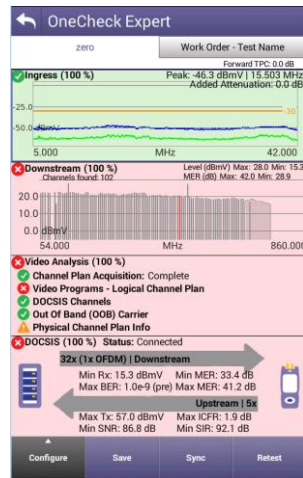
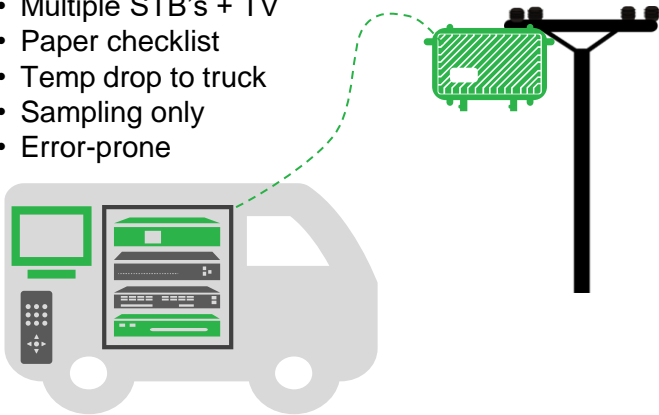

Is Now:

- <5 minutes/port
- Uses existing meter
- Comprehensive/100%
- Automated/Error-proof test



Efficiently verify **ALL** services present/operating properly on RPD RF output in <5 min

- Verify all DS/US RF and DOCSIS service characteristics
- Verify every program in the logical channel plan(LCP) is active and running on the specified QAM carrier
- Test that the OOB carrier is active and supplying data
- All in <5 min using meter Techs already carry

Video Verification Test Recommendations

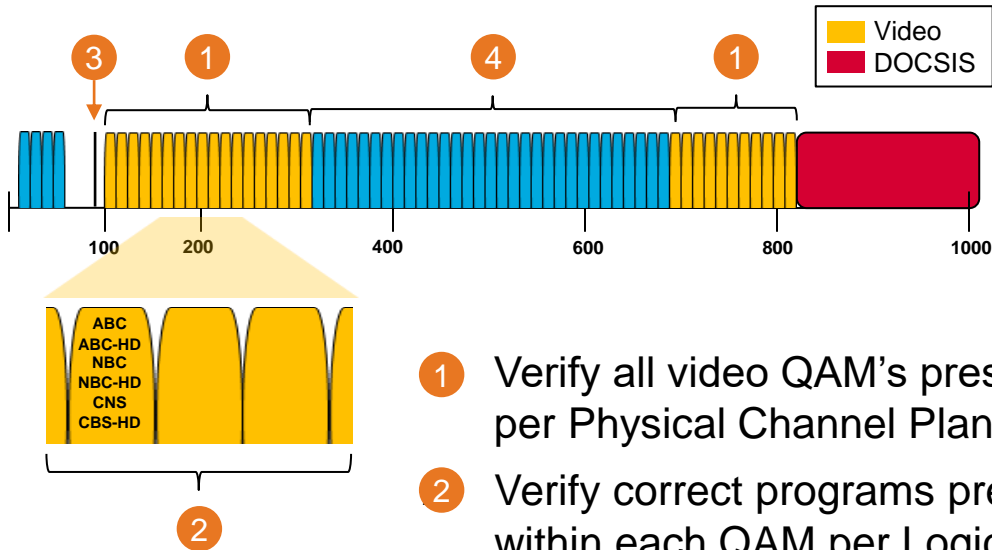

- 1 Verify all video QAM's present at right freq's per Physical Channel Plan, not impaired
- 2 Verify correct programs present / active within each QAM per Logical Channel Plan
- 3 Verify Out of Band (OOB) carriers active and supplying data
- 4 Verify DOCSIS is not sharing channel with video



RF & DOCSIS/Video Service Certification Recommendations

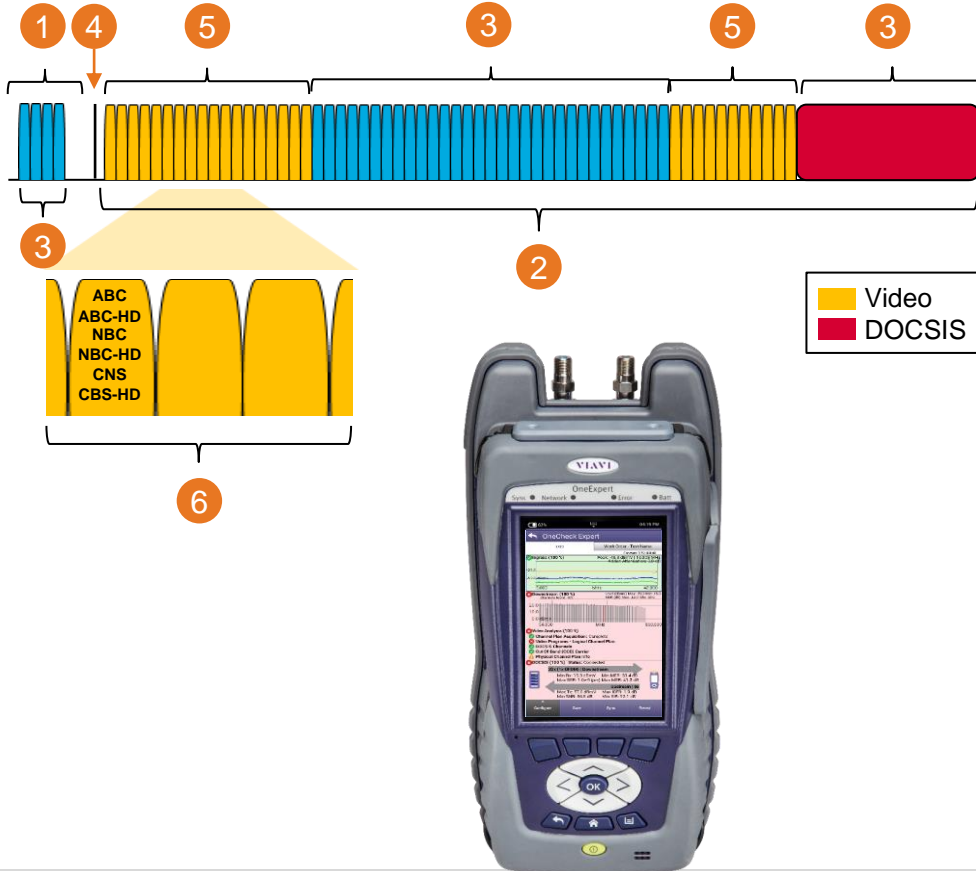

- 1 Verify no upstream ingress present in network downstream of RPD
- 2 Full System Analysis: Level, MER, Pre/Post BER, Echo, GD, ICFR, Hum, DQI on Every Channel
- 3 Full DOCSIS analysis of US and DS (OFDM/ODMA/ SC QAM), including Bonding, Profile Analysis, Through Put and Packet Quality
- 4 Verify Out of Band (OOB) carriers active and supplying data
- 5 Verify all video QAMs present at right frequencies per Physical Channel Plan, not impaired
- 6 Verify correct programs present / active within each QAM per Logical Channel Plan

Plus Upstream and downstream Sweep

Video Test Identifies Configuration Problems

Video Test incorporated into OneCheck Expert

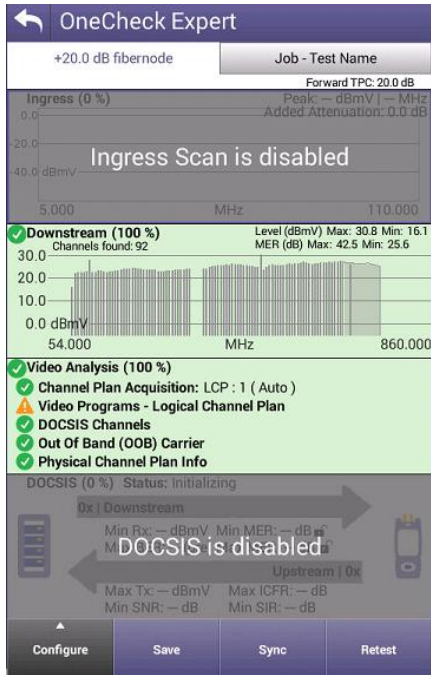

Video Analysis General Overview

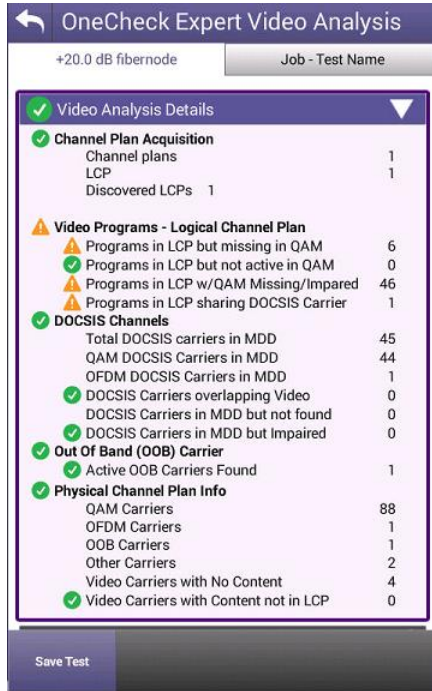

Physical Plant Analysis See missing programs

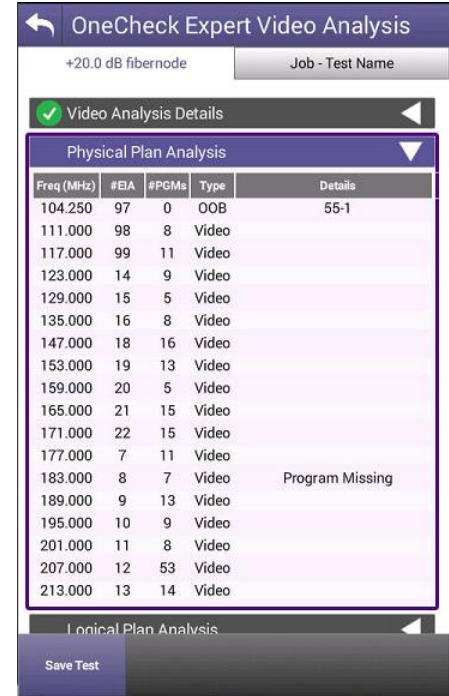

Video Test Identifies Configuration Problems

Logical Plan Analysis
See missing QAMs

OneCheck Expert Video Analysis

+20.0 dB fibernode Job - Test Name

Video Analysis Details

Physical Plan Analysis

Logical Plan Analysis

Freq (MHz)	LCN	Name	Active	Details
75.250	3542	CASMRCDL17	No	QAM Missing
75.250	3544	CASMRCDL18	No	QAM Missing
75.250	3545	CASMRCDL19	No	QAM Missing
75.250	3546	CASMRCDL20	No	QAM Missing
75.250	3547	CASMRCDL21	No	QAM Missing
75.250	3549	CASMRCDL22	No	QAM Missing
75.250	3552	CASMRCDL23	No	QAM Missing
75.250	3553	CASMRCDL24	No	QAM Missing
75.250	3554	CASMRCDL25	No	QAM Missing
93.000	91	LOCA1	No	QAM Missing
93.000	92	LPROG2	No	QAM Missing
111.000	265	INDHDC	Yes	
111.000	543	PLYBPRM	Yes	
111.000	546	CTNXX5P	Yes	
111.000	547	CHSTLRP	Yes	
111.000	548	CJUICY	Yes	
111.000	549	CPFNTHP	Yes	

Save Test

DOCSIS MDD Mac Domain Descriptor
Analysis
See missing QAMs

OneCheck Expert Video Analysis

+20.0 dB fibernode Job - Test Name

Video Analysis Details

Physical Plan Analysis

Logical Plan Analysis

DOCSIS MDD Analysis

Freq (MHz)	Primary	Type	Details
405.000	Yes	QAM	
411.000	No	QAM	
417.000	No	QAM	
423.000	No	QAM	
429.000	Yes	QAM	
435.000	No	QAM	
441.000	No	QAM	
447.000	No	QAM	
453.000	Yes	QAM	
459.000	No	QAM	
465.000	No	QAM	
471.000	No	QAM	
477.000	Yes	QAM	
483.000	No	QAM	
489.000	No	QAM	

Save Test

New MPEG Video option for DAA/RPHY turnup verification

Description	Catalog #	Option Type
QAM Video MPEG verification option	ONX-CATV-SW-QAM-VIDEO	New unit option available on ONX-630 NTX and ONX630 SWX
Field Upgrade via SS - QAM Video MPEG verification option	UPG-ONX-CATV-SW-QAMVIDEO	Field Upgrade to add QAM Video option to ONX-630 NTX and ONX-630 SWX



VI.AVI Solutions