

Engineered Diffusers – Intensity vs. Irradiance

Engineered Diffusers® are specified by their divergence angle and intensity profile. The Divergence Angle is usually defined as the full width at half maximum (FWHM) of the intensity profile normalized to the center, in the horizontal and vertical directions. The intensity profile is the shape of the light distribution measured as a function of angle.

Intensity

Intensity, or more accurately, radiant intensity, is defined as the flux or power per unit solid angle emitted by an optical component into a given direction. Mathematically it can be expressed as

$$I = \frac{d\Phi}{d\Omega} \tag{1}$$

where $d\Phi$ is the flux or power emitted into the solid angle $d\Omega$. This quantity is most accurate when the observation distance from the diffuser is significantly larger than the size of the illumination area on the diffuser. The intensity is always expressed as a function of the scattering angles, θ and ϕ as shown in Figure 1. For symmetric diffusers, the intensity is a function of only the polar angle θ .

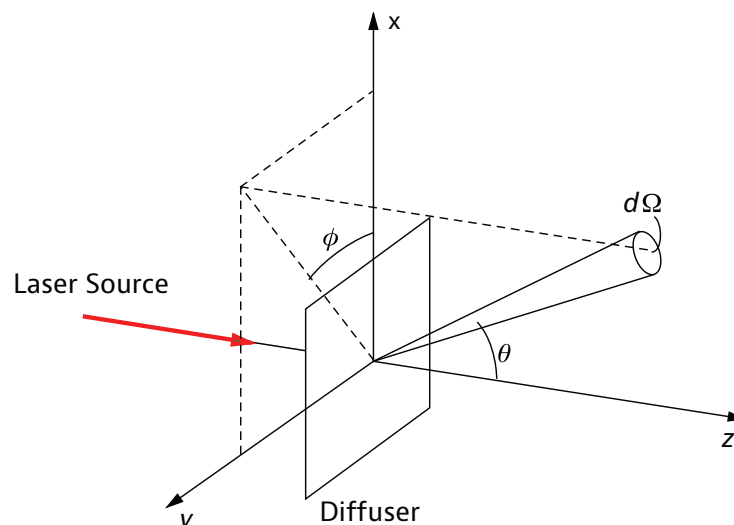

Figure 1. Radiant intensity as a function of scattering angles

Irradiance

Irradiance is a different measure of a light distribution. Irradiance is the flux or power per unit area received by a surface element, and is given by the formula

$$E = \frac{d\Phi}{dA} \tag{2}$$

Figure 2 below shows a surface element dA illuminated by a point source a distance r from the surface.

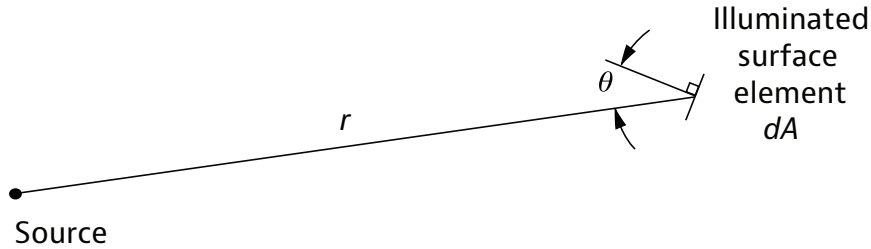

Figure 2. Surface element illuminated by a point source

The surface element dA subtends a solid angle $d\Omega$ relative to the source given by $d\Omega = dA \cos\theta / r^2$, where $dA \cos\theta$ is the projected area of the surface element relative to the source. Using the formula for the intensity in Eq. (1) we can express the irradiance as

$$E = \frac{d\Phi}{dA} = \frac{I \cos\theta}{r^2} \tag{3}$$

The irradiance on a surface is proportional to the intensity I , and depends upon the angle of incidence as $\cos\theta$. The irradiance obeys the inverse-square law, decreasing with increasing distance as $1/r^2$.

Measurement of Intensity

VIAVI Engineered Diffusers are specified by the intensity distribution they produce. The intensity is measured using a high precision in-house scatterometer capable of measuring seven orders of magnitude of intensity variation. The basic layout is shown in Figure 3.

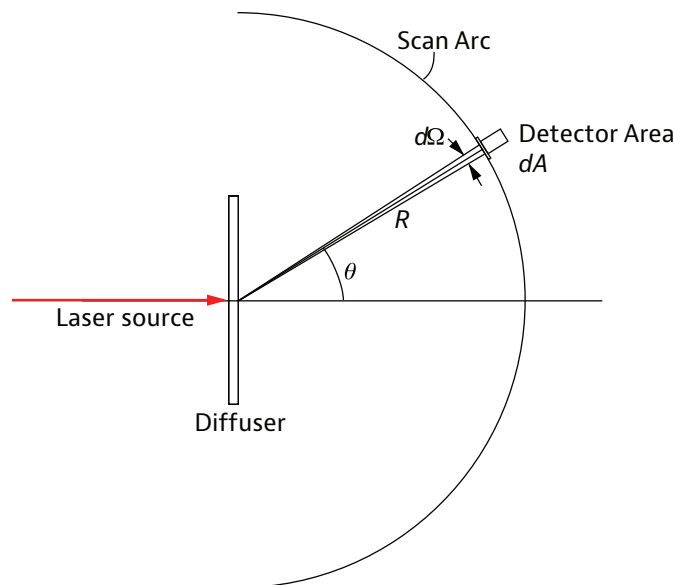

Figure 3. Principle of measurement of intensity

The diffuser is illuminated with a laser source at normal incidence. A detector, mounted on a rotating arm, scans a full 180° arc to record the intensity distribution. Since the arm rotation is centered at the diffuser, the detector maintains a fixed distance, R , from the diffuser; the distance R is large compared to the spot size of the laser on the diffuser. In addition, the detector always faces the diffuser. Thus the detector subtends a fixed solid angle for all measurement positions.

The benefit of this type of system is that the measurement covers a full $\pm 90^\circ$ angular range. The size of the detector is small so that the structure of the intensity distribution is recorded. This can lead to noisy data due to the speckle created from using a coherent laser source. The speckle can be smoothed by processing the data. Figure 4 shows the raw data of the intensity distribution from an EDC-15 Engineered Diffusers, smoothed data obtained by averaging over 1° , and the fit to a flat-top distribution.

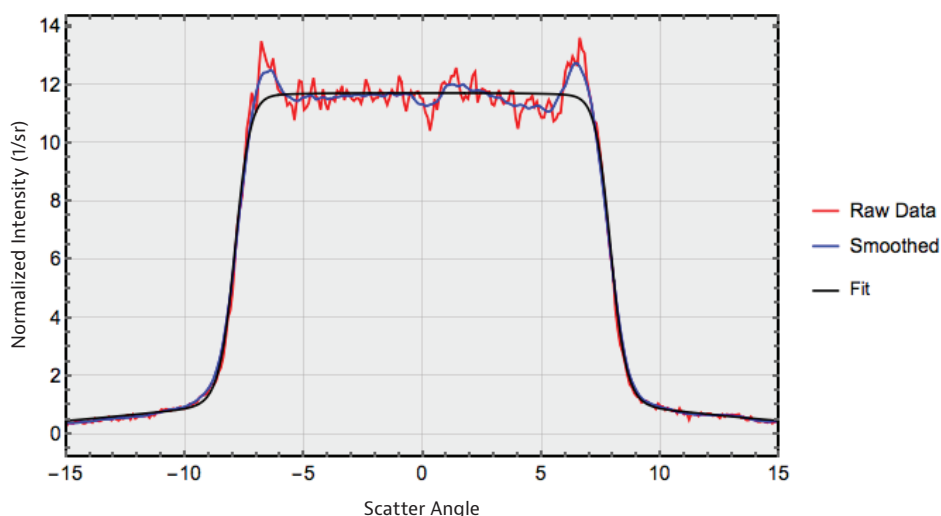

Figure 4. Intensity Distribution for EDC-15 Engineered Diffuser

Irradiance on a Planar Surface

Irradiance is commonly measured on a planar surface a distance R away from the diffuser as shown in Figure 5. The irradiance in the xy plane is measured by moving the detector along the x -axis and recording the received power. The detector is kept parallel to the xy plane so that, as the detector moves along the x -axis, the projected area of the detector relative to the diffuser decreases by $\cos\theta$.

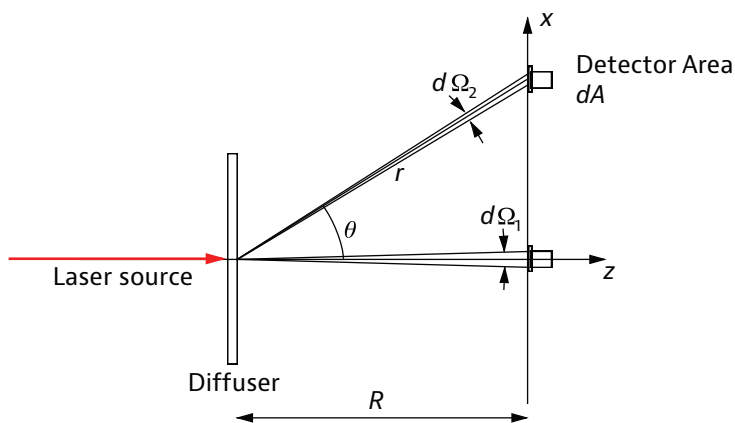

Figure 5. Principle of measurement of irradiance

As the detector is moved along the x -axis, the distance r from the diffuser to the detector increases by $R/\cos\theta$ from the on-axis value of R . Thus, the irradiance measured in the xy plane can be written as

$$E = \frac{I \cos^3\theta}{R^2} \quad (4)$$

Equation (4) illustrates a fundamental difference between intensity and irradiance; the irradiance falls off as a $\cos^3\theta$ compared to the intensity. To illustrate this difference between intensity and irradiance one may compare these values for the EDC-60 Engineered Diffuser. This diffuser is designed to have a uniform, flat-top intensity distribution with a width of 60° as shown in Figure 6.

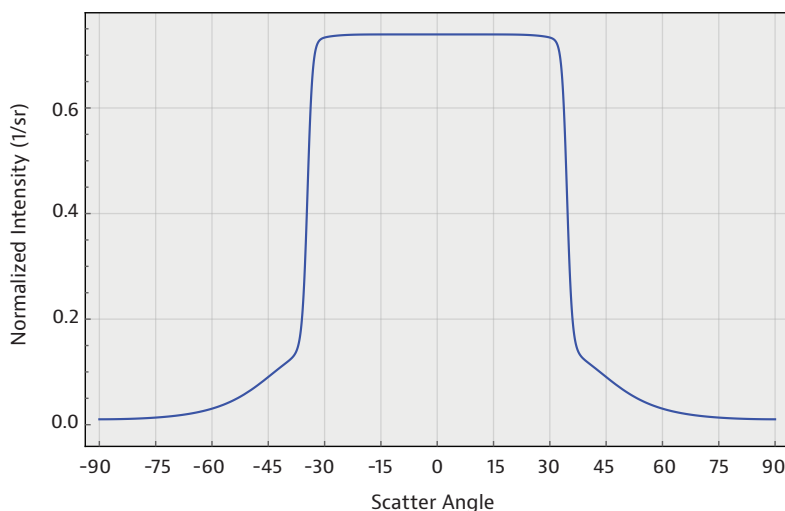

Figure 6. Intensity Distribution for EDC-60 Engineered Diffuser

The irradiance distribution in a plane at an arbitrary distance R away from the diffuser is obtained by multiplying the intensity by $\cos^3\theta$. The result, normalized by $1/R^2$, is shown in Figure 7.

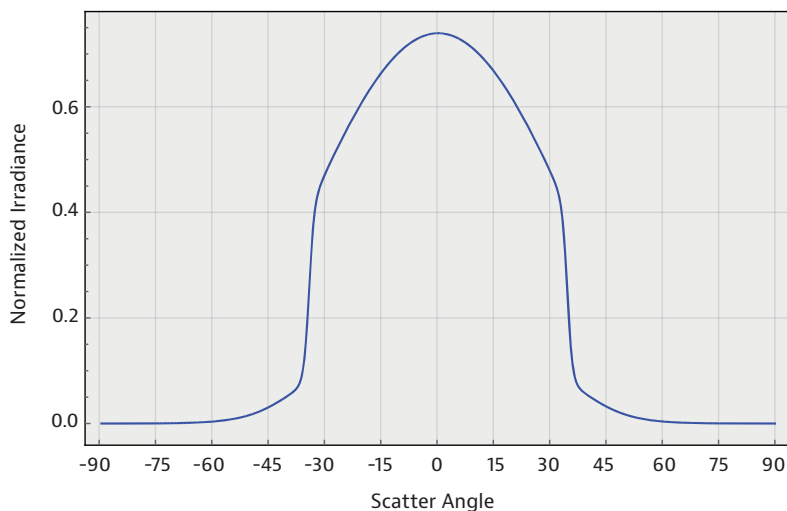

Figure 7. Irradiance Distribution for EDC-60 Engineered Diffuser

The diffuser performance plotted in Figure 7 depicts a non-uniform irradiance that varies radially. If the diffuser is designed for illumination of a planar surface, one may prefer to have a diffuser that produces a uniform, flat-top irradiance. An example of this is shown in Figure 8, for a diffuser producing an output with a 60° beam divergence; the irradiance distribution is normalized by $1/R^2$.

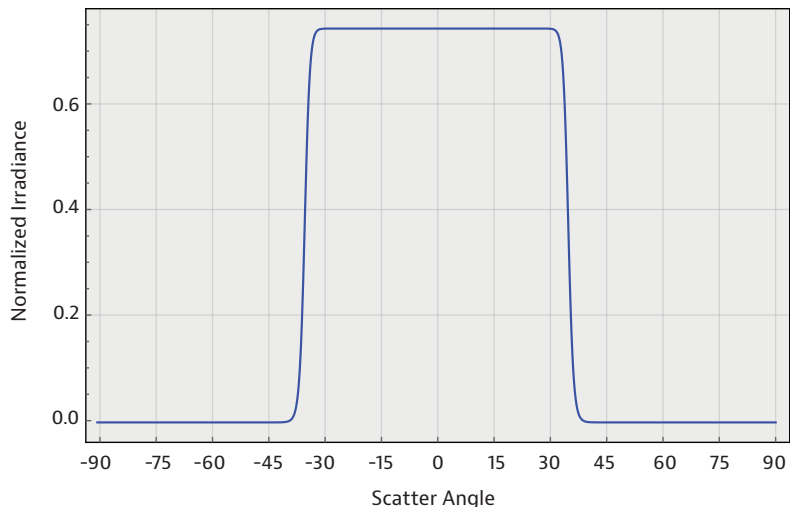

Figure 8. Uniform Irradiance Distribution

The intensity distribution required to generate this flat-top irradiance is calculated from Eq. (4) by solving for the intensity. The result is the irradiance normalized by R^2 and divided by $\cos^3\theta$. This is illustrated in Figure 9.

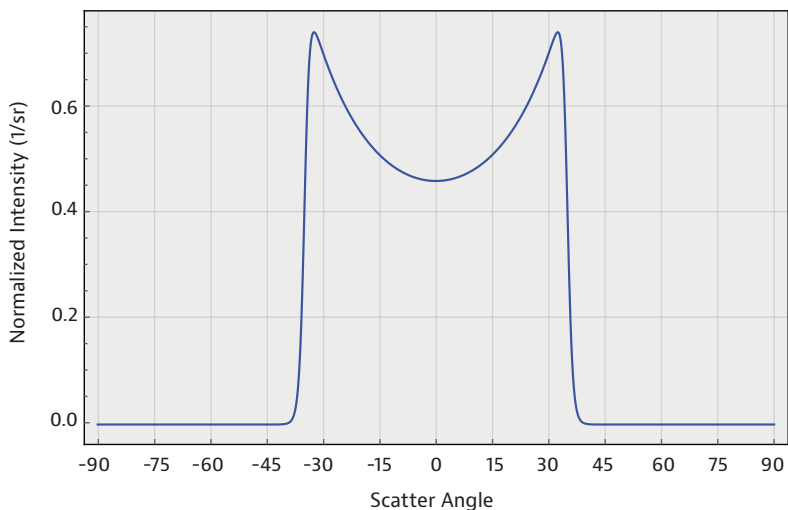

Figure 9. Intensity Distribution for Uniform Irradiance

The intensity distribution plotted here is termed a “bat-wing” profile, and is the intensity profile necessary to produce a flat-top irradiance measured on a planar surface. This shows the dramatic difference between specifying a uniform intensity distribution versus a uniform irradiance distribution. VIAVI has the ability to produce a variety of diffusers, whether they have uniform intensity, uniform irradiance, or another distribution as specified by the customer.