

# A Complete Synchronization Tool Kit from VIAVI

5G synchronization across the transport, radio and resilience layers



## ABOUT VIAVI

For over 100 years, VIAVI Solutions has been directly involved in testing, assuring and securing the largest communications network around the globe, and validating network products for all Tier-1 network equipment manufacturers. VIAVI has been helping over 200 service providers and almost all major 5G suppliers to navigate technology evolution and deliver on their promise of quality from 2G to 5G and beyond. Our synchronization Toolkit provides comprehensive solutions for network installation and maintenance, with focus on resiliency, transport, lab and performance testing, and radio verification.



# TABLE OF CONTENTS

- Synchronization: The Backbone of Seamless, Ultra-Reliable 5G Communications.....4**
  - 5G Synchronization ..... 5
  - Synchronization in the Lab..... 6
- Mastering Transport Layer Dynamics..... 7**
  - Deploying 5G: Synchronization Use Cases and Challenges..... 8
  - Key Synchronization Technologies and Standards..... 9
  - Testing to Ensure Precision in 5G Synchronization .....10
- Ensuring Radio Precision..... 11**
  - The Importance of Radio Synchronization.....12
  - Challenges and Strategies Deployment .....14
  - Solutions for Testing Radio Precision..... 16
  - Navigating Time Synchronization Using PTP ..... 17

- Strengthening Network Resilience .....18**
  - The Role of STL in Achieving Network Resilience ..... 19
  - Ensuring Resilience in the Staging Phase..... 20
  - Managing Multiple Time Sources ..... 21
- Product Summary .....23**
- Conclusion .....24**



SYNCHRONIZATION:

# The Backbone of Seamless, Ultra-Reliable 5G Communications

## 5G Synchronization: A Pillar for Performance, Reliability and the Seamless Execution of Services

With 5G's promise of ultra-fast speeds, low latency and massive connectivity, synchronization ensures that data packets across sprawling networks arrive not only quickly but in perfect harmony, enabling everything from high-speed internet to autonomous vehicle communication and IoT integrations.

Synchronization in 5G, especially for wireless applications, hinges on stringent standards and technologies such as GNSS, PTP, SyncE defined by standard bodies such as 3gpp, ITU-T or IEEE. These foundational elements ensure that time-sensitive applications in a world increasingly reliant on digital and cloud services can operate without a hitch, marking a significant leap from previous generations of network technology.

In this eBook, we discuss the criticality of 5G synchronization across the main layers: transport, radio and resilience.



## First, Synchronization in the Lab

Synchronization is essential not only in challenging field environments, but also in the lab for developing new RAN infrastructure. The full suite of lab solutions allows developers to mitigate unforeseen challenges, accelerate development cycles, and simulate real-world conditions to safeguard subscriber QoE.

By simulating GPS signals consistently for R&D and QA applications, generating RF signals for jamming and interface testing, and verifying synchronization characteristics of Open RAN O-DUs without an O-RU present, we ensure comprehensive and reliable testing and development.

Additionally, the diverse GPS Clock/PLL (Phase Lock Loop) components can be utilized for precise synchronization circuits. With these tools, developers can build and test RAN infrastructure, ensuring performance and reliability in a safe lab environment.



# Mastering Transport Layer Dynamics



## Deploying 5G: Synchronization Use Cases and Challenges

Focusing on the transport layer for 5G synchronization, one notable use case involves deploying the [Full Timing Support \(FTS\)](#) protocol, G.8275.1, crucial for applications requiring stringent timing accuracy like cellular TDD services, virtual reality or autonomous driving. This standard ensures comprehensive timing support across the network but it's not without challenges. High-density urban environments, for instance, pose significant obstacles due to signal blockages and reflections, demanding advanced planning and deployment strategies to maintain synchronization integrity.

Another critical scenario is the deployment of [Partial Timing Support \(PTS\)](#) or Assisted Partial Timing Support (APTS), detailed in standard G.8275.2, suitable for environments where parts of the network may not be fully timing-aware. This scenario often arises in mixed-use networks involving legacy and modern infrastructure, introducing complexities in maintaining consistent timing which is vital for preventing signal interference and ensuring smooth service delivery.

Overcoming these challenges requires innovative synchronization solutions tailored to the unique demands of the 5G ecosystem



## Key Synchronization Technologies and Standards

Let's now explore the synchronization technologies pivotal for 5G transport: GNSS, Precision Time Protocol (PTP) and Synchronous Ethernet (SyncE).

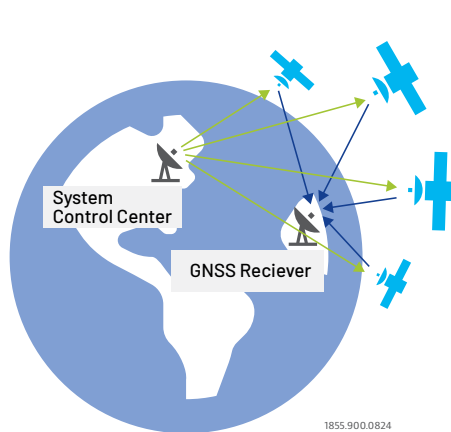

GNSS provides universal timing but its signal vulnerability in dense urban areas necessitates backup systems like PTP and SyncE.

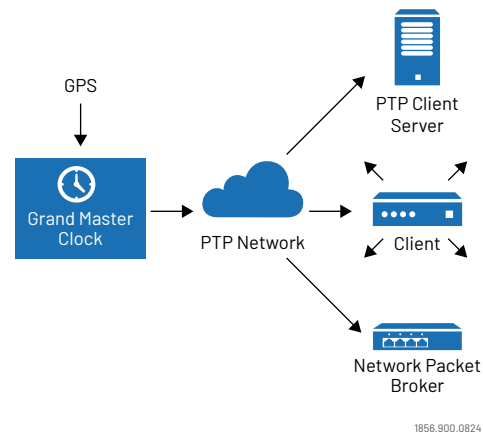

PTP, specified in standards such as G.8275.1 and G.8275.2, offers a flexible synchronization method capable of overcoming GNSS limitations by distributing time over packet networks.

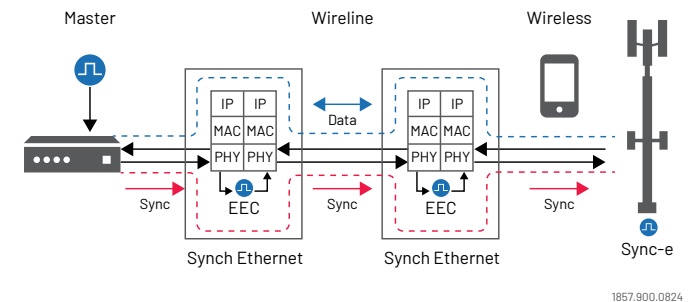

SyncE, complementing PTP, ensures frequency synchronization through the physical layer, crucial for maintaining the continuity and quality of service in 5G networks.

Together, these technologies form a powerful synchronization framework essential for the high-speed, low-latency demands of 5G transport.

## Testing to Ensure Precision in 5G Synchronization

Ensuring synchronization accuracy in 5G networks is not just about implementing the right technologies; it's also about rigorously testing these systems to uphold the stringent standards required for optimal performance.

The VIAVI [T-BERD/MTS-5800](#) and [OneAdvisor 800](#) enhanced with the [Timing Expansion Module \(TEM2\)](#) help customers achieve precision in 5G synchronization. The TEM2 Timing Module significantly enhances the capabilities of the T-BERD/MTS-5800 and OneAdvisor 800 by providing a field-optimized reference for timing and synchronization measurements. It includes a multi-band GNSS antenna and a Rubidium oscillator for high precision. This allows for nanosecond-accurate measurements essential in 5G synchronization, ensuring reliability and performance even without GNSS signal, utilizing holdover mode. The module supports multiple GNSS constellations and offers a range of outputs and interfaces for comprehensive synchronization testing.

These tools are instrumental in conducting PTP/SyncE/GNSS tests, aligning with ITU G.8265.1, G.8275.1, and G.8275.2 profiles for near-lab-grade accuracy in field conditions, empowering field engineers to tackle the complexities of 5G synchronization while ensuring network resilience and reliability.



Figure 1. T-BERD/MTS-5800 Platform

# Ensuring Radio Precision

# THE IMPORTANCE OF RADIO SYNCHRONIZATION

While 5G is yet to reach its full potential, deployments are picking up pace and it's set to be the dominant form of cellular connectivity within the next few years. In search of true optimization, synchronization becomes increasingly necessary, particularly under the rigorous standards set by 3GPP for 5G networks. These [standards](#) stipulate that time errors must be less than  $3\mu$  seconds ( $\pm 1.5\mu$  seconds) to ensure optimal functioning of the network.

## 5G Raises the Bar on Synchronization, Speed and Accuracy

Regardless of RU, DU, and CU location, Total Time Error between RU and the Grand Master cannot exceed  $1.5\mu$ s.

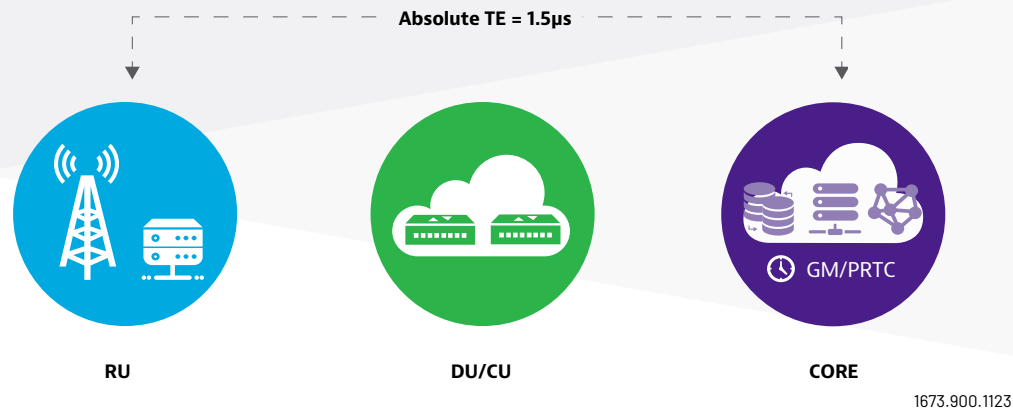

Figure 2. Time Error Between RU and the Grand Master

Such precision is crucial because even minor deviations can lead to significant disruptions in service quality and network reliability, affecting everything from data throughput to RF interference. In low-latency applications such as remote surgery or autonomous driving, even microseconds of time misalignment can lead to errors with serious consequences, so maintaining rigorous synchronization standards is crucial for enabling these time-sensitive applications to function reliably.

In addition to network efficiency, precise synchronization in 5G is integral for facilitating the seamless coexistence of various radio channel frequencies and service providers at the same location. As networks evolve to support a larger array of services, from high-definition video streaming to critical machine-to-machine communications, synchronization ensures that these diverse data streams do not interfere with one another. Effective synchronization minimizes the risk of data collision and timing discrepancies which are crucial to maintaining the integrity and reliability of real-time data transmission across the 5G network.

The need for accurate synchronization in 5G is especially pronounced given its use of [Time Division Duplex \(TDD\)](#) technology, where both uplink and downlink operations share the same frequency but are separated in time. Without precise synchronization, there's a high risk of RF interference, which can lead to a range of Quality-of-Service issues for end-users including decreased data rates and increased latency. This is why mobile operators are now keenly focused on implementing robust synchronization strategies as they roll out new 5G networks across the globe.

In the context of 5G radio access, the distinction between absolute and relative measurements plays a pivotal role in assessing timing and synchronization accuracy. Absolute measurements involve evaluating time errors across different channels simultaneously, providing a comprehensive overview of synchronization performance across networks. Conversely, relative measurements focus on comparing time errors between neighboring antenna sectors within the same network using physical cell identity (PCI) values to define each antenna's location. Understanding both types of measurements is crucial for ensuring optimal synchronization and minimizing RF interference which can disrupt signal transmission and degrade service quality.

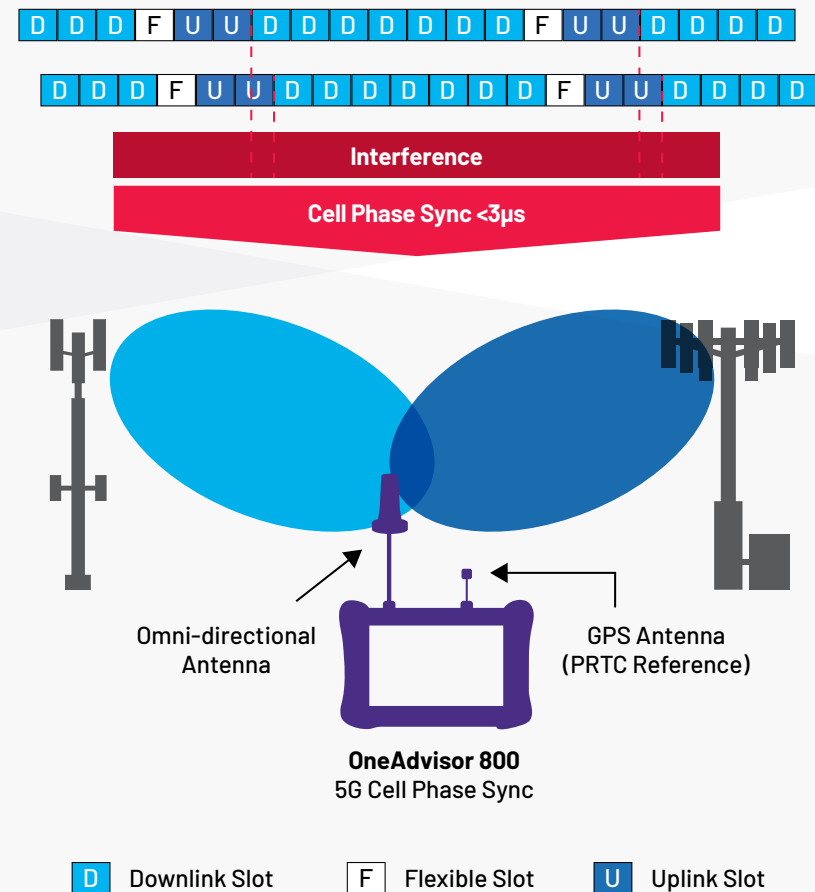

1854.900.0824

Figure 3. Timing and Synchronization with the Time Division Duplex (TDD)

## Challenges and Strategies in Deployment

Mobile operators deploying 5G face critical decisions on how to effectively synchronize their networks with common strategies involving the use of existing transport networks to distribute Precision Time Protocol (PTP) or the installation of GNSS receivers in the cell site. Each method ensures that synchronization signals are accurately relayed to and from 5G cell sites within the tight tolerances required. However, these methods are not without challenges as they must account for complex environments and varied geographical features that can disrupt synchronization signals.

The challenges are particularly pronounced in border areas where networks from neighboring countries may overlap – a common occurrence – leading to potential RF interference due to synchronization discrepancies. Operators must rigorously test and verify synchronization to ensure there are no time errors that exceed the designed error margins. This requires effective testing equipment and methodologies that can accurately assess synchronization across a network's transport and radio interfaces, ensuring seamless service delivery and adherence to international standards.



Operators must also consider the logistics of deploying and managing synchronization technologies over large and often geographically challenging environments. In urban areas for example, high-rise buildings and underground infrastructure can obstruct GNSS signals making it difficult to rely solely on satellite-based synchronization. This leads to a hybrid approach where both PTP delivered via the transport network and direct GNSS solutions are used together to ensure effective coverage.

What's more, the dynamic nature of new 5G services in the future, which range from ultra-reliable low-latency communications to massive machine-type communications, will place additional demands on synchronization accuracy. Each service type may require different synchronization parameters, adding layers of complexity to network design and management. Operators must deploy adaptable synchronization solutions that can meet these varied requirements effectively, ensuring seamless service delivery across all user scenarios.

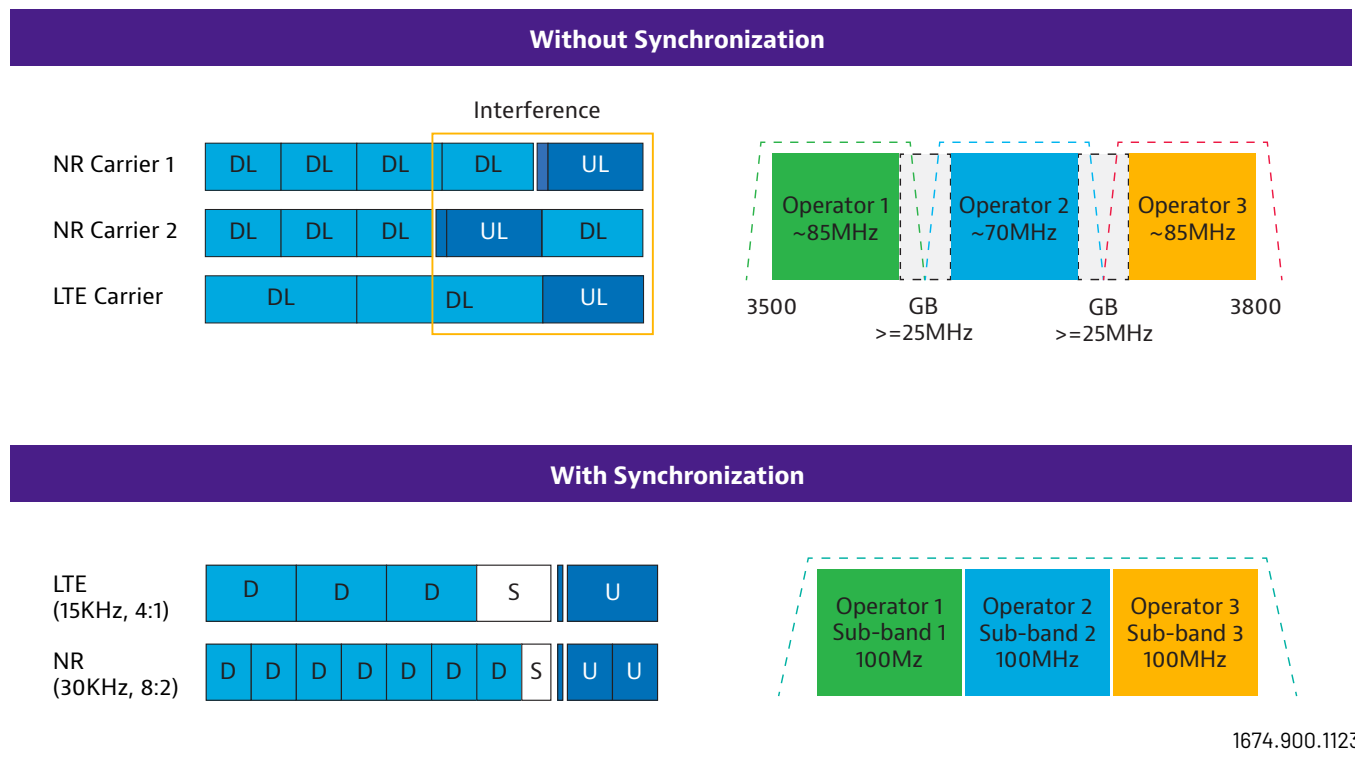

Figure 4. Frame Synchronization

## Solutions for Testing Radio Precision

To address the critical synchronization needs of 5G networks, VIAVI offers advanced tools like the [OneAdvisor 800](#), equipped with the [Timing Expansion Module \(TEM2\)](#). These devices are engineered to perform comprehensive timing and synchronization over-the-air (OTA) tests essential for 5G deployment. Their radio capabilities expand beyond the radio access and into assessing GNSS signals, evaluating PTP/SyncE performance, and conducting detailed frequency and time error validation across various network scenarios, ensuring that all synchronization specifications are met within the stringent limits set by industry standards. The TEM2 is particularly useful for indoor testing where there may not be GPS coverage.



Figure 5. Timing Expansion Module V2 (TEM V2) with T-BERD/MTS-5800 or OneAdvisor 800



## Navigating Time Synchronization Using PTP

Focusing on the transport layer for 5G synchronization, one notable use case involves deploying the [Full Timing Support \(FTS\)](#) protocol, G.8275.1, crucial for applications requiring stringent timing accuracy like cellular TDD services, virtual reality or autonomous driving. This standard ensures comprehensive timing support across the network but it also comes with challenges. High-density urban environments, for instance, pose significant obstacles due to signal blockages and reflections, demanding advanced planning and deployment strategies to maintain synchronization integrity.

Another critical scenario is the deployment of [Partial Timing Support \(PTS\)](#) or Assisted Partial Timing Support (APTS), detailed in standard G.8275.2, suitable for environments where parts of the network may not be fully timing-aware. This scenario often arises in mixed-use networks involving legacy and modern infrastructure, introducing complexities in maintaining consistent timing which is vital for preventing signal interference and ensuring smooth service delivery.

Overcoming these challenges requires innovative synchronization solutions tailored to the unique demands of the 5G ecosystem



# Strengthening Network Resilience



## The Role of STL in Achieving Network Resilience

Just as integral as radio and transport, resilience ensures that 5G networks can withstand some of the challenges posed by dense urban settings and other complex environments.

Network resilience is not merely about enduring disruptions, it's also proactively preventing synchronization failures that could cripple a 5G network. This resilience is crucial as it supports the network's ability to provide consistent, reliable service despite the varied challenges posed by urban environments such as high-density constructions and electronic interference.

Satellite Time and Location (STL) signals are a fundamental component of network resilience, providing a highly robust timing source that is less susceptible to interference and jamming compared to traditional GPS signals. STL operates via low Earth orbit (LEO) satellites that transmit highly secure, encrypted signals that are significantly stronger than those from traditional geostationary satellites. This strength allows STL signals to reach deeper into urban canyons and penetrate buildings more effectively, ensuring that 5G networks maintain precise synchronization even in challenging environments.

Choosing a vendor that offers a good STL service will ensure that networks benefit from a strong, consistent signal that enhances timing accuracy and penetrates challenging urban terrains

## Ensuring Resilience in the Staging Phase of 5G Deployment

The VIAVI [CLAW GPS Simulator](#) is a suitable tool during the staging phase of 5G deployments, particularly when RAN and core network equipment are tested indoors without access to real GPS signals. This simulator generates a controlled, synthetic GPS environment, allowing engineers to assess the resilience and accuracy of network components under simulated conditions that mimic real-world GPS availability. By providing a reliable and adjustable GPS signal, the CLAW ensures that all network equipment can maintain accurate timing synchronization crucial for seamless 5G operation.

The compact size and functionality of the VIAVI CLAW make it ideal for use in space-constrained indoor settings where traditional GPS signals cannot penetrate. Because it can be installed and operated with just a power supply, the CLAW is suited for indoor installations where network equipment needs a GPS feed to operate but an outdoor antenna is not available or not desired due to susceptibility to spoofing or jamming. It can then be synchronized through PTP network timing or indoor STL antenna, and UTC timing can be transferred to downstream equipment via L1 C/A GPS RF output signal.

The CLAW supports a wide range of testing scenarios, including the ability to test for GPS signal loss, interference and the transition between indoor and outdoor environments. This versatility makes it an essential tool for pre-deployment testing, ensuring that the network equipment will perform reliably in various operational conditions, thus safeguarding the quality of service upon actual deployment.



Figure 6. GPS Simulator/Transcoder Desktop Unit

## Managing Multiple Time Sources Across Various Network Elements

In 5G deployments, particularly with Open Radio Access Networks (ORAN), the challenge of maintaining precise synchronization across complex network architectures is critical. ORAN architecture – especially when configured to [specifications](#) like WG4 LLS Configuration 3 and LLS Configurations 1, 2 and 4 – demand highly accurate phase and frequency synchronization to support advanced 5G functionalities such as massive MIMO and network slicing. These requirements are stringent, necessitating a solution that can deliver and manage timing with exceptional precision and flexibility.

Addressing this need, the [VIAVI Qg 2 Multi-Sync Gateway and PTP Grandmaster](#) is specifically designed to support the synchronization demands of 5G ORAN, acting as a grandmaster that distributes timing signals across the network. The Qg 2 can manage multiple time sources and deliver synchronized time and frequency to various network elements efficiently. This ensures that all parts of the ORAN network operate in unison, reducing the potential for timing errors that could lead to service degradation or network failures. The device's capability to support various synchronization standards including ITU-T and IEEE protocols makes it versatile for different network deployment scenarios, including dense urban environments where signal interference is prevalent.



Figure 7. Qg 2 Multi-Sync Gateway and PTP Grandmaster

## Penetrating Urban Canyons

In modern urban settings, often referred to as “urban canyons,” the challenge of signal penetration is significant due to high-rise buildings and dense infrastructure. Traditional GNSS signals often fail to provide the necessary coverage and precision under these conditions, leading to potential gaps in network synchronization. This issue is particularly acute in 5G deployments, where the requirement for exact timing is non-negotiable for network functionality and service quality.

To combat these challenges, the VIAVI [SecurePNT™ 6200](#) platform powered by space and terrestrial SecureTimeSM services and TrustedPNT™ multisource fusion technology offers a solution by leveraging altGNSSSM GEO SecureTimeSM services and the STL signals, and efficiently converts these signals into 1PPS and TOD signals that feed directly into the PTP Grandmaster systems. Its ability to deliver precise timing information, even in environments where GNSS signals are compromised, ensures that 5G networks can maintain optimal performance and service delivery across various challenging urban landscapes. Equipped with a built-in CLAW functionality, legacy equipment can be quickly retrofitted simply by replacing existing antenna with the PNT unit. This helps minimize CAPEX and infrastructure investment.

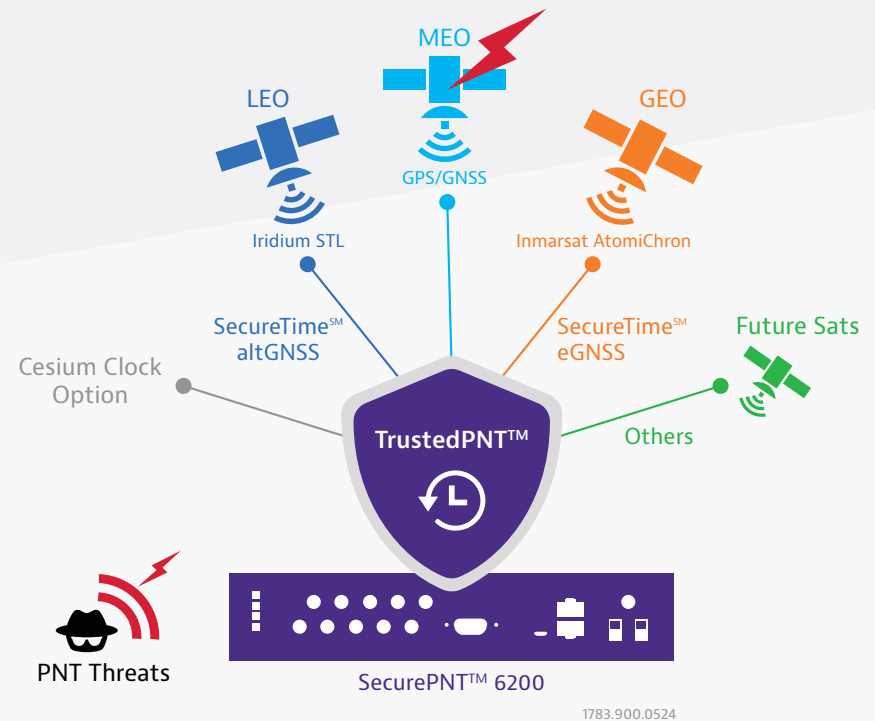

Figure 8. SecurePNT 6200 Powered with SecureTime Services

## Product Summary

At VIAVI, our advanced and comprehensive portfolio allows you to address synchronization performance consistently. With our solutions, we cover

### 5G Lab and Performance Testing:

[TM500 Wireless Network Tester](#)

[TeraVM](#)

### Radio Verification:

[OneAdvisor 800 Wireless](#)

### Resiliency:

[SecurePNT 6200](#)

### Transport:

[T-BERD/MTS-5800](#)

[TEM Timing Module](#)

[XhaulAdvisor](#)

As we wrap up our exploration of 5G synchronization, it's evident that resilience transcends functionality – it's the backbone of future-proof networks. VIAVI's comprehensive solutions not only tackle today's challenges but ensure that networks can be deployed to the standards that will be demanded tomorrow.







[viavisolutions.com](https://viavisolutions.com)

© 2024 VIAVI Solutions Inc.

Product specifications and descriptions in this document are subject to change without notice.  
Patented as described at [viavisolutions.com/patents](https://viavisolutions.com/patents)

xxx-xxx-xx-xxx-nse-ae  
30190000 900 0824